



The Truckee Meadows

Construction Site BMP Handbook



***Farr West Engineering
February 2015 Update***

TRUCKEE MEADOWS
CONSTRUCTION SITE BEST MANAGEMENT PRACTICES
HANDBOOK

February 2015 Update

Prepared For:

City of Reno

City of Sparks

Washoe County

Prepared By:

Farr West Engineering

Table of Contents

<i>List of Tables</i>	<i>iv</i>
<i>List of Appendices</i>	<i>iv</i>
<i>Acknowledgements</i>	<i>v</i>
<i>List of Acronyms</i>	<i>vi</i>

Section 1: Introduction1-1

1.1	Historical Background	1-1
1.2	What's New with the 2015 Update to the BMP Handbook?	1-2
1.3	What's in the new 2015 General Construction Permit?	1-2
1.4	Purpose of Handbook.....	1-3
1.5	Program Area	1-3
1.6	Overview of Handbook Organization	1-3
1.7	Updates and Revisions to the Construction Site BMP Handbook.....	1-4
1.8	Disclaimer	1-4
1.9	Comments	1-5
1.10	Distribution.....	1-5

Section 2: Storm Water Quality Management2-1

2.1	Environmental Impacts of Runoff from Construction Sites	2-1
2.2	Local Ordinances and Codes	2-3
2.3	The Watershed MapServer and the Truckee River Information Gateway.....	2-3
2.4	Best Management Practices (BMPs)	2-4
2.5	Principles of Erosion and Sediment Control	2-4
2.6	NPDES Permit Regulations	2-6
2.7	Nevada's General Permit for Construction Activity.....	2-6
2.8	Projects Requiring Coverage Under the General Permit	2-7
2.9	Permissible Non-Storm Water Discharges	2-7
2.10	References	2-8

Section 3: The Truckee Meadows Construction Site Discharge Program.....3-1

3.1	Local Program Requirements	3-1
3.2	Legal Authority.....	3-1
3.3	Performance Standards	3-3
3.4	Local Policies and Procedures.....	3-4
3.4.1	Plan Review	3-5
3.4.2	Inspection and Enforcement	3-6
3.4.3	Public Reporting.....	3-7
3.4.4	Public Resources	3-7

Table of Contents (cont'd)

Section 4:	Storm Water Pollution Prevention Plans	4-1
4.1	Who Must Prepare a SWPPP	4-1
4.2	SWPPP Components	4-1
4.3	Regional Program SWPPP	4-2
4.4	Pre-Construction Site Assessment	4-3
4.5	Detailed Site Map	4-3
4.6	Consistency with Other Regulations, Permits and Plans	4-4
4.7	303(d) Listed Pollutants of Concern and TMDLs	4-5
4.8	Selecting Construction Site BMPs	4-6
4.9	Inspection and Maintenance	4-7
4.10	Potential Enforcement Actions	4-8
4.11	Records Retention	4-8
4.12	References and Websites	4-9
Section 5:	Best Management Practices	5-1
5.1	Approved Construction Site BMPs for the Truckee Meadows	5-1
5.2	SWPPP Site Map Symbols	5-3
5.3	Straw Bale Barriers	5-8
5.4	Sizing Criteria for Sediment Retention Basins	5-8
5.5	References and Additional Resource Information	5-9
	5.5.1 Websites	5-10
Section 6:	Planning Best Management Practices	6-1
	Site Design PL-1	6-2
	Scheduling PL-2	6-4
	Phased Construction PL-3	6-6
	Phased Construction PL-3	6-7
	Native Material Reuse PL-4	6-9
	Employee Training PL-5	6-11
Section 7:	Runoff Control Best Management Practices	7-1
	Permanent Diversions RC-1	7-2
7.1		7-3
	Permanent Diversions RC-1	7-4
	Temporary Diversion Berms RC-2	7-5
	Temporary Diversion Berms RC-2	7-6
	Temporary Diversion Berms RC-2	7-7
	Temporary Diversion Berms RC-2	7-8
	Check Dams RC-3	7-9
	Check Dams RC-3	7-10
	Check Dams RC-3	7-11
	Check Dams RC-3	7-12

Table of Contents (cont'd)

Temporary Slope Drains	RC-4	7-13
Temporary Slope Drains	RC-4	7-15
Section 8:	Erosion Control Best Management Practices	8-1
Preserving Existing Vegetation	EC-1	8-2
Slope Terracing and Tracking	EC-2	8-4
Mulching	EC-3	8-6
Soil Binders	EC-4	8-9
Wind Erosion and Dust Control	EC-5	8-11
Rolled Erosion Control Products	EC-6	8-14
Section 9:	Sediment Control Best Management Practices	9-1
Fiber Rolls	SC-1	9-3
Brush and Rock Filters	SC-2	9-6
Sand & Gravel Bag Barriers	SC-3	9-8
Gravel Filter Berm	SC-4	9-11
Silt Fences	SC-5	9-13
Temporary Sediment Traps	SC-6	9-17
Sediment Retention Basins	SC-7	9-20
Construction Site Entrances & Exits	SC-8	9-26
Construction Exit Tire Wash	SC-9	9-31
Stabilized Construction Roadway	SC-10	9-34
Synthetic Sediment Control Rolls	SC-11	9-36
Section 10:	Drainageway Protection Best Management Practices	10-1
Temporary Stream Crossing	DP-1	10-2
Storm Drain Outlet Protection	DP-2	10-8
Storm Drain Inlet Protection	DP-3	10-11
Catch Basin Filters	DP-4	10-18
Section 11:	General Site and Materials Best Management Practices	11-1
Water Conservation Practices	GM-1	11-2
Stockpile Management	GM-2	11-4
Solid & Demolition Waste Management	GM-3	11-6
Dewatering Operations	GM-4	11-8
Street & Surface Cleaning	GM-5	11-14
Spill Prevention & Control	GM-6	11-16
Vehicle & Equipment Cleaning	GM-7	11-19
Vehicle & Equipment Maintenance & Fueling	GM-8	11-21
Handling & Disposal of Concrete & Cement	GM-9	11-24
Material Delivery, Handling, Storage & Use	GM-10	11-26
Paints & Liquid Materials	GM-11	11-28

Table of Contents (cont'd)

Pavement Construction Management GM-12.....	11-30
Liquid Waste Management GM-13.....	11-32
Sanitary/Septic Waste Management GM-14.....	11-34
Landscaping Management GM-15.....	11-36
Contaminated Soil & Water Management GM-16.....	11-38
Hazardous Waste Management GM-17.....	11-40
Illicit Discharges & Connections Detection & Reporting GM-18.....	11-42
Drilling & Pile Driving Operations GM-19.....	11-44
Material & Equipment Use Over Water GM-20.....	11-46
Structure Demolition/Removal Over or Adjacent to Water GM-21.....	11-48
Temporary Batch Plants GM-22.....	11-50

List of Tables

Table 2-1: Typical Construction Site Pollutants	2-2
Table 2-2: Basic Soil Types and Erosion Potentials	2-5
Table 2-3: Soil Surface Conditions at Construction Sites	2-6
Table 3-1: Existing Grading Regulations	3-2
Table 5-1: Approved Best Management Practices for Construction Sites	5-2
Table 5-2: Erosion Control Plan Symbols	5-4
Table 6-1: Planning Best Management Practices	6-1
Table 7-1: Runoff Control Best Management Practices.....	7-1
Table 8-1: Erosion Control Best Management Practices	8-1
Table 8-2: Soil Cover and Erosion Control.....	8-1
Table 9-1: Sediment Control Best Management Practices	9-2
Table 10-1: Drainageway Protection Best Management Practices	10-1
Table 11-1: General Site and Materials Management Best Management Practices	11-1

List of Appendices

- A 2015 General Construction Permit NVR100000
- B Notice of Termination (NOT)
- C Regional Program Storm Water Pollution Prevention Plan (SWPPP)
- D Regional Program Checklists – February 2015 Update
- E Regional Seed Mix Designs

Table of Contents (cont'd)

Acknowledgements

The 2013 Update of the Truckee Meadows Construction Site Best Management Practices (BMP) Handbook was prepared under a contract with the City of Reno on behalf of the Truckee Meadows Storm Water Permit Coordinating Committee. The 2013 committee members were:

Terri Svetich, P.E., Program Coordinator
City of Reno, Sanitary Engineering

Walter West, P.E.
Washoe County Community Services Dept.
- Engineering and Capital Projects Division

Bill Gall, P.E.
City of Reno, Community Development

Christian Kropf
Washoe County Community Services Dept.
- Engineering and Capital Projects Division

Tobey Ebens
City of Sparks, Community Services Dept.

Andy Hummel, P.E.,
City of Sparks, Community Services Dept.

Susan Ball Rothe, Legal Counsel
City of Reno, Deputy City Attorney

This BMP handbook was developed to assist the Cities and County and members of public involved in the planning, design and construction of private and public new development and redevelopment projects with the requirements set forth in the Nevada 2015 General Construction Permit (NVR100000). The Nevada Division of Environmental Protection (NDEP) issued this permit in compliance with the provisions of the Federal Clean Water Act and Chapter 445A of the Nevada Revised Statutes (NRS). The NDEP staff members responsible for developing and implementing the permit, and reviewing the Construction Site BMP Handbook were:

Clifford Lawson, P.E.
Technical Services Supervisor
NDEP, Bureau of Water Pollution Control

Steve McGoff, P.E.
Staff Engineer
NDEP, Bureau of Water Pollution Control

The following staff members at Farr West Engineering were responsible for updating this BMP handbook: Candice Elder and Brent Farr, P.E. In addition, Julie Etra, CPESC, Western Botanical Services assisted with the updates.

List of Acronyms

BAT	Best Available Technology Economically Achievable
BCT	Best Conventional Pollutant Control Technology
BMP	Best Management Practices
BOD	Biological Oxygen Demand
Caltrans	State of California Department of Transportation
DI	Drop inlet (storm drain catch basin)
EPA	U. S. Environmental Protection Agency
EOS	Equivalent Opening Size
LID	Low Impact Development
MS4	Municipal Separate Storm Sewer System
MSDS	Material Safety Data Sheet
NDEP	Nevada Division of Environmental Protection
NDF	Nevada Division of Forestry
NDOT	Nevada Department of Transportation
NOI	Notice of Intent
NOT	Notice of Termination
NOV	Notice of Violation
NPDES	National Pollutant Discharge Elimination System
NRC	National Response Center
NRCS	Natural Resource Conservation Service
RSWQMP	Regional Storm Water Quality Management Program
SWPPP	Storm Water Pollution Prevention Plan
VOC	Volatile Organic Chemicals
WSCD	Washoe-Storey Conservation District

Section 1: Introduction

1.1 Historical Background

In January 2000, the Nevada Division of Environmental Protection (NDEP) issued a Large Municipal Separate Storm Sewer System (MS4) Permit to the Cities of Reno and Sparks, Washoe County, and the Nevada Department of Transportation (the Truckee Meadows permittees). One of the conditions of the Truckee Meadows MS4 permit was to develop and implement a Regional Storm Water Quality Management Program (RSWQMP) for reducing pollution in municipal storm water discharges in the Truckee Meadows. In September 2001, the RSWQMP was adopted by the Truckee Meadows Storm Water Permit Coordinating Committee, consisting of a representative from each of the four permittees. The RSWQMP called for the development of nine program elements to address the requirements of the permit, including a regional Construction Site Discharge Program. Each individual permittee is responsible under this program for its own ordinances, permitting and inspection of construction sites. The program includes the development, adoption and implementation of a Construction Site Best Management Practices (BMPs) Handbook. The 2003 version of this handbook was developed for the Cities of Reno and Sparks and Washoe County, with funding provided by the Regional Water Planning Commission. The fourth permittee of the 2000 Truckee Meadows MS4 Permit, the Nevada Department of Transportation (NDOT), independently developed its own Construction Site BMP Manual for statewide use at NDOT constructions.

In June 2002, the Storm Water Permit Coordinating Committee, began the process of developing a regional Construction Site Discharge Program. In September 2002, NDEP issued a General Permit for Stormwater Discharges Associated with Construction Activity (NVR100000). This permit, hereinafter referred to as the General Construction Permit, presents specific requirements for the owners and operators of all applicable private and public construction sites in the State of Nevada to control erosion, sediment and waste discharges to the municipal storm drain system. On January 5, 2015, the new General Construction Permit became effective.

To develop the Construction Site Discharge Program and the Construction Site BMP Handbook, the committee conducted a series of public meetings and workshops to discuss the following:

- NDEP's new storm water program for construction activities and the U.S. Environmental Protection Agencies (EPA) requirements for a local program.
- Construction Site Discharge programs in other communities.
- Development of local performance standards.
- The format of the Construction Site BMP Handbook and a recommended suite of BMPs for erosion, sediment and waste control at construction sites.
- Development of local policies and procedures.
- Concurrent activities of NDEP and EPA, other related local programs.
- Comments and concerns of the general public.

The first Truckee Meadows Construction Site BMP Handbook, dated February 2003, was adopted by the Cities of Reno and Sparks and Washoe County. Over the next several years, the Cities and the County developed storm water inspection programs for construction and industrial sites and together with NDEP, they also conducted a number of public workshops for local agency staff and construction site contractors. In addition, the NDEP adopted the model SWPPP template developed for the Truckee Meadows and also developed an online filing system for the electronic submission of the Notice of Intent (NOI) form to obtain coverage under the 2015 General Construction Permit. Concurrently with the update of this BMP handbook, the Nevada Contractors Field Guide for Construction Site BMPs was updated, and the Structural Controls Design Manual and LID Handbook were combined.

1.2 What's New with the 2015 Update to the BMP Handbook?

The 2013 update to the Truckee Meadows Construction Site BMP Handbook includes the following new additions:

- Updated contact information for Public Resources to assist with BMPs and SWPPPs.
- Updated information for existing BMP fact sheets.
 - Proper use, changes in use, proper installation, relevance, etc.
- Updated seed mixes and fire resistant seed mixes.

1.3 What's in the new 2015 General Construction Permit?

The 2015 NDEP General Permit has been streamlined and revised for clarity and function. Some of the significant changes in this permit include:

- A Notice of Intent (NOI) must be submitted 14 days prior to ground disturbing activities (the previous permit was 48 hours prior with 30 days to submit certification page and fees). This will allow for certification page and fees to be processed by NDEP prior to ground disturbing activities. There is no provisional coverage.
- The construction waiver for sites between 1 and 5 acres in size and with an erosivity factor < 5 (R) were able to qualify for this waiver. The new permit has removed this option and requires ALL disturbances of 1 acre or greater, that discharges to a designated waterway, to obtain permit coverage.
- The definition of Owner/Operator is clear and discusses the responsibility of the Owner if a contractor (operator) defaults on permit requirements.
- All permitted sites must have a sign posted on the site showing the CSW# and responsible party contact information (similar to the dust signs that are around).
- Certain allowable non-stormwater discharges that were allowed in the old permit are not allowed in the new one. These discharges may need a Diminimus Permit NVG201000.
- A reduced BMP inspection schedule may be approved (from the once a week) if certain criteria are met (Part 5.3.1 of the permit). If a site meets all the requirements in Part 5.3.1, the operator shall inspect the site at least Once every 30 days and within 24 hours of a 0.5 inch storm or greater.

- The SWPPP requires a “Stormwater Team” (Part 6.2.2). Stormwater Team is defined as “an individual or group of individuals responsible for oversight of the development and modification of the SWPPP, and oversight of compliance with the permit requirements.”

1.4 Purpose of Handbook

The primary purpose of the Construction Site BMP Handbook is to assist local users with the requirements of NDEP’s 2015 General Construction Permit and the local policies developed in response to the permit requirements. It is also intended to provide a comprehensive document that includes copies of all forms, checklists, storm water quality management information, regulatory information and the BMP standards and specifications necessary to comply with federal and state NPDES General Construction Permits and applicable local erosion and sediment control requirements. The BMPs presented in the handbook were carefully selected to provide a wide variety of appropriate controls appropriate for use with the soils and climate of the Truckee Meadows. The intended users of the handbook include the owners/operators of construction sites, developers, design engineers, contractors and plan review and construction site inspection staff from the Cities of Reno and Sparks and Washoe County.

1.5 Program Area

The Truckee Meadows Construction Site Discharge Program applies to construction activities within the Cities of Reno and Sparks and Washoe County. Per the Truckee Meadows MS4 Permit issued jointly to the Cities and County in January 2005, “The permitted area includes the limits of the urbanized area within the Truckee Meadows Service Area as established by the Truckee Meadows Regional Planning Agency.” this permit covers discharges into receiving waters of the United States within this defined area. The receiving waters of the United States in the Truckee Meadows include, but are not limited to, the Truckee River, Silver Lake Playa, Swan Lake Playa, Whites Lake Playa and the tributaries that drain to these water bodies.

1.6 Overview of Handbook Organization

The Construction Site BMP Handbook is organized as follows:

- Section 1 provides the history and purpose of the Construction Site BMP Handbook and its organization.
- Section 2 introduces the concept of storm water quality management, the environmental impacts of runoff, the EPA storm water program, and the NDEP 2015 General Construction Permit.
- Section 3 provides information on the Truckee Meadows Construction Site Discharge Program, the legal authority of NDEP and local agencies to conduct inspections and enforcement actions, local performance standards and policies and procedures.
- Section 4 provides information about who must prepare a SWPPP, its basic components, recommended pre-construction site assessment procedures, and guidance for completing the model SWPPP and selecting BMPs.

- Section 5 presents the list of preferred BMPs for use at construction sites in the Truckee Meadows, BMP map symbols for site maps and additional resource information.
- Sections 6 through 11 present a series of BMP fact sheets for Planning, Runoff Control, Erosion Control, Sediment Control, Drainageway Protection, and General Site and Materials Management, respectively. Detailed information on the purpose, application, limitations, standards and specifications, inspection and maintenance requirements of each BMP is provided.
- Appendix A provides a copy of NDEP's 2015 General Construction Permit (NVR100000).
- Appendix B provides a copy NDEP's Notice of Termination (NOT) form (Please note that the NDEP NOI forms are now available online at <http://ndep.nv.gov/bwpc/storm01.htm>).
- Appendix C provides a blank copy of the model SWPPP to be used by Owners/Operators throughout the state.
- Appendix D provides blank copies of the local procedural checklists that will be used when applying for any type of construction permit and the checklist that will be used to inspect construction sites.

1.7 Updates and Revisions to the Construction Site BMP Handbook

The US Environmental Protection Agency (USEPA) requires owners and operators of construction sites to use the Best Available Technology Economically Achievable/Best Conventional Pollutant Control Technology (BAT/BCT) to control erosion, sediment and wastes. This technology is new and evolving with new improved and innovative BMPs rapidly being developed. In order to meet the BAT/BCT standard, the permittees will periodically review and potentially approve new or innovative BMPs and periodically add new BMPs to the regional storm water website www.TMstormwater.com as well as retire those that are ineffective or counterproductive. In addition, the permittees will review and update the Construction Site BMP Handbook every five years, concurrent with NDEP's five-year NPDES storm water permit cycle. The review process will consist of two tasks; a technical review of the new BMPs used locally and by other communities, and recommended by the USEPA; and a procedural review of how well the Construction Site BMP Handbook is being applied in the Truckee Meadows. Design engineers and contractors, as well as agency review and inspection staff, will be interviewed to determine potential deficiencies and to suggest improvements.

1.8 Disclaimer

The Truckee Meadows Construction Site BMP Handbook is used as a guidance document to minimize erosion and polluted runoff from construction sites and is a dynamic document that will be reviewed and updated periodically with new practices and technologies. The controls and performance standards described herein are intended to serve as minimum control standards or Best Management Practices (BMPs). BMPs are used to assist with consistent regulation of construction activities by applying a uniform standard. Not all of the control practices noted in this handbook are necessary or appropriate for all construction sites. Proper training is

recommended prior to preparing SWPPPs and installing, inspecting and maintaining the BMPs described herein.

1.9 Comments

Comments and questions on the Truckee Meadows Construction Site BMP Handbook and the Regional Storm Water Quality Management Program may be directed to:

Storm Water Program Coordinator
The City of Reno Public Works Department
P.O. Box 1900
Reno, Nevada 89505

Phone: (775) 334-2350

Website: www.TMstormwater.com

1.10 Distribution

Copies of the Truckee Meadows Construction Site BMP Handbook can be obtained from the Public Works Departments of the Cities of Reno, Sparks and Washoe County. A PDF version of the BMP handbook can also be downloaded at www.TMstormwater.com

Section 2: Storm Water Quality Management

2.1 Environmental Impacts of Runoff from Construction Sites

Erosion and sediment transport are natural processes that form landscapes and provide the bedloads required to maintain stable streams and rivers. Sediment and gravel transported from undeveloped land surfaces also provides important fish spawning medium and is critical to support other aquatic, riparian and terrestrial habitats. Disturbances within watersheds from activities such as construction, mining and overgrazing can greatly accelerate the process of erosion and sediment transport, resulting in excessive deposition of sediments in streams and rivers, and other negative environmental impacts.

The majority of the urbanized area in the Truckee Meadows is located in watersheds that drain to the Truckee River and its tributaries. The river supports numerous plant and animal species as well as providing a major local source of high quality drinking water. It also provides significant socioeconomic, recreational and aesthetic benefits. Protection of the Truckee River and its tributaries from potential negative impacts, such as degradation from improperly managed construction activities, is of critical concern to many of the residents of the Truckee Meadows.

Degradation of Aquatic and Riparian Ecosystems: Excessive sediment loads from runoff can cause increased turbidity and reduced light penetration resulting in reduction in prey capture for sight feeding predators, clogging of gills and filters of fish and aquatic invertebrates, reduced spawning and juvenile fish survival, reduced angling success, smothering of bottom dwelling communities, changes in substrate composition, and reduction in aesthetic values (Schueler, 1987). Sediments from runoff can also lead to suppression of both aquatic and terrestrial vegetation and may add nutrient particles and other pollutants to lakes and streams. In addition, increased sediment loading can result in changes to the physical characteristics of streams and rivers. Changes may include streambed degradation, stream widening, and streambank erosion (Urban Drainage and Flood Control District, 1999).

Pollution Transport: Sediment is a pollutant in its own right and can transport many substances (such as nutrients, hydrocarbons, and trace metals) and lead to water pollution problems (APWA, 1981). Soil organic components, plant residues, nutrient elements, organic material, atmospheric pollutants, and liquid and solid wastes are pollutants that originate from topsoil losses. Construction activities remobilize pollutants in sediment and often add additional pollutants that adhere to the soil particles. Table 2-1 provides a list of the typical pollutants associated with construction site activities.

Erosion and Sedimentation of Waterways and Public Facilities: Construction activities almost always increase the amount of impervious area causing increased runoff and quicker flood peaks. Unless properly managed, this increased runoff will erode material and/or unprotected watercourses causing channel widening and/or deepening, which will persist until the channel re-establishes equilibrium. Erosion of watercourses may potentially result in property damage. Sedimentation also contributes to accelerated filling of reservoirs and drainage systems, resulting in additional maintenance requirements and increased expenditure of private and public funds.

Table 2-1: Typical Construction Site Pollutants

CATEGORY	PRODUCT/ ACTIVITY	POLLUTANTS
Adhesives	Adhesives, Glues, Resins, Epoxy Synthetics Caulks, Sealers, Putty, Sealing Agents Coal Tars (Naptha, Pitch)	Phenolics, Formaldehydes Asbestos, Phenolics, Formaldehydes Benzene, Phenols, Naphthalene
Cleaners	Polishes (Metal, Ceramic, Tile), Etching Agents Cleaners, Ammonia, Lye, Caustic Sodas, and Bleaching Agents Chromate Salts	Metals Acidity/Alkalinity Chromium
Plumbing	Solder (Lead, Tin), Flux (Zinc Chloride) Pipe Fitting (Cut Shavings) Galvanized Metals (Nails, Fences) Electric Wiring	Lead, Copper, Zinc, Tin Copper Zinc Copper, Lead
Painting	Paint Thinner, Acetone, MEK, Stripper Paints, Lacquers, Varnish, Enamels Turpentine, Gum Spirit, Solvents Sanding, Stripping Pigments, Dyes	Volatile Organic Chemical (VOCs) Metals, Phenolics, Mineral Spirits VOCs Metals Metals
Woodwork	Sawdust Particle Board Dusts Treated Woods	Biological Oxygen Demand (BOD) Formaldehyde Copper, Creosote
Masonry & Concrete	Dusts (Brick, Cement) Colored Chalks (Pigments) Concrete Curing Compounds Glazing Compounds Cleaning Surfaces	Acidity, Sediments Metals Alkalinity Asbestos Acidity
Floors & Walls	Flashing Drywall Tile Cutting (Ceramic Dusts) Adhesives	Copper, Aluminum Sediments Minerals Phenolics, Formaldehydes
Remodeling & Demolition	Insulation Venting Systems Brick, Cement, Saw Cutting, Drywall	Asbestos Aluminum, Zinc Sediments
Air Conditioning & Heating	Insulation Coolant Reservoirs Adhesives	Asbestos Freon Phenolics, Formaldehydes
Yard Operation and Maintenance (O&M)	Vehicle and Machinery Maintenance Gasoline, Oils, Additives Marking Paints (Sprays) Grading, Earth Moving Portable Toilets Fire Hazard Control (Herbicides) Pest Control Wash Waters	Oils and Grease, Coolants Benzene & Derivatives, Oils & Grease Vinyl Chloride, Metals Sediments BOD, Disinfectants, pathogens Sodium Arsenite, Dinitro Compounds Rodenticides, Insecticides Herbicides, Concrete, Oils, Greases

Table 2-1: Typical Construction Site Pollutants

CATEGORY	PRODUCT/ ACTIVITY	POLLUTANTS
Landscaping Earthmoving Erosion control	Planting, Plant Maintenance Excavation, Tiling Masonry & Concrete Solid Wastes (Trees, Shrubs, Green Waste, Mulch) Exposing Mineral Deposits Soils Additives Fertilizers	Pesticides, Herbicides, Fertilizer Sediment Alkalinity BOD Acidity/Alkalinity, Metals Aluminum Sulfate, Sulfur Nutrients Geotextiles Plastic netting
Materials & Waste Storage	Waste Storage Hazardous Waste Containment Raw Material Piles	Used Oils, Solvents, Solid Waste See above categories See above categories

References: USEPA, 1973; Meech and Bazany, 1991; Gosselin, et. al., 1984.

2.2 Local Ordinances and Codes

A number of watershed and hydrologic studies have been conducted in the Truckee Meadows over the past ten years to assess the physical, biological and water quality aspects of the areas streams and creeks. Local ordinances and codes are based upon the standards for Construction Site Stormwater protection shown in the Truckee Meadows handbook. Following and meeting or exceeding these standards translate to contractors and project owners remaining in compliance with federal and state permits and laws, as well as local ordinances, avoiding penalties and potential monetary fines.

2.3 The Watershed MapServer and the Truckee River Information Gateway

Perennial streams in the Truckee Meadows area can be identified using topographic maps developed by the United States Geological Survey (USGS). They can also be identified using the City of Reno’s Watershed MapServer (<http://maps.cityofreno.net/watershed/>). This Watershed MapServer includes user friendly GIS tools which can be used to locate and zoom in on the perennial streams tributary to the Truckee River within the Truckee Meadows area. The Watershed MapServer is intended to provide a mechanism to educate and connect citizens to their local creeks and to assist developers and planners in understanding their projects potential impacts to creeks and watersheds. At the time of this writing, the Watershed MapServer includes a series of photos of different reaches of the Truckee River. The City of Reno intends to expand the information available on the Watershed MapServer to include photos of the tributaries to the river, stream zone buffer areas, 303(d) listed pollutants of concern, and information about the regulatory agencies that have permitting authority over specific river and

stream reaches. To compliment this effort, monitoring data for the river and its tributaries can be found via the [Truckee River Information Gateway](http://www.truckeeriverinfo.org/) (TRIG) (<http://www.truckeeriverinfo.org/>).

2.4 Best Management Practices (BMPs)

A BMP can be defined as any program, technology, process, siting criteria, operating method, measure, or device that controls, prevents, removes, or reduces water pollution (IECA, 2002). Construction site BMPs are generally implemented to reduce or prevent erosion and to control the sediment and wastes that are generated from construction activities and transported in storm water.

2.5 Principles of Erosion and Sediment Control

Erosion control practices focus on protecting soil surfaces and preventing the particles from being detached by wind or rain, whereas sediment control practices trap the soil particles after they have been dislodged and moved by wind or water (CA RWQCB, 1999). Erosion control is considered more efficient and cost effective than sediment control because they keep soils in place and don't require costly sediment removal. The combined use of these two best management practices is often required at construction sites to reduce and eliminate pollution in storm water discharges.

Natural drainage (preservation of vegetation and grade) is the most effective means of filtering sediment and pollution and regulating the volume of runoff from land surfaces adjacent to streams (CA RWQCB, 1999). When it is not possible to maintain a natural state, sediment runoff from disturbed surfaces can be reduced significantly through the use of soil stabilization practices, sediment barriers and controls, and the stabilization of vehicle access roads. Some of these practices are temporary and only remain in effect during construction. Others are permanent and remain after construction is completed or until the site is stabilized or re-vegetated. Figure 2-1 provides a comparison of sediment concentrations in storm water runoff discharged from sites with various levels of controls in place.

Limiting the amount of disturbed soil area is also a critical component of an effective storm water management program. Some agencies place limitations on the amount of total disturbed soil area each project can expose until either temporary or permanent erosion control measures are in place. For example, Caltrans' Standard Specifications state that "Unless otherwise approved by the Engineer in writing, the Contractor shall not expose a total area of erodible earth, which may cause water pollution, exceeding 70,000 m² (approximately 17.3 acres) for each separate location, operation or spread of equipment before either temporary or permanent erosion control measures are accomplished" (Caltrans, 2000). Limitations on the amount of continuous disturbed soil area are also important, particularly on exposed slopes. Slope length and inclination are considered the most important criteria for soil stabilization and sediment control, because these two factors have the largest potential impact on erosion rates. Slope lengths can be limited by installing measures that effectively break up the slope length, reduce runoff velocities and trap sediments. Terraces and linear sediment barriers such as fiber rolls can be implemented for this purpose.

Different soil types and soil surfaces also influence erosion potential. Table 2-2 presents the erodibility classification of several different basic soil types. Soil erodibility is the propensity for

soil particles to become detached by the erosive actions of water and wind. It is also a function of soil texture, organic matter content, soil structure and permeability, vegetation, and other types of surface cover such as gravel.

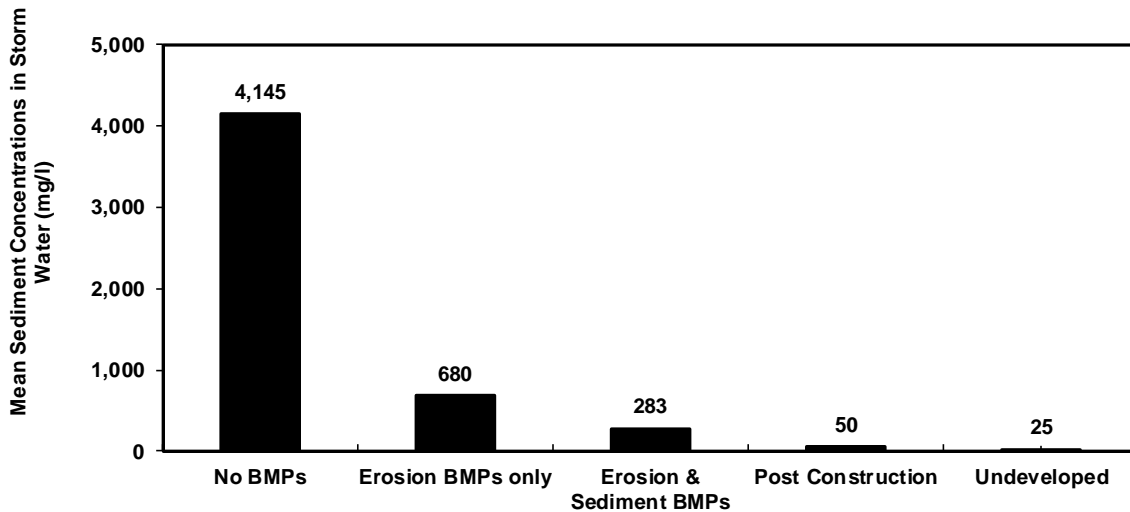

Figure 2-1. Effects of erosion and sediment control measures on suspended sediment concentrations from construction sites (Schueler and Lugbill, 1990).

Table 2-2: Basic Soil Types and Erosion Potentials	
Soil Type	Erodibility Classification
Low-Plasticity Silt	Most Erodible ↓ Least Erodible
Silty Sand	
Clayey Sand	
High-Plasticity Silt	
Low-Plasticity Organic Soil	
Low-Plasticity Clay	
High-Plasticity Clay	
Silty Gravel	
Well-Graded Sand	
Poorly Graded Gravel	
Well-Graded Gravel	
Reference: Fifield, 2002	

Table 2-3 presents a comparison of soil surface conditions at construction sites and the impact on increasing or reducing erosion potentials. Land management practices or techniques that roughen soil surfaces and disrupt sheet flow effectively act to reduce the velocity of runoff waters, reduce erosion potentials, enhance infiltration and promote the establishment of vegetation. Shielding soil surfaces with covers, such as mulches, enhances soil roughening effectiveness, protects disturbed soils and helps to preserve soil moisture, further enhancing the revegetation success. Best management practices that can be effectively used to reduce erosion at construction sites are presented in Section 8.

Table 2-3: Soil Surface Conditions at Construction Sites	
Soil-Surface Condition	Impact on Erosion
Compacted and Smooth	+30%
Track walked along contours	+20%
Track walked up and down slope	-10%
Sparse crimped straw	-10%
Loose to 12 inches in depth	-20%
Reference: Goldman et al., 1986	

2.6 NPDES Permit Regulations

In 1987, Congress amended the Federal Water Pollution Control Act (also known as the Clean Water Act) in order to protect receiving water bodies from the impacts of urban runoff. The amendments established a framework for regulating municipal and industrial discharges under the National Pollutant Discharge Elimination System (NPDES). Sources of storm water runoff that had the greatest potential to negatively impact water quality nationwide were addressed by Phase I of the NPDES Storm Water program. Construction sites are considered one of the eleven regulated industrial activities. Under Phase I, the U.S. Environmental Protection Agency (EPA) required NPDES permit coverage for storm water discharges from medium and large municipal separate storm sewer systems (MS4s) located in incorporated places or counties with populations of 100,000 or more. In March 2003, Phase II of the NPDES Storm Water program became effective. In addition to requiring permit coverage for storm water discharges from certain regulated small MS4s, Phase II lowered the threshold for construction activities regulation from 5 acres to 1 acre of land disturbance.

2.7 Nevada’s General Permit for Construction Activity

The NPDES program is a national permit program designed to regulate point source discharges to the waters of the U.S. NPDES storm water discharge permits are required for certain activities by EPA regulations [40 CFR § 122.26(b)(14)]. In compliance with these regulations, the Nevada Division of Environmental Protection (NDEP) has issued five general stormwater permits. They are: (1) the Large Municipal Separate Storm Sewer System (MS4) Permits issued to the Truckee Meadows and the Clark County permittees, (2) the Small MS4 General Permit, (3) the General Discharge Permit for Industrial Activity, (4) the General Discharge

Permit for Mining Activity, and (5) the General Permit for Stormwater Discharges Associated with Construction Activity (referred to in this handbook as the General Construction Permit). This manual focuses on NDEP's 2015 General Construction Permit (NVR100000). A copy of the current permit is presented in Appendix A.

NDEP's 2015 General Construction Permit requires the owner/operator of all applicable private and public construction sites statewide to submit to a NOI, an annual fee, and to develop and implement a SWPPP that includes erosion, sediment and waste control measures, self-inspection, monitoring and reporting. The SWPPP must be prepared prior to submittal of the NOI and is not to be submitted to NDEP, but must remain on the project site during the duration of the project. The annual fee is due when the NOI is initially filed and on or before July 1 every year. When construction is complete and all disturbed soils are stabilized, the site owner/operator is required to submit a NOT to NDEP. Copies of NDEP's NOI and NOT forms are presented in Appendix B. A model SWPPP, which provides the preferred format for use in the Truckee Meadows, is presented in Appendix C. Guidance on preparing and implementing a SWPPP is presented in Sections 4.0 and 5.0.

2.8 Projects Requiring Coverage Under the General Permit

Construction sites that will require permit coverage under NDEP's 2015 General Construction Permit include the following:

- Any construction activity including clearing, grading, excavation, and demolition that disturbs one or more acres of land.
- Any land disturbance on a site that is part of a larger common plan of development or sale with a planned disturbance of one acre or greater.
- All temporary plants or operations set up to produce concrete, asphalt or other materials for a permitted construction project (does not apply to commercial operations or those that serve multiple projects).
- Any repaving operation of one or more acres that creates fine-grained sediments that are not immediately removed from the site and properly disposed of at an acceptable facility (although not specified in the 2015 General Construction Permit or 40 CFR 122.26, NDEP has the authority to enforce this additional requirement).
- Any construction activity, including sites disturbing less than one (1) acre that are designated by the NDEP or the EPA to have a potential for contribution to a violation of a water quality standard or may significantly contribute pollutants to waters of the United States. This includes construction projects that may impact receiving waters within a ¼ mile radius of the project.

2.9 Permissible Non-Storm Water Discharges

Per section 1.2.3 of the NDEP 2015 General Construction Permit, an operator may discharge the following non-storm water discharges, provided they are not a significant source of pollutants and the operator implements the appropriate BMPs to minimize pollutants:

- Discharges from fire-fighting activities.
- Fire hydrant flushing.

- Water used to wash vehicles where detergents are not used.
- Water used to control dust, provided effluent or other wastewaters are not used.
- Routine external building wash down where detergents are not used.
- Pavement wash waters where spills or leaks of toxic or hazardous materials have not occurred (unless all spilled material has been removed) and where detergents are not used.
- Uncontaminated air conditioning or compressor condensate.
- Water used for compacting soil, provided effluent or other wastewaters are not used.

The new 2015 General Permit, NVR100000 does not allow as many discharges as the previous permit allowed, and instead has directed these discharges to be effectively regulated under the separately issued DeMinimis General Permit, NVG201000.

Note: Some of these non-storm water discharges or flows may require regulation, mitigation, or elimination if they contribute significant pollutants to the storm drain system or receiving water bodies. For example, it is not permissible to wash sediment tracked onto local roadways from a construction site into the storm drain system (storm drain inlet protection BMPs must first be installed - see BMP fact sheet DP-3). Although discharges from fire-fighting activities may contain significant pollutant concentrations, this activity is relatively infrequent and is allowed to occur out of necessity to protect public health and safety. While treated waste water effluent (a.k.a. reclaimed water) is commonly used for dust control, it is not permissible to directly discharge treated effluent to the storm drain system.

2.10 References

- APWA, 1981. Urban Stormwater Management, Special Report No. 49, American Public Works Association Research Foundation.
- California Regional Water Quality Control Board, 1999. *Erosion and Sediment Control Field Manual*, San Francisco Bay Area Region, 3rd Edition, July 1999.
- Caltrans, 2000. *Construction Site Best Management Practices (BMPs) Manual*. State of California, Department of Transportation, November 2000.
- Fifield, J. S., 2002. *Field Manual on Sediment and Erosion Control Best Management Practices for Contractors and Inspectors*, ForesterPress, Santa Barbara, CA.
- Goldman, S., K. Jackson, and T. Bursztynsky, 1986. *Erosion and Sediment Control Handbook*. McGraw-Hill Book Company, New York, NY.
- Gosselin, R., R. Smith, and H. Hodge, 1984. *Clinical Toxicology of Commercial Products*, Fifth Ed. Williams and Wilkins, Baltimore/London.
- International Erosion Control Association (IECA), 2002. *Workbook: How to Select, Install and Inspect Construction Site Erosion and Sediment Control BMPs for NPDES Storm Water Permit Compliance*.

- Meech, M. and M. Bazany, 1991. *Construction Creates Own Set of Hazardous Wastes*. Hazmat World. August, 1991.
- Schueler, T. and J. Lugbill. 1990. *Performance of Current Sediment Control Measures at Maryland Construction Sites*. Occoquan Watershed Monitoring Lab and Metropolitan Washington Council of Governments. Washington, DC. 90 pp.
- Schueler, T., 1987. *Controlling Urban Runoff, A Practical Manual for Planning and Designing Urban BMPs*, July 1987.
- U.S. Environmental Protection Agency, 2002. *Construction Site Storm Water Runoff Control*, National Pollution Discharge Elimination System, [on-line]
http://cfpub.epa.gov/npdes/stormwater/menuofbmps/con_site.cfm
- U.S. Environmental Protection Agency, 1973. *Processes, Procedures, and Methods to Control Pollution Resulting From Construction Activity*. Office of Air and Water Programs, EPA 43079-73-007. October, 1973.
- Urban Drainage and Flood Control District, 1999. *Urban Storm Drainage – Criteria Manual, Vol. 3 – Best Management Practices*, Denver, Colorado, September 1999.
- Washoe County Department of Water Resources, 2002. *Watershed Assessment for Tributaries to the Truckee River, Final Report*, prepared by the Michael Widmer, Washoe County Department of Water Resources and Jeff Jesch, Washoe-Storey Conservation District, July 2002.
- Washoe-Storey Conservation District, 1998. *Steamboat Creek Restoration Plan*. Prepared for Western Nevada RC&D, Washoe-Storey Conservation District, and other cooperating agencies. Prepared by Jeff Codega Planning/Design Inc. and WESTEC, Inc.

Section 3: The Truckee Meadows Construction Site Discharge Program

3.1 Local Program Requirements

The Cities and County are responsible for developing, implementing, and enforcing a program to prevent pollutants from construction activities from entering their municipal storm drain systems. Per Federal regulations (40 CFR § 122.26), the program must include the following elements:

- An ordinance or other regulatory mechanism to require erosion and sediment controls, as well as sanctions to ensure compliance, to the extent allowable under State or local law.
- Requirements for construction site operators to implement appropriate erosion and sediment control BMPs.
- Requirements for construction site operators to control wastes such as discarded building materials, concrete truck washout, chemicals, litter, and sanitary waste at construction sites that may cause adverse impacts to water quality.
- Procedures for site plan review which incorporate consideration of potential water quality impacts.
- Procedures for receipt and consideration of information submitted by the public.
- Procedures for site inspection and enforcement of control measures.

3.2 Legal Authority

The Cities of Reno and Sparks have existing municipal codes and ordinances which grant them the authority to control construction site discharges by requiring the implementation of erosion, sediment and waste control BMPs per the standards presented in this BMP handbook. The ordinances require that construction sites are in compliance with all applicable state and federal NPDES permits. They also allow the Cities to collect an administrative service charge for the inspection of construction sites, and to conduct enforcement actions. For the City of Reno these codes and ordinances are contained in Chapter 18.12.404. of the Reno Municipal Code (Codified through Ord. No. 5466, § 1, 6-25-03). For the City of Sparks they are contained in Chapter 13 of the Sparks Municipal Code (Sections 13.65.010 through 13.65.280).

For Washoe County, erosion control and grading standards for new construction are contained in Section 110.438 of the Development Code. The Washoe County Stream Buffer Ordinance is contained in Article 418 of the Washoe County Development Code. This ordinance regulates development activity within and adjacent to perennial streams by establishing buffer zones. Per Section 110.418.15, perennial stream buffer areas are established to provide adequate setbacks and land use controls to ensure the water quality functions of each perennial stream are not jeopardized through development activity. To limit significant impacts adjacent to

hydrological resources, critical and sensitive stream zone buffer areas have been established and all proposals to develop uses within these buffer areas must submit site plans with the boundaries of the buffer areas accurately defined. Very limited development activities are allowed within the boundary of the “critical stream zone buffer area”, defined as all land and water surface within thirty (30) feet from the centerline of the perennial stream. Allowed activities within the critical stream zone buffer area include approved weed control, mosquito abatement, and conservation practices, outdoor recreation activities and certain approved maintenance and landscaping activities. The sensitive stream zone buffer area is defined as all land and water surface between the critical stream zone buffer area boundary, out to one hundred fifty (150) feet from the centerline of the perennial stream. Allowed activities within the sensitive stream zone buffer area include some detached single family residential uses requiring a building permit issued by the Washoe County Building and Safety Department, landscaping area requirements in accordance with Article 412, and new fencing, constructed in accordance with Washoe County Code. Article 424 also establishes provisions for preserving and protecting hillsides from vegetation loss and erosion during new development.

The Cities and County also have existing ordinances and practices that require permits for construction activities and a regulatory process for reviewing plans, approving permits and inspecting construction sites for compliance. The permits for construction activities include grading, site development, building, and encroachment permits. Plans requiring review include tentative, final, parcel and subdivision maps, site plans, drainage plans, and erosion and sediment control plans. The existing permitting and plan review process differs between the jurisdictions and is based on different governmental structures, ordinances, policies and procedures. Grading, which is the primary land disturbing construction activity, is currently regulated by the three jurisdictions under the ordinances presented on Table 3-1.

Table 3-1: Existing Grading Regulations			
	City of Reno	City of Sparks	Washoe County
Code Sections	Municipal Code 18.06.801 (Grading Permit) 14.03 (Building Permit) 18.06.407 (Site Plan Review)	Municipal Code 15.21.0010 Adoption of IBC (Building Permit); 17.20.020 (Subdivisions); 20.31.030 (Site Plan Review); 20.99.040 (Slopes Hilltops and Ridges); 20.45.090 (Adjacent Lots)	Development Code 110.420 (Storm Drainage Standards) and 110.438 (Grading Standards); County Code 100.100.10 adopted codes (IBC adopted)
Requirements	Grading Plans Grading Permits	Grading Plans Grading Permits	Site and Drainage Plan Grading Permits

Since the regulation of grading and other types of earthwork construction varies between the three jurisdictions, consistent requirements have been added to their ordinances that require construction site operators to implement Best Management Practices (BMPs) to control erosion, and minimize discharges of sediment and wastes. The ordinances require construction sites to properly manage construction materials and wastes so that they cannot be transported by storm water runoff into a water body, channel or storm drain. Implementation of BMPs is required at

all construction sites that disturb a total area of one acre or greater. The BMPs must be implemented according to the performance standards noted in the following section.

The application of uniform ordinance requirements and performance standards, together with the BMP specifications presented in section 6.0 of this handbook, provide the regulatory and technical parameters that must be met to implement construction site discharge control. The policies and procedures of the Cities and County (presented in Section 3.4) are intended to provide the regulatory mechanism necessary to ensure these standards are implemented.

3.3 Performance Standards

The goal of the Best Management Practices (BMPs) presented in this handbook is to conduct all construction activities in a manner that effectively mitigates accelerated soil erosion, sediment movement and sediment deposition offsite and also manages construction materials and wastes to prevent or minimize their potential runoff from the site. The BMPs selected shall meet all of the following standards:

1. Schedule construction activities to minimize the total amount of soil exposed at any given time. Preserve native and adapted desirable vegetation to the maximum extent practicable and conduct clearing and grading only in areas necessary for building activities and equipment traffic.
2. Establish temporary or permanent stabilization practices on areas that have been disturbed as soon as practicable and no later than 14 days after construction activity in that portion of the site has temporarily or permanently ceased. Some exceptions may apply; refer to the 2015 Stormwater General Permit NVR100000, 3.6. (Appendix A).
3. Protect slopes susceptible to erosion by installing controls such as terraces, benches, retaining walls, temporary slope drains, fiber rolls, rolled erosion control products and vegetation.
4. Design and construct all temporary and permanent facilities that convey water around or through disturbed areas with slopes and control measures that limit the flow of water to non-erosive velocities.
5. Protect waterways within and bordering the site by installing vegetative buffers and temporary stream crossings. Protect natural drainages, storm drain channels and storm drain inlets in the vicinity of construction sites from disturbance, sedimentation and deposition of polluting materials such as construction site wastes.
6. Retain sediment caused by accelerated soil erosion from surface water before it leaves the site by installing sediment traps and/or perimeter controls such as temporary diversion dikes silt fences, fiber rolls, gravel berms, berms constructed with salvaged native material, and k-rail. From May through October, water shall not be allowed to pond behind erosion or sediment controls for more than seven days.

7. Remove sediment accumulated in BMPs at regular intervals and as soon as practicable after a storm water runoff event. Sediment must be removed when BMP design capacity has been reduced by 30 percent.
8. Remove sediment accumulated in BMPs prior to the removal of the BMP or at the completion of construction.
9. Control construction site entrances and exits to minimize sediment deposition on roads to the maximum extent practicable.
10. Do not store soil, aggregates, topsoil, compost, construction materials or wastes on paved roadways.
11. Properly store construction site materials and manage wastes to prevent or minimize contact with storm water and transport offsite. Construction site materials include, but are not limited to, petroleum products, paints, adhesives, and solvents. Construction site wastes include, but are not limited to, concrete washout, excess construction materials, empty storage containers, and litter.
12. Properly manage vehicle and equipment fueling, maintenance, storage and parking areas to prevent and control leaks and spills. Properly manage the cleaning of vehicles and equipment to prevent the discharge of wash water and pollutants to the storm drain system, natural drainages or watercourses.
13. Establish permanent stabilization on all bare soils with perennial vegetative cover and/or equivalent permanent stabilization measures upon completion of all site soil disturbing activities. Areas stabilized with vegetative cover must have a minimum of 70 percent of the native background (reference) vegetative cover. Some exceptions may apply - refer to the 2015 Stormwater General Permit NVR100000, 3.6 (See Appendix A).

If the project or site exhibits conditions that make achieving any of the objectives noted above infeasible, the contractor or other responsible party shall note those conditions in the Performance Standards Compliance Checklist (Appendix D) and propose the rationale for eliminating a standard.

3.4 Local Policies and Procedures

The Cities of Reno and Sparks and Washoe County have developed a regional approach to implementing a Construction Site Discharge Program. In addition to this regionally adopted BMP handbook, three procedural documents are used by these jurisdictions to assist their staff with the task of ensuring that BMPs are implemented at construction sites in accordance with the standards and specifications of this BMP handbook. Three checklists are used to address construction permit submittal requirements and plan review practices; performance standards compliance; and inspection, both by contractors and local government inspectors. The checklists developed to address these policies and procedures are the following:

- Construction Permit Submittal Checklist.
- Performance Standards Compliance Checklist.

- Construction Site Inspection Checklist.

Blank copies of these checklists are presented in Appendix D.

These checklists represent the fundamental framework for the Regional Storm Water Quality Management Program. Each jurisdiction is individually responsible for their own ordinances, plan review, permitting, and inspection of construction sites.

3.4.1 Plan Review

The following plan review policies and procedures were developed after consultation with NDEP regarding the required contents of a local program. Additional plan review procedures may be implemented individually by each jurisdiction.

The Construction Permit Submittal Checklist is used by City and County staff to identify projects that will disturb one acre or larger. This includes all projects that may require a grading, site development, building, or encroachment permit (including public works projects). It may also be applied to plans requiring review, including final, parcel, and subdivision maps and site drainage and erosion and sediment control plans. If the applicant indicates the total planned area of land disturbance will be one acre or more on the checklist, then they must submit a copy of their Notice of Intent (NOI) submitted to NDEP and a copy of the letter of authorization from NDEP. If the applicant has not yet received the letter of authorization, a copy of the receipt for payment of the annual fee that is due at the time of filing is also acceptable.

Once the applicant files the NOI and pays the annual fee, they are immediately covered under NDEP's 2015 General Permit. By submitting copies of the NOI, the letter of authorization or the receipt, completing and signing the checklist, the applicant acknowledges that they are aware of NDEP's 2015 General Permit requirements, including the requirement to develop and implement a site specific SWPPP. The applicant further acknowledges that they are aware of this BMP handbook and the required performance standards noted above. A copy of the Performance Standards Compliance Checklist (discussed below) must be attached to the Construction Permit Submittal Checklist. In addition, the permit submittal checklist indicates that applicants must include five Standard Notes on all site plans for projects that disturb one or more acres. These Standard Notes indicate the following:

1. All public right of ways located adjacent to the site (e.g. streets and sidewalks) must be cleaned daily of all sediment or wastes that originate from the site.
2. BMPs in addition to those indicated in the SWPPP may be required if they don't meet local performance standards.
3. **Temporary or permanent stabilization must be applied no later than 14 days to all disturbed soils, including stockpiles, where construction activity has ceased.**
4. All BMPs must be inspected weekly, prior to forecasted rain events, and within 24 hours after any event that creates runoff at the site.

5. Accumulated sediment must be removed from BMPs when the design capacity has been reduced by 30 percent or more. Sediment must also be removed within seven days after a runoff event or prior to the next forecasted rain event whichever is earlier.

Finally, the permit checklist also recommends that applicants submit a copy of their SWPPP. The Cities and/or the County may require a copy of the SWPPP to ensure that one has been completed for the project site. However, the Cities and the County are not responsible for reviewing or approving SWPPPs.

The Performance Standards Compliance Checklist will be submitted with the Construction Permit Submittal Checklist. Permit applicants and those that require plan reviews for proposed construction projects that will disturb one or more acres of land will use the checklist to establish a set of BMPs to meet the applicable performance standards noted in Section 3.3 (above). During the first visit to the site, inspectors will also review the applicant's checklist to ensure that the set of BMPs selected fully meet all of the standards. The checklist indicates that the applicant must select at least one BMP to meet each performance standard. It further indicates that the applicant is responsible for ensuring that the BMPs selected on the checklist are included in the contract bid documents. Finally, the checklist infers that some project sites may have characteristics that make meeting a performance standard infeasible or inapplicable (e.g. no steep slopes or no storm drain inlets at the site). If this occurs, the applicant is required to describe the specific site characteristics that prevent them from meeting a performance standard at the bottom of the form. In order to be effective, this checklist, together with the Construction Permit Submittal Checklist must be completed before permits are granted or plans are approved.

3.4.2 Inspection and Enforcement

Construction site operators are encouraged to use the standard checklist for self-inspections (Appendix D). Weekly, pre-storm and post storm self-inspections are required under the NDEP 2015 General Construction Permit. A reduced inspection schedule may be implemented for sites that meet certain land disturbance activities and stabilization. See section 5.3.1 of the new 2015 Nevada General Permit NVR100000. The Cities and the County also use the checklist to assist staff with a consistent approach at conducting inspections and to ensure that the performance standards discussed above are being met.

The Construction Site Inspection Checklist is intended for use by construction site operators who are required to conduct frequent inspections to ensure that site BMPs are installed and maintained appropriately. Construction site operators, or their qualified agents, must attach completed inspection checklists to their SWPPPs to provide documentation of their self-inspection efforts. Photo documentation of BMP installations and corrective actions is also recommended. The inspection checklist is also intended for use by local government inspectors to ensure that the BMPs identified in the Performance Standards Checklist are actually implemented at the site. With the exception of the first question (has it rained since the last inspection?), if the answer is NO to any of questions on the checklist, the inspector is directed to indicate the corrective action needed and the date it will be completed. This procedure is also required under Section 5 of NDEP's 2015 General Construction Permit (Appendix A).

Enforcement policies and procedures have also been established individually by each jurisdiction as part of their ordinances for Construction Site Discharges. The typical order of enforcement policies and procedures includes the issuance of a notice of violation (NOV), followed by cleanup and abatement orders, fines and/or stop work orders. Problem sites may also be referred to NDEP for further enforcement.

Per NDEP's 2015 General Construction Permit (Appendix A), any permit non-compliance constitutes a violation of the Clean Water Act (CWA) and is grounds for enforcement action, permit termination, revocation and re-issuance, or modification, or denial of a permit renewal application. NRS 445A.675 provides that any person who violates a permit condition is subject to administrative and judicial sanctions as outlined in NRS 445A.690 through 445A.705.

Under section 309 of the CWA, the EPA can issue administrative orders against violators, and seek civil or criminal penalties when necessary. For a first offense of criminal negligence, the minimum fine is \$2,500, with a maximum of \$25,000 fine per day of violation. A violator may also receive up to a year in jail. On a second offense, a maximum fine of \$50,000 per day may be issued. For a knowing endangerment violation (i.e. placing another person in imminent danger of death or serious bodily injury) a fine may be issued up to \$250,000 and/or imprisonment up to 15 years for an individual, or up to \$1,000,000 for an organization.

3.4.3 Public Reporting

The Cities and the County must respond to public reporting of questionable construction activities. Currently the City's Public Works and Environmental Control departments and the County's Community Services and District Health departments receive and respond to complaints. In the future, a centralized "Hotline" may be developed for public reporting of all water quality concerns and complaints. Currently, illegal dumping of unknown substances at construction sites and discharges of non-storm water substances to the storm drain system, other than those noted in Section 2.8, should immediately be reported to the Washoe County District Health Department, Environmental Health Services Division (775) 328-2436, The City of Sparks Environmental Control (775) 691-9227, the City of Reno Environmental Control (775) 334-4636, and NDEP (888) 331-6337.

3.4.4 Public Resources

The Natural Resource Conservation Service (NRCS) is a division of the United States Department of Agriculture and its primary function in Nevada is to provide assistance to agricultural projects. However, the NRCS also provides local soil survey information to contractors and design engineers working on public and private construction projects.

Natural Resource Conservation Service
5301 Longley Lane
Reno, NV 89502
Phone: (775) 784-5317 Fax: (775) 784-5939
Current Contact: Mr. Charles Houston, State Conservation Engineer
Website: <http://www.nrcs.usda.gov/>

The Nevada Division of Environmental Protection (NDEP), Bureau of Water Pollution Control is the state agency responsible for issuing the 2015 General Construction Permit. As such, NDEP can provide assistance to contractors and design engineers with permit requirements, preparing SWPPPs, and selecting the appropriate BMPs at construction sites. The NDEP website also provides a significant amount of information about the state and EPA storm water programs, including digital versions of the 2015 General Construction Permit, the Notice of Intent (NOI), and the Notice of Termination (NOT).

Nevada Division of Environmental Protection
Bureau of Water Pollution Control
901 South Stewart Street, Suite 4001
Carson City, NV 89701
Phone: (775) 687-9429 Fax: (775) 687-4684
Current Contacts: Mr. Cliff Lawson and Mr. Steve McGoff
Email: clawson@ndep.nv.gov and smcgoff@ndep.nv.gov
Website: http://ndep.nv.gov/bwpc/storm_cont03.htm

The Nevada Division of Forestry (NDF) is a state agency and its primary function is to protect, manage and rehabilitate the states forests. BMP assistance is also provided under NRS 528 for construction sites proposing to convert forestlands to non-forest uses. NDF manages the Urban Forestry Program and provides assistance on protecting trees. The agency also manages the Nevada Tree Bank and the Nevada Tree Nursery. NDF has also worked on revegetation projects on the Truckee River with the Nature Conservancy. NDF is familiar, and can provide assistance with, local soils, native vegetation, and effective methods of controlling erosion and sediment transport at construction sites in the Truckee Meadows.

Nevada Division of Forestry
2478 Fairview Drive
Carson City, NV 89701
Phone: (775) 684-2500 Fax: (775) 684-2570
Current Contact: Rich Harvey
Website: <http://www.forestry.nv.gov/>

The Truckee Meadows Water Authority (TMWA) provides local landscape information that can be used to assist contractors, landscape architects and landowners with revegetation and final site stabilization efforts. TMWAs Landscape Information Package includes an 'Irrigation and Design Guide', a 'Plant Guide' and a 'Maintenance and Planting Guide' with recommended hardy water-efficient plants and tips to design and maintain a robust landscape in the arid climate of the Truckee Meadows.

Truckee Meadows Water Authority
1355 Capital Blvd.
Reno, NV 89502
Phone: (775) 834-8000 Fax: (775) 834-8003
Website: <http://www.tmh2o.com>

Wilbur D. May Arboretum and Botanical Gardens/Washoe Regional Parks and Open Space, conducts educational classes on erosion and sediment control, landscaping techniques, home irrigation design, turf alternatives and xeriscape gardening. The Botanic and Demonstration Gardens at the May Arboretum also provide numerous examples of local plants and other species that grow successfully in the Truckee Meadows.

Wilbur D. May Arboretum

Located at Rancho San Rafael Park

1595 N. Sierra Street

Reno, NV 89503

Phone: (775) 785-4153 Fax: (775) 785-4707

Current Contact: Bill Carlos, Horticulturist

Email: Bcarlos@washoecounty.us

Section 4: Storm Water Pollution Prevention Plans

4.1 Who Must Prepare a SWPPP

Since March 10, 2003, the owners/operators of all proposed private and public construction sites that will disturb a total of one or more acres of land are required to obtain coverage under NDEP's 2015 General Construction Permit (Appendix A). A list of the type of projects requiring coverage under the 2015 General Construction Permit is presented in Section 2.7. To obtain permit coverage, the owners and/or operators of all applicable construction sites are required to submit a Notice of Intent (NOI) and an annual fee to NDEP, and develop and implement a SWPPP. The NOI must be filed at least 48 hours before construction begins and the SWPPP must be prepared prior to submittal of the NOI. The SWPPP is not to be submitted to NDEP for review or approval, but must remain on the project site as a living document during the duration of the project. The Cities and the County require certification that a SWPPP has been completed prior to issuing construction permits and/or approving plans for sites that will disturb one or more acres of land. In addition, the *permittee (Defined as the owner and/or operator of the construction site. This is the person that has operational control of the construction plans and specifications, or has day-to-day operational control of the activities necessary to ensure compliance with the SWPPP)* must make the SWPPP available upon request to NDEP or local government officials inspecting the construction site.

Developing a SWPPP requires that a qualified individual or team of individuals be identified as responsible for developing and revising the site's SWPPP. NDEP is adding to the 2014 CGP the requirement to establish a "Stormwater Team" to oversee development and any modifications to the SWPPP, and to ensure compliance with this permit. Stormwater Team is defined in Appendix A as follows:

"Stormwater Team – refers to an individual or group of individuals responsible for oversight of the development and modification of the SWPPP, and oversight of compliance with the permit requirements."

4.2 SWPPP Components

Per NDEP's 2015 General Construction Permit, the SWPPP is to be prepared in accordance with good engineering practices and shall consist of the following components:

- Project information such as the site location, type of project, the name and address of the owner and/or operator, the name and address of a contact person and the person responsible for implementing the plan.
- A copy of the NOI submitted to NDEP.
- A description of all proposed and implemented major land disturbing activities.
- Estimates of the total area of the site and the area that will be disturbed.
- Estimates of pre and post-construction runoff coefficients.

- A general location map and a detailed site map including, but not limited to, site drainage patterns, the steepness of cut slopes, areas of soil disturbance, location of BMPs, borrow and equipment storage areas, areas where final stabilization has been accomplished and no further construction activities will occur, and a legend describing all map symbols used.
- Identification of the receiving waters (streams, rivers, ditches, drainages, lakes, wetlands, etc.) the site will discharge runoff to, either directly or via the municipal storm drain system.
- A demonstration that the selected BMPs will be sufficient to ensure that the discharges from the site will not cause or contribute to an exceedance of an applicable State water quality standard (if the construction site discharges to a water body on Nevada's 303(d) list or a water body with an established Total Maximum Daily Load or TMDL).
- Documentation of all proposed and implemented erosion, sediment and waste control measures (aka BMPs), including a description of the permanent storm water treatment controls that will be built as part of the project to treat post-construction storm water runoff.
- The qualifications of the person(s) selected to inspect the BMPs implemented on site.
- Documentation of all self-inspections, maintenance of BMPs, and corrective actions.
- Location and description of any non-storm water discharges and storm water discharges from dedicated asphalt and concrete plants located off-site.
- Certification by the owner/operator or authorized representative and all contractors who work on the construction site.
- A copy of the General Construction Permit.

With the exception of the NOI and the 2015 General Construction Permit, each of the above elements must be revised as necessary to maintain accuracy if there are changes in design or construction of the project or the SWPPP is found to be insufficient.

4.3 Regional Program SWPPP

Appendix C provides a blank copy of the model SWPPP template that is preferred for use in the Truckee Meadows (hereinafter referred to as the Regional Program SWPPP). A digital version of the Regional Program SWPPP can be accessed at www.TMstormwater.com. The format of the Regional Program SWPPP follows the order of the required elements presented in NDEP's 2015 General Construction Permit (Appendix A). Permit section numbers follow the text in each section of the Regional Program SWPPP for ease in cross-referencing. The digital version of the Regional Program SWPPP includes expandable user response dialog boxes. If additional the existing space in the user response boxes of the Regional Program SWPPP presented in Appendix C is insufficient to provide the required information, pages can be copied and added or other sheets can be inserted and their pages numbered. Consistent use of the Regional Program SWPPP will promote plan consistency, increase the quality and completeness of SWPPPs, and assist the Cities, the County and NDEP with inspections.

4.4 Pre-Construction Site Assessment

Prior to commencing construction activities at a site, it is highly recommended that a site assessment be conducted to document the following existing conditions:

- Vegetation types and cover.
- Salvageable materials (vegetation, organic matter, gravel, rock).
- Landforms, slopes, and soil types.
- Drainages, waterways and storm drain systems.
- Existing structures, roadways, and disturbed areas.
- Wind direction.
- Historical soil and water quality data and land use information.

Section 3.6 of NDEP's 2015 General Construction Permit indicates that data describing soil and the quality of any discharges from the site shall be included in the SWPPP. In addition to this requirement, documentation of existing conditions can provide important baseline information that can be used to help develop the SWPPP, properly select BMPs, and establish final stabilization. General site soils information can be obtained from the NRCS (see Section 3.4.4 of this handbook). The data collected from site or neighboring geotechnical investigations can also provide useful information. Photo documentation of existing vegetative cover can be very useful when attempting to establish final stabilization. NDEP's 2015 General Construction Permit requires that a permanent perennial vegetative cover be established on all disturbed soils with a density equivalent to 70% of the pre-construction existing vegetative cover. Equivalent non-vegetative permanent stabilization measures can also be implemented. Final site stabilization is required prior to NDEP's issuance of a Notice of Termination (NOT). Once the owner/operator of the construction site receives an NOT, they are no longer responsible for any discharges that may occur at the site.

4.5 Detailed Site Map

In addition to a general location map that identifies the site relative to existing streets, highways, and landmarks. Section 6.2.6 of the 2015 General Construction Permit requires the submittal of a detailed site map. The site map shall be updated and revised as site conditions change, new BMPs are implemented, and areas are stabilized. It shall be drawn to scale, include a north arrow, and identify the following features located within and near the permitted project boundaries:

- Existing and proposed topography, including drainage patterns and slopes anticipated after major grading.
- Locations of construction activities and soil disturbance.

- Locations of areas that will not be disturbed.
- Location of salvageable materials.
- Location of state-listed Noxious Weeds.
(http://agri.nv.gov/Plant/Noxious_Weeds/Noxious_Weeds_Home/)
- Locations of onsite and offsite soil borrow and stockpile areas.
- Locations of major structural and non-structural BMPs identified in the SWPPP.
- Locations of areas where soil stabilization practices will be applied.
- Locations where vehicles and equipment will be maintained, fueled, or stored.
- Locations where construction materials, supplies and wastes will be stored, including designated concrete washout areas.
- Locations, names and aerial extent of all surface waters, including streams, ponds, wetlands, or other special aquatic sites at or near the site which will be disturbed or which will receive discharges from disturbed areas of the project.
- Locations where storm water discharges will enter surface waters, the municipal storm drain system, and/or ephemeral waters or dry washes at or near the site.
- Location and description of any discharge associated with industrial activity other than construction, including storm water discharges from dedicated asphalt or concrete plants.
- Areas where final stabilization has been accomplished and no further construction-phase permit requirements apply.
- A legend describing all symbols, BMP numbers and abbreviations used on the map.

The location and type of BMPs that are proposed, and those actually implemented on the site, shall be identified on the site map using the map symbols provided in Section 5.2 of this handbook. As with the entire SWPPP, the site map shall be considered a living document that must be revised and updated when project design conditions change and BMPs are installed, moved, changed or removed.

4.6 Consistency with Other Regulations, Permits and Plans

Per section 6.1.2.4 of NDEP's 2015 General Construction Permit, the SWPPP must be consistent with all applicable State, and/or local waste disposal, sanitary sewer or septic system regulations, 303(d) listings and TMDL requirements (discussed in the next section), and all sediment and erosion site plans, storm water management plans and site permits approved by State or local officials. The SWPPP must be updated as necessary to remain consistent with any changes applicable to protecting surface water resources in other sediment and erosion site plans or site permits, or storm water management site plans or site permits. In addition, the SWPPP may incorporate by reference the appropriate elements of plans required by other

agencies. A copy of the requirements incorporated by reference shall be included as an attachment to the SWPPP.

4.7 303(d) Listed Pollutants of Concern and TMDLs

Per section 1.4.4 of the 2015 General Construction Permit (Appendix A), permittees must determine if their proposed construction sites will discharge (either directly or indirectly) to a 303(d) listed water body or a water body with an established Total Maximum Daily Load (TMDL). If the site may eventually discharge to a water body on the current Nevada 303(d) List, the SWPPP must include a narrative demonstration that the BMPs that are selected will be sufficient to ensure that the discharges will not cause or contribute to an exceedance of an applicable State water quality standard.

1.4.4.1 That the site will employ measures to prevent the discharge of stormwater pollutant(s) for which the waterbody is impaired; or

1.4.4.2 That the discharge from the site has no potential to contain the pollutants causing impairment; or

1.4.4.3 That the discharge is not expected to cause or contribute to an exceedance of an applicable water quality standard.

The Permittee shall comply with all applicable TMDL requirements. TMDL information can be found on the NDEP website: <http://ndep.nv.gov/bwqp/303dlist2012.htm>

To determine if a site may eventually discharge to a water body on the current Nevada 303(d) List, the permittee must identify the water body nearest to the site that may receive storm water runoff from the site. Perennial streams in the Truckee Meadows can be identified using either topographic maps developed by the United States Geological Survey (USGS) or using the City of Reno's Watershed MapServer (<http://maps.cityofreno.net/watershed/>) or NDEP's Integrated Report Web Map Application (<http://ndep.nv.gov/bwqp/gis/webmap2010.htm>). Once the nearest receiving water body is identified, the permittee must describe the routing of discharges from the site to the final receiving water body (e.g. the Truckee River, Swan Lake Playa, etc.). The permittee must then check the current EPA Approved Final Nevada's 303(d) List of Impaired Water Bodies (<http://ndep.nv.gov/bwqp/standard.htm>) for the Truckee River Hydrographic Basin and indicate in the SWPPP whether storm water drainage from the site will eventually discharge to a 303(d) listed water body or a water body with an established TMDL. As of the writing of this BMP Handbook update, the current 303(d) List of Impaired Water Bodies can be found in Nevada's 2008-10 Water Quality Integrated Report (with EPA overlisting), May 2013. It should be noted that the Nevada 303(d) List is updated and submitted to EPA for approval every two years and NDEP is currently in the process of preparing the 2014 Integrated Report. When approved, this list will become the current list. If the site may eventually discharge to one or more listed water bodies, the SWPPP must describe the condition for which each water body has been listed.

An example of an indirect discharge that eventually discharges to more than one listed water bodies would be a site with storm water drainage that discharges first to an underground storm drain pipe system that then discharges to a dry ephemeral wash that is tributary to Thomas

Creek. Thomas Creek is tributary to Steamboat Creek, which is tributary to the Truckee River and all three water bodies are listed on the current Nevada 303(d) List.

As noted on the EPA Approved Final Nevada's 2008-10 303(d) List of Impaired Water Bodies, Upper Thomas Creek is listed for Zinc (Zn) and lower Thomas Creek for Arsenic (As) and Boron (B) and the section of Steamboat Creek at and below the confluence with Thomas Creek is listed as impaired for As, B, Iron (Fe) and Zinc (Zn).

In addition, the Truckee River at and below the confluence with Steamboat Creek has established TMDLs for total nitrogen (TN), total phosphorous (TP) and total dissolved solids (TDS). Therefore, in this example, the SWPPP must discuss the routing of the drainage from the site and indicate the 303(d) listed pollutants of concern and TMDLs for each water body that may eventually receive discharges from the site. Since many areas of the Truckee Meadows eventually drain to the Truckee River (such as the site noted in the example noted above), it may be appropriate to list the Truckee River as the ultimate receiving water body and also list the 303(d) listed pollutants of concern and TMDLs for the potentially affected reach of the Truckee River and all the tributaries which may convey runoff from the site to the affected reach of the river.

To address the requirements to assess whether discharges from a construction site will contribute significantly to any applicable 303(d) listing or a TMDL, and whether the BMPs implemented at the site will be adequate to ensure that discharges from the site will not cause or contribute to an exceedance of State water quality standards (2015 General Construction Permit, Section 3.9.), the NDEP has advised the Cities and the County that when properly installed and maintained, the conventional erosion and sediment control BMPs presented in this handbook will be assumed to be sufficient to meet this permit requirement. No monitoring of construction site discharges is currently required.

4.8 Selecting Construction Site BMPs

The following are the recommended guidelines for selecting erosion and sediment control BMPs during the development of a SWPPP. The BMPs identified by alphanumeric codes below are summarized in Section 5.1 and discussed in detail in Sections 6 through 11 of this handbook.

14. Define the limits of clearing and grading activities. Determine if below grade construction, buffer strips or natural vegetation (PL-1) can be utilized as a control measure.
15. Define the layout of proposed buildings and roads. Define opportunities for staging or sequencing construction activities to minimize the amount and period of exposure of disturbed soils. Determine if existing vegetation can be preserved (EC-1) and scheduling (PL-2) and/or phased construction (PL-3) can be incorporated into the project.
16. Determine permanent drainage features such as channels, storm drains, and roadside swales. Determine if these existing or proposed features provide permanent diversions (RC-1) that prevent runoff from adjacent areas from entering the project site.

17. Determine drainageway protection BMPs (Section 10). Determine the BMPs that will be used to protect from erosion the permanent drainage features determined in #3 as well as all other receiving waters.
18. Determine storm water quality controls. Determine if existing or proposed storm water quality controls such as detention basins, ponds, wetlands, grass-lined swales, buffer strips and areas of porous pavement can be used to treat runoff from the site.
19. Determine the location and extent of temporary diversion dikes and ditches (RC-2). Determine if these BMPs can be used to minimize storm water runoff onto disturbed soil surfaces.
20. Determine the boundaries of the watersheds that could potentially contribute runoff to the site. The size of the drainage basins will determine the types of sediment controls to be used.
21. Select sediment controls. For drainage areas of 10 or more acres, NDEP requires the use of sediment retention basins (SC-7). Drainage areas smaller than 10 acres may utilize sediment retention basins other sediment controls (Section 9). The maximum drainage area for a temporary sediment retention basin is 20 acres.
22. Identify locations for salvaged native materials and fill stockpiles. Define the stockpile management BMPs (GM-2) that will be used to minimize sediment transport from stockpiles during storm events. Consider revegetation of stockpiles depending on material and duration of storage.
23. Identify the location of temporary construction roads, entrances and exits. Determine the vehicle tracking controls (SC-8, SC-9 and SC-10) that will be used to minimize the tracking of sediments offsite onto paved roadways.
24. Identify the location of equipment and material storage areas, and waste storage areas. Determine the General Site and Materials Management BMPs (Section 11) that will be used to minimize spills, contain wastes and prevent their contact with storm water.
25. Select erosion controls (Section 8). All exposed soils that will not be re-disturbed or covered with a structure will require control measures that will be based on the duration of exposure and the schedule of construction activities.

4.9 Inspection and Maintenance

Construction site operators or their qualified agents shall use the Construction Site Inspection Checklist discussed in Section 3.4.2 and presented in Appendix D for site inspections. Section 5 of NDEP's 2015 General Construction Permit indicates that construction site inspections shall occur by qualified personnel at least once every seven days and within 24 hours of a storm event of 0.5 inches or greater, unless they meet the specified requirements for reduced inspections under section 5.3.1 of the new 2015 Nevada General Permit for Construction NVR100000. Since storms in the Truckee Meadows often produce an uneven spatial distribution of precipitation, it can be difficult to determine actual precipitation totals at specific

locations such as construction sites. Therefore, the Cities and the County require inspections be conducted within 24 hours of any rain event that creates runoff at the site. In addition, inspections shall also occur prior to forecast rain events to ensure that BMPs are in place and functioning properly. In certain circumstances, a pre-storm inspection may also qualify as a routine weekly inspection. Areas that require inspection include the following:

- Disturbed areas that have not attained final stabilization.
- Material and equipment storage areas that are exposed to precipitation.
- All erosion and sediment control measures installed at the site and downstream of the site.
- All structural control measures.
- All locations where vehicles enter and/or exit the site.

If land disturbing activities have been suspended and frozen ground conditions are present, permittees may request a waiver of weekly inspection requirements from NDEP until one month before thawing conditions and runoff are expected to occur.

BMPs shall be inspected at regular intervals to ensure they are installed and maintained appropriately. Construction site operators, or their qualified agents, shall attach completed inspection checklists to their SWPPPs to provide documentation of their self-inspection efforts. Photo documentation of BMP installations and corrective actions is also recommended.

4.10 Potential Enforcement Actions

As noted in Section 3.4.2, the NDEP and the EPA have significant enforcement authority for any permit non-compliance that constitutes a violation of the Clean Water Act (CWA). Potential enforcement actions include permit termination, issuance of stop work orders, and fines. Third party lawsuits can also be filed under the citizen suit provisions of the CWA.

The Cities and the County established enforcement policies and procedures as part of their construction site discharge control ordinances and associated inspection programs. City and County inspectors have the authority to enter construction sites and issue Notices Of Violation (NOVs) and/or pursue additional enforcement actions for sites that lack appropriate BMPs, fail to properly maintain existing BMPs, or allow sediment laden storm water or non-permissible non-storm water to discharge to the municipal storm drain system (see Section 2.8 for permissible non-storm water discharges). Enforcement actions for storm water discharges may also occur at sites with insufficient BMPs to control and treat runoff from the 2-year, 24-hour storm event. A re-inspection fee may be billed to the owner if sites require further compliance inspections or sampling.

4.11 Records Retention

The SWPPP and all records and data produced to comply with the NDEP 2015 General Construction Permit must be retained by the owner/operator for a minimum of three years after

issuance of a Notice of Termination (NOT). NDEP may require a longer period of records retention for some sites.

4.12 References and Websites

U.S. Environmental Protection Agency, 1992. *Storm Water Management for Construction Activities, Developing Pollution Prevention Plans and Best Management Practices, Summary Guidance*, Office of Water, EPA 833-R-92-001, October 1992.

U.S. Environmental Protection Agency NPDES Storm Water Program
http://cfpub1.epa.gov/npdes/home.cfm?program_id=6

Nevada Division of Environmental Protection, Bureau of Water Pollution Control

The NDEP Construction Site webpage (http://ndep.nv.gov/bwpc/storm_cont03.htm) provides links to the following:

- Information regarding the NDEP's filing fees.
- NDEP's Notice of Intent (NOI) – Online Form.
- NDEP's Notice of Termination (NOT).
- NDEP's 2015 General Construction Permit.
- NDEP's Construction Fact Sheet.
- A list of other States Soil Erosion & Sediment Control Manuals for Contractors prepared by the Associated General Contractors of America.
- NDEP's Construction Site BMP Fact Sheets (September 1992).
- The State of Nevada, State Conservation Commission, Best Management Practices Handbook (1994 revision).
- Federal Storm Water Program, Frequently Asked Questions.
- Example Site Map.
- Model SWPPP Template.

External website links are also provided to EPA's Storm Water Program, the Clark County Storm Water Quality Management Committee, and the Truckee Meadows Regional Storm Water Quality Management Program.

Section 5: Best Management Practices

5.1 Approved Construction Site BMPs for the Truckee Meadows

Table 5-1 presents the preferred list of Best Management Practices (BMPs) approved for use at construction sites in the Truckee Meadows. As noted previously in Section 2.6, BMPs are required to reduce or prevent erosion and to control the sediment and wastes that are generated from construction site activities. Construction site BMPs can be temporary measures that are only applied and effective during active construction, and/or permanent measures that work to control erosion and sedimentation and improve storm water quality during and after construction. Temporary and/or permanent construction site BMPs are noted on Table 5-1.

The list presented in Table 5-1 was developed based on a comprehensive review of the Construction Site BMP Manuals developed and used by the following other communities and agencies:

- The California Regional Water Quality Control Board, San Francisco Bay Region.
- The City of Boise, Idaho.
- The City of Sacramento, California.
- Maricopa County, Arizona.
- The State of California Department of Transportation (Caltrans).
- The Urban Drainage and Flood Control District, Denver, Colorado.
- The Nevada Department of Transportation.
- The USEPA National Menu of Storm Water BMPs.
<http://cfpub1.epa.gov/npdes/stormwater/menuofbmps/index.cfm>

Several relevant local documents were also reviewed:

- Erosion Control for Construction Sites, produced by the Washoe-Storey Conservation District, 1997.
- The Draft Construction Activities BMP Handbook prepared for Washoe County, the Cities of Reno and Sparks and the Nevada Department of Transportation, 1994.
- The Drainage Design Manuals currently used by the Cities and County.
- The Handbook of Best Management Practices, produced by the Nevada Division of Environmental Protection and the Nevada Division of Conservation Districts, 1994.

In addition, several independent field manuals, guidance documents and websites were also reviewed and the pertinent information was incorporated in this BMP handbook. All of the documents and websites reviewed during the development of this BMP handbook are listed in Section 5.5.

Table 5-1: Approved Best Management Practices for Construction Sites

Category	BMP#	BMP Name	Temporary	Permanent
Planning	PL-1	Site Design	T	P
	PL-2	Scheduling	T	
	PL-3	Phased Construction	T	
	PL-4	Native Material Reuse	T	P
	PL-5	Employee Training	T	P
Runoff Control	RC-1	Permanent Diversions		P
	RC-2	Temporary Diversion Dikes and Ditches	T	
	RC-3	Check Dams	T	
	RC-4	Temporary Slope Drains	T	
Erosion and Sediment Control	EC-1	Preserving Existing Vegetation	T	P
	EC-2	Slope Terracing and Tracking	T	P
	EC-3	Mulching	T	P
	EC-4	Soil Binders	T	P
	EC-5	Wind Erosion and Dust Control	T	P
	EC-6	Rolled Erosion Control Products	T	P
	EC-7	Riprap*	T	P
	EC-8	Revegetation	T	P
	SC-1	Fiber Rolls	T	P
	SC-2	Brush and Rock Filters	T	P
	SC-3	Sand Bag Barriers	T	
	SC-4	Gravel Filter Berm	T	
	SC-5	Silt Fences	T	
	SC-6	Temporary Sediment Traps	T	
	SC-7	Sediment Retention Basins	T	P
	SC-8	Construction Site Entrances and Exits	T	
	SC-9	Construction Exit Tire Wash	T	
	SC-10	Stabilized Construction Roadway	T	
	SC-11	Synthetic Sediment Control Rolls	T	
SC-12	Compost Filter Berms and Socks	T	P	
Drainageway Protection	DP-1	Temporary Stream Crossing	T	
	DP-2	Storm Drain Outlet Protection		P
	DP-3	Storm Drain Inlet Protection	T	
	DP-4	Catch Basin Inlet Filters	T	

* Riprap is not allowed for use as an erosion or sediment control measure on disturbed slopes within the City of Sparks' residential area construction sites.



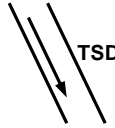





Table 5-1: Approved Best Management Practices for Construction Sites







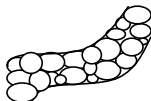

Category	BMP#	BMP Name	Temporary	Permanent
General Site and Materials Management	GM-1	Water Conservation Practices	T	P
	GM-2	Stockpile Management	T	
	GM-3	Solid and Demolition Waste Management	T	
	GM-4	Dewatering Operations	T	
	GM-5	Street Sweeping	T	
	GM-6	Spill Prevention and Control	T	
	GM-7	Vehicle and Equipment Cleaning	T	
	GM-8	Vehicle and Equipment Maintenance and Fueling	T	
	GM-9	Handling and Disposal of Concrete and Cement	T	
	GM-10	Material Delivery, Handling, Storage and Use	T	
	GM-11	Paints and Liquid Materials	T	
	GM-12	Pavement Construction Management	T	
	GM-13	Liquid Waste Management	T	
	GM-14	Sanitary/Septic Waste Management	T	
	GM-15	Landscaping and Revegetation Management	T	P
	GM-16	Contaminated Soil and Water Management	T	
	GM-17	Hazardous Waste Management	T	
	GM-18	Illicit Discharges and Connections – Detection and Reporting	T	
	GM-19	Drilling and Pile Driving Operations	T	
	GM-20	Material and Equipment Use Over Water	T	
	GM-21	Structure Demolition/Removal Over or Adjacent to Water	T	P
	GM-22	Temporary Batch Plants	T	



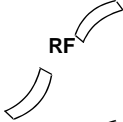
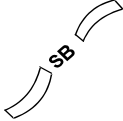

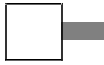
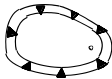

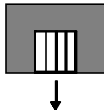

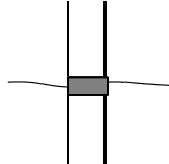

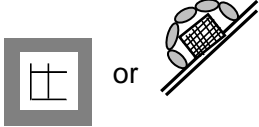
5.2 SWPPP Site Map Symbols



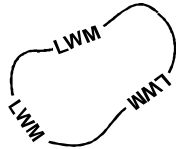







Table 5-2 presents the alphanumeric codes (BMP#, Table 5-1) and map symbols that should be consistently used on SWPPP site maps other construction plans that depict erosion, sediment and waste control BMPs. Use of these simple codes and/or symbols is intended to provide a universally convenient method for depicting BMPs on site plans and other construction plans.

**Table 5-2: SWPPP
Site Map Symbols**

<u>BMP NAME</u>	<u>BMP NUMBER</u>	<u>MAP SYMBOL</u>
Temporary Diversion Dikes and Ditches	RC-2	
Check Dams	RC-3	
Temporary Slope Drains	RC-4	
Preserving Existing Vegetation	EC-1	
Slope Terracing and Tracking	EC-2	
Mulching	EC-3	
Soil Binders	EC-4	
Wind Erosion and Dust Control	EC-5	
Rolled Erosion Control Products	EC-6	
Riprap	EC-7	

<u>BMP NAME</u>	<u>BMP NUMBER</u>	<u>MAP SYMBOL</u>
Revegetation	EC-8	
Fiber Rolls	SC-1	
Brush and Rock Filters	SC-2	
Sand Bag Barriers	SC-3	
Gravel Filter Berm	SC-4	
Silt Fences	SC-5	
Temporary Sediment Traps	SC-6	
Sediment Retention Basins	SC-7	
Construction Site Entrances and Exits	SC-8	
Construction Exit Tire Wash	SC-9	
Stabilized Construction Roadway	SC-10	
Temporary Stream Crossing	DP-1	

<u>BMP NAME</u>	<u>BMP NUMBER</u>	<u>MAP SYMBOL</u>
Storm Drain Outlet Protection	DP-2	
Storm Drain Inlet Protection	DP-3	
Stockpile Management	GM-2	
Solid and Demolition Waste Management	GM-3	
Dewatering Operations	GM-4	
Street Sweeping	GM-5	
Spill Prevention and Control	GM-6	
Vehicle and Equipment Cleaning	GM-7	
Vehicle and Equipment Maintenance and Fueling	GM-8	
Handling and Disposal of Concrete and Cement	GM-9	
Material Delivery, Handling, Storage and Use	GM-10	

<u>BMP NAME</u>	<u>BMP NUMBER</u>	<u>MAP SYMBOL</u>
Paints and Liquid Materials	GM-11	
Pavement Construction Management	GM-12	
Liquid Waste Management	GM-13	
Sanitary/Septic Waste Management	GM-14	
Contaminated Soil and Water Management	GM-16	
Hazardous Waste Management	GM-17	
Illicit Discharges and Connections Detection and Reporting	GM-18	
Drilling and Pile Driving Operations	GM-19	
Material and Equipment Use Over Water	GM-20	
Structure Demolition Over Water	GM-21	
Temporary Batch Plants	GM-22	

5.3 Straw Bale Barriers

Based on literature reviews and the concerns of the District Health Department, straw bale barriers shall not be used for sediment control at construction sites in the Truckee Meadows. Use of straw bale barriers was one of the most common and familiar methods historically used to retain sediment on construction sites, despite the fact that they are relatively ineffective for the following reasons:

- Improper installation and application of straw bale barriers can result in accelerated erosion and sediment transport.
- Straw bale barriers are also maintenance intensive.
- Straw bales shall never be installed in a channel or drainage that conveys concentrated flows or used for storm drain inlet protection. When used in channels and drainages, runoff is often diverted around straw bales creating additional erosion.
- Field manuals and BMP handbooks used by other communities typically indicate that straw bale barriers may only be used as temporary sediment control measures for small runoff events and they can only be used for short periods of time (three months or less). However, straw bales are often misused and remain onsite for extended periods of time, falling apart and becoming an additional pollutant.
- Although “weed free straw” is typically specified, they can also inadvertently introduce noxious weeds to a site if they have not been certified by the Nevada department of Agriculture. In addition, the Washoe County District Health Department has requested that straw bales not be used in the Truckee Meadows because the straw provides a nutrient medium for mosquito breeding. Other communities, such as Sacramento County, have removed straw bale barriers from their list of preferred BMPs and are actively discouraging their continued use.

If straw bales are to be used to temporarily contain concrete washout or to filter muddy water removed from a sediment basin, they must be removed from the site and properly disposed of as soon as their intended function is complete (e.g. the concrete washout is full or dewatering procedures are complete).

5.4 Sizing Criteria for Sediment Retention Basins

Per section 4.2 of NDEP’s 2015 General Construction Permit, If sediment basins are installed the operator shall comply with the following design and maintenance requirements:

- 4.2.1.1 Provide storage for either the calculated volume of runoff from a 2-year, 24-hour storm event for each disturbed acre drained, or 3600 cubic feet per acre drained;
- 4.2.1.2 When discharging from the sediment basin, utilize outlet structures that withdraw water from the surface in order to minimize the discharge of pollutants, unless infeasible. If it is determined to be infeasible, support documentation shall be provided in the SWPPP.

- 4.2.1.3 Prevent erosion of (1) the sediment basin using stabilization controls (e.g., rip-rap or erosion control blankets), and (2) the inlet and outlet using erosion controls and velocity dissipation devices;
- 4.2.1.4 Sediment basins shall be situated outside of surface waters and any natural buffers established under Part 3.5.1; and
- 4.2.1.5 Basins shall be maintained in effective operating condition and removal of accumulated sediment shall be conducted when design capacity has been reduced by 50%.

The drainage policy for new developments in the Cities of Reno and Sparks and Washoe County is to require permanent minimum detention storage for the 5-year, 24-hour storm (for drainage areas less than 20 acres). Permanent local major and regional detention facilities are required to follow the existing design criteria outlined in the Cities and County's drainage design manuals. In addition, the current Truckee Meadows MS4 permit states that flood management projects must also assess the impacts on the water quality of receiving water bodies and evaluate existing structural flood control devices (such as detention and retention basins) to determine if it is feasible to retrofitting the devices to provide additional storm water pollutant removal capability. Sizing, design, construction, inspection and maintenance criteria for permanent sedimentation basins is presented in the current version of the Truckee Meadows Structural Controls Design & LID Manual.

5.5 References and Additional Resource Information

The references listed below provide additional resource information about Federal, State and local programs and regulations, studies of the effectiveness of BMPs, manufactures of erosion and sediment control BMPs, and general information about storm water quality management.

Bay Area Stormwater Management Agencies Association, undated. *Start at the Source – Residential Site Planning & Design Guidance Manual for Stormwater Quality Protection*.

California Regional Water Quality Control Board, San Francisco Bay Area Region, 1999. *Erosion and Sediment Control Field Manual*, 3rd Edition, July 1999.

Caltrans, 2000. *Construction Site Best Management Practices (BMPs) Manual*. State of California, Department of Transportation, November 2000.

Camp, Dresser & McKee, Larry Walker & Associates, Uribe and Associates and Resource Planning Associates, 1993. *California Storm Water Best Management Practices Handbooks – Construction Handbook*, prepared for the Stormwater Quality Task Force.

Camp, Dresser & McKee, Inc. 1993. *Drainage Design Manual for Maricopa, Arizona, Volume III, Erosion Control*. Prepared for the Flood Control District of Maricopa County.

City of Boise, 2002. *Construction Site Control, Responsible Person Training Curriculum*. Boise Planning & Development Services.

City of Boise, 2002. *Erosion & Sediment Control Field Manual, First Edition, March 2002*. Boise Planning & Development Services.

City of Reno, 1992. *Public Works Design Manual*. Department of Public Works, Engineering Division.

City of Sacramento, 1994. *Administrative and Technical Procedures for Grading and Erosion and Sediment Control*. Prepared by the City of Sacramento Department of Utilities, Stormwater Management Program, January 1994.

City of Sparks. 1998. *Hydrologic Criteria and Drainage Design Manual, Draft*.

Denver, Colorado, City and County of, 2000. *Stormwater Quality Control Plans – An Information Guide*, Wastewater Management Division, Department of Public Works, Rev. 5, January 11, 2000.

Fifield, Jerald S., Ph.D., CPESC, 2001. *Designing for Effective Sediment and Erosion Control on Construction Sites*. Forester Press, Santa Barbara, California.

Fifield, Jerald S., Ph.D., CPESC, 2001. *Field Manual on Sediment and Erosion Control, Best Management Practices for Contractors and Inspectors*. Forester Press, Santa Barbara, California.

International Erosion Control Association, 2001. *Workbook: How to Select, Install and Inspect Construction Site Erosion and Sediment Control BMPs for NPDES Storm Water Permit Compliance*.

Kennedy/Jenks Consultants, 1994. *Construction Activities Best Management Practice Handbook*, prepared for Washoe County Department of Comprehensive Planning, City of Reno Community Development Department, City of Sparks Department of Public Works, and Nevada Department of Transportation.

Maricopa County Flood Control District, Arizona, 1993. *Drainage Design Manual for Maricopa County, Volume III, Erosion Control*.

State of Nevada, 1994. *Handbook of Best Management Practices*. Prepared by the Nevada Division of Environmental Protection and the Nevada Division of Conservation Districts.

Urban Drainage and Flood Control District, 1999. *Urban Storm Drainage – Criteria Manual, Vol. 3 – Best Management Practices*, Denver, Colorado, September 1999.

Washoe County. 1996. *Hydrologic Criteria and Drainage Design Manual, Draft*.

Washoe-Storey Conservation District, 1997. *Erosion Control for Construction Sites*.

5.5.1 Websites

Association of General Contractors, Environmental Services
http://www.agc.org/environmental_info/index.asp

Caltrans, Division of Construction <http://www.dot.ca.gov/hq/construc/stormwater.html>

Center for Watershed Protection, Erosion and Sediment Control
http://www.cwp.org/esc_practices.htm

Earths 911, provides information on local recycling centers for hazardous wastes and other construction materials and wastes, <http://www.earth911.org/>

Erosion Control Technology Council <http://www.ectc.org/>

International Erosion Control Association <http://www.ieca.org/>

Nevada Division of Environmental Protection, Bureau of Water Pollution Control, Storm Water Resource Information for Construction Activities <http://ndep.nv.gov/bwpc/storm03.htm>

The Stormwater Managers Resource Center (click on Facts Sheets then ESC)
<http://www.stormwatercenter.net/>

The Truckee Meadows Storm Water Quality Management Program www.TMstormwater.com

U.S. Environmental Protection Agency, 2002. National Pollution Discharge Elimination System Construction Site Storm Water Runoff Control
http://cfpub.epa.gov/npdes/stormwater/menuofbmps/con_site.cfm/

Section 6: Planning Best Management Practices

This section presents the planning concepts that can be incorporated into construction sites to provide temporary and permanent erosion and sediment controls as well as long-term water quality benefits. Detailed information about site design concepts such as low impact development (LID) and structural controls are provided in the Truckee Meadows Structural Controls Design and LID Manual.

Table 6-1: Planning Best Management Practices

BMP#	BMP Name	Temporary	Permanent
PL-1	Site Design	T	P
PL-2	Scheduling	T	
PL-3	Phased Construction	T	
PL-4	Native Material Salvage, Storage, and Reuse	T	P
PL-5	Employee Training	T	P

Site Design

PL-1

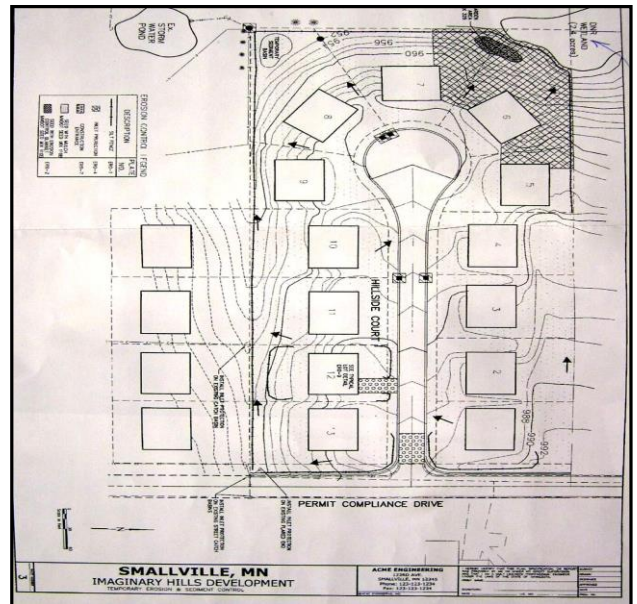
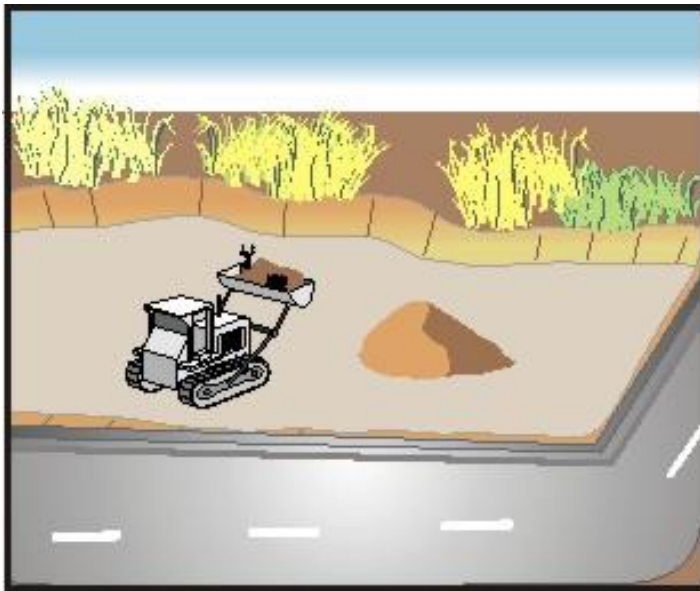

Graphic produced by Kennedy/Jenks Consultants

Purpose: To plan and implement design features that help to minimize the need for erosion and sediment control BMPs and also reduce offsite storm water discharges. Some of these design features can also be used to reduce the rate, volume and pollutant loading of storm water runoff during construction, as well as provide permanent post-construction treatment control.

Applications:

- All construction projects. Examples include vegetated swales installed and established prior to the commencement of major construction activities and use of existing topographic features, natural vegetated buffers and existing structures that prevent, reduce or filter storm water run-on or runoff. Also consider alternative grading techniques such as Landform Grading or Contour Grading.

Limitations:

- Site constraints may limit the ability to use existing vegetation as a filter strip.
- Grass lined swales are difficult to establish in the Truckee Meadows unless they have a permanent irrigation system or are supported hydrology (shallow depth to groundwater or active channel).

Standards and Specifications:

- Limit the amount of continuously connected disturbed soil areas.

- Where possible, preserve existing vegetation and areas with permeable soils that can be used for infiltration of storm water during and after construction is complete.
- Where possible, provide active construction areas with base grade elevations below the elevation of the surrounding area. An active construction area located below the grade of surrounding pavement or sidewalks may be considered to have effective perimeter controls since the entire work area would effectively function as a detention basin during storm events. An example is provided in the graphic above where below grade construction activities and existing curb and gutter result in effective perimeter control.
- Provide additional perimeter control using vegetated swales and filter strips in conjunction with other sediment control BMPs such as fiber rolls, silt fences, gravel berms, and berms constructed of salvaged native material. Vegetated swales and filter strips can also provide permanent post construction structural treatment controls and can consist of preserved or enhanced existing vegetation.
- Limit flow velocities and trap sediments using vegetated swales. If these features are located downstream of the site and are constructed prior to the majority of other construction activities, they can also provide permanent post construction structural controls.
- Refer to the latest version of the Truckee Meadows Structural Controls Design & LID Manual for the design standards of vegetated swales, buffer strips and other structural controls and LID practices.

Inspection and Maintenance:

- Inspect site design features weekly during construction activities that are intended to block or filter storm water runoff to ensure they are adequate to prevent sediment transport offsite. If they are not, install additional BMPs.

Scheduling

PL-2

JANUARY				
MONDAY	TUESDAY	WEDNESDAY	THURSDAY	FRIDAY
		1	2 NTP MOBILIZATION	3
			8 Land clearing	9
6 Install erosion & sediment control measures	7			10 Grading
				15
				16
				22
				23

Graphics used with permission of Caltrans

Purpose: To encourage the sequencing of construction activities and minimize the exposure of un-stabilized soils to erosion by wind, rain, and runoff.

Applications:

- All locations that include grading or earthwork.

Limitations:

- Certain activities such as permanent revegetation (seeding) are constrained by climate and should be conducted within seeding windows.

Standards and Specifications:

- Incorporate erosion and sediment control measures into the construction schedule.
- Include significant long-term operations or activities in the schedule that may have planned non-storm water discharges.
- Minimize earthwork during the local wet season (October 1st to April 1st).
- Install temporary sediment collection devices and stabilize disturbed soil areas before the wet season begins.
- Schedule work to minimize the extent of site disturbance at any one time.
- Establish final grade quickly and stabilize disturbed soils as soon as practicable (**Note: the NDEP 2015 General Construction Permit requires the application of stabilization measures no more than 14 days after construction activity has temporarily or permanently ceased.**)

Scheduling

PL-2

- The construction schedule (and the SWPPP) shall include the dates the following applicable BMPs will be installed:
 - Temporary soil stabilization BMPs
 - Temporary sediment control BMPs
 - Tracking control BMPs
 - Wind erosion control BMPs
 - Non-storm water BMPs
 - Waste management and material pollution control BMPs
- Use a calendar or flow chart to plan the construction and BMP implementation schedule.
- Outline the starting and completion dates of each item in a timetable (i.e. site clearing, grading, excavation, installation of utilities, etc.)
- Inventory and evaluate the existing site terrain and vegetation.
- Monitor weather forecasts for rainfall.
- Sequence trenching activities by closing open portions before new trenches are developed.
- Install erosion controls as work progresses.

Inspection and Maintenance:

- Verify that work is on schedule according to the project plan.
- Revise the schedule well in advance to prevent problems and to maintain control when changes to the schedule are unavoidable,
- Communicate significant schedule changes to city/county staff to assist with inspection efforts.

Phased Construction

PL-3



Source: USEPA

Purpose: To reduce on-site erosion and sediment transport off-site by sequencing land disturbance and erosion and sediment control measures.

Applications:

- Locations where water quality might be impacted by erosion from earthwork.

Limitations:

- Weather and other unforeseen conditions that may affect construction phasing.

Standards and Specifications:

- Construction phasing schedules shall include at a minimum the following:
 - A schedule for the installation of erosion and sediment controls.
 - A schedule that is compatible with the general construction schedule.

Phased Construction

PL-3

The following is an example of construction site sequencing:

- | | |
|---|--|
| 1. Signage | Install construction notice signs for site work, dust control, etc. |
| 2. Construction Access | Install stabilized construction entrances/exits (SC-8) before earth disturbing construction activities begin. |
| 3. Sediment traps and basins | Design and construct sediment traps and basins (SC-6 and SC-7) prior to stripping and grading. |
| 4. Runoff control | Install diversion channels and dikes (RC-2) before the onset of grading activities. |
| 5. Sediment Control | Install sediment control BMPs (SC-1 through 5) along downhill border of site. |
| 6. Erosion control | Stabilize disturbed soils as soon as possible. |
| 7. Land clearing and grading | Clear and grade the site after sediment and runoff control measures have been installed, inspected, and approved. |
| 8. Maintenance | Conduct frequent inspections and remove accumulated sediments from the BMPs. |
| 9. Surface stabilization | Apply immediately to any disturbed areas to control dust and erosion. |
| 10. Building construction | Properly store and contain materials. |
| 11. Maintenance | Conduct frequent inspections and remove accumulated sediments from the BMPs. |
| 12. Revegetate or Landscape and final stabilization | Stabilize the area and remove all temporary sediment control and construction wastes. Biodegradable controls may remain. |

Inspection and Maintenance:

- Verify frequently that work is on schedule according to the project plan.

- Revise the plan before construction activities are implemented when changes to the project schedule are unavoidable.

Communicate significant schedule changes to city/county staff to assist with inspection efforts.

Native Material Reuse

PL-4

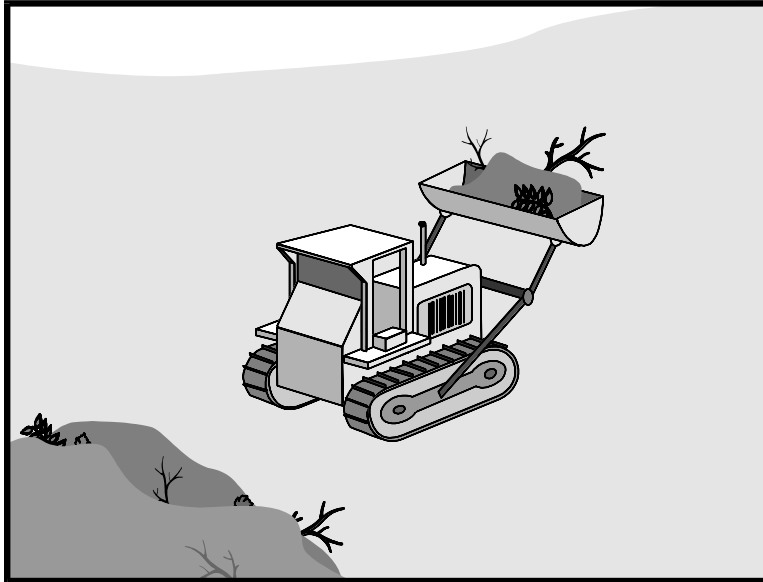

Graphics used with permission of Caltrans (with modifications)

Purpose: To encourage the salvaging, stockpiling and reapplication of native materials for reuse during revegetation activities. Reuse of native materials can be a critical factor to the success of revegetation and erosion control., only if native topsoil is not contaminated with noxious weed seeds.

Applications:

- Sites where revegetation is desirable.
- Particularly applicable on cut and fill slopes, floodplains, wetlands, streambanks, and sensitive habitat areas.
- Proper native material management can result in successful revegetation, enhanced productivity, reduced erosion, and permanent stabilization.

Limitations:

- Requires advanced planning prior to grading and earthwork activities.
- Stockpiles may constrict the area available for construction activity.
- May be limited area for storage; may require storage off site.
- Stockpile runoff can negatively impact water quality if improperly contained.
- Can become a source of undesirable weeds if not revegetated or properly stabilized using mulch and binders (tackifier).

Standards and Specifications:

- Conduct a site analysis including vegetation survey and soil analysis as part of pre-project site assessment to identify the location, depth, quality, and amount of material suitable for salvaging. At a minimum salvage material to a depth of six (6) inches.
- Excavate material carefully, avoid large rocks, and stockpile material where it will not be contaminated by demolition or construction activities. Screen to remove large rocks, and process organic matter when necessary to establish a representative native growth medium.
- If there is sufficient turf in good condition on site, it can be machine cut and stockpiled for reuse.
- Where suitable, strip groundcover and salvageable vegetation such as willows, roses, cactus species, and Joshua trees for reuse after construction. Carefully removed and store with specific protocol for each species.
- Soil stockpiles must be protected with temporary stabilization measures such as mulch or temporary revegetation. **DO NOT USE PLASTIC SHEETING.**
- Temporary stabilization must be established no later than 21 days after stockpiles are created.
- Perimeters controls such as sandbag barriers or fiber rolls must be installed as soon as practicable and must be in place prior to the onset of precipitation.

Consider the following elements when developing a topsoil management plan:

- The amount and quality of existing native material. Do not reuse if the area is contaminated with noxious weeds.
- The area where material will be reused and the required depth of application.
- Methodology for salvaging material.
- Stockpile location, duration of storage and protection against erosion and sediment transport.
- Availability and suitability of amendments to supplement revegetation.

Inspection and Maintenance:

- Inspect surface cover and perimeter controls weekly.
- Replace or repair or augment temporary stabilization measures as needed.
- Replace or repair perimeter controls as needed.

Employee Training

PL-5



Purpose: Ensure that contractors, subcontractors and government review and inspection staff are able to identify activities that may potentially impact storm water quality, identify possible solutions, and implement appropriate BMPs.

Applications:

- All construction intending to include grading or earthwork.

Limitations:

- None.

Standards and Specifications:

- Incorporate storm water quality management training with existing construction related training programs.
- Provide refresher courses or training classes on a regular basis.
- Include standard operating procedures and training in spill prevention and response.
- Train personnel in the proper use, storage, and disposal of pesticides and other construction related chemicals.
- Inform off-site contractors of on-site procedures.
- Conduct “tailgate” training sessions at project sites prior to the start of construction activities. Include discussion of Noxious and Invasive weeds.

Employee Training PL-5

Consider the following elements when developing a formal training course:

- Environmental concerns about runoff from construction sites.
 - The Clean Water Act and the NPDES program.
 - NDEP's 2015 General Permit and local policies and procedures.
 - Principles of erosion and sediment control.
 - Best Management Practices and appropriate applications.
 - Proper design and installation procedures.
 - Inspection, maintenance, and reporting requirement.
 - Weed identification.

Section 7: Runoff Control Best Management Practices

This section presents the temporary and permanent facilities that can be constructed to intercept, divert, and convey concentrated flows away from disturbed soil areas. These facilities can be constructed onsite or upstream of the site. Runoff control BMPs can be used alone or in combination with erosion control measures to direct run-on around or through the project in a non-erodible fashion.

Table 7-1: Runoff Control Best Management Practices			
BMP#	BMP Name	Temporary	Permanent
RC-1	Permanent Diversions		P
RC-2	Temporary Diversion Berms and Ditches	T	
RC-3	Check Dams	T	
RC-4	Temporary Slope Drains	T	

Permanent Diversions

RC-1

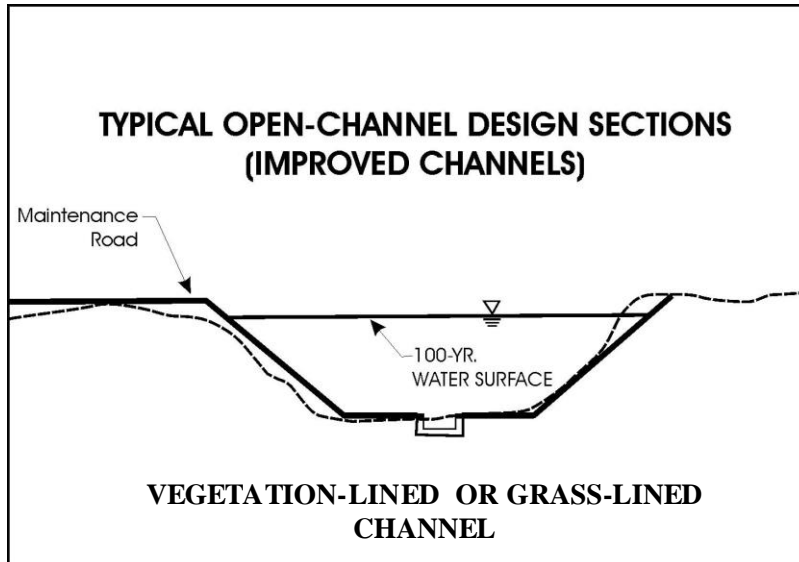

Graphic produced by Kennedy/Jenks Consultants

Purpose: To design permanent facilities to collect storm water runoff and/or stream flow and convey it away from disturbed ground to an appropriate outlet or downstream drainage channel.

Applications:

- To decrease the likelihood of runoff from upstream watersheds that could result in property damage or erosion.
- To protect upland slopes by reducing slope lengths and minimizing erosion and soil loss.
- To reduce runoff velocities and increase stability by reducing channel slope and adding channel liners.

Limitations:

- Watershed and/or contributing drainage area modeling and engineering design are generally required.
- Constructed channels must be stabilized so that they are not subject to the same erosion potential as the disturbed areas they are meant to protect.
- May require additional measures to ensure channel stability and function.

Permanent Diversions RC-1

7.1

Standards and Specifications:

Open Channels for Storm Water and Diverted Stream Flows

- Permanent open channels must be designed by a professional registered engineer in the State of Nevada according to the criteria outlined in the drainage design manual of the appropriate jurisdiction.
 - Reno – Public Works Design Manual, 2010.
 - Sparks and Washoe County – Hydrologic Criteria and Drainage Design Manual, latest edition.
- Refer to the drainage design manual of the appropriate jurisdiction regarding velocity limitations, channel liners, channel drops and energy dissipation structures.
- If intended to also function as a permanent post-construction structural treatment control BMP (e.g. a vegetated swale), design per the criteria presented in the current version of the Truckee Meadows Structural Controls Design Manual.
- Where feasible, establish and install vegetated swales prior to the swale receiving run-off (with established vegetation) down slope of proposed construction sites prior to the commencement of major earth disturbing activities.

Paved Flumes

- Divert storm water runoff down the face of slopes without causing erosion problems on or below the slope.
- Outfall protection must be provided to prevent damage from high velocity flows.
- Maximum slope of the flume structure shall not exceed 1.5 H:1V.
- Install cutoff walls at upstream and downstream ends and along the length of the flume to prevent undermining.
- Place anchor lugs shall along the length of the flume to prevent movement.
- Install expansion joints and transverse joints along the length of flumes.
- Outlets must be protected using the appropriate energy-dissipating structures.

Outlet Protection

Permanent Diversions

RC-1

- Structurally lined aprons or other energy dissipating devices placed at the outlets of pipes to decrease the velocity of storm water flows.
- No bends shall be present in the horizontal alignment.
- Invert elevations shall be equal at the receiving channel and at the downstream end of the apron.
- No overfall shall occur at the end of the apron.
- Side slope of the receiving channel shall not be steeper than 2H:1V.
- Riprap, grouted riprap, concrete, or gabion baskets shall be used to line the apron.
- Where velocities warrant, filter cloth or rolled erosion control products such as coconut netting shall be placed between the channel and the riprap to prevent soil movement.
- Additional specifications are provided on the Storm Drain Outlet Protection (DP-2) fact sheet.

Inspection and Maintenance:

- Inspect channels and outfalls a minimum of once a week and after every rainfall until the area is stabilized.
- Inspect competency of riprap or channel lining after runoff events.
- Keep channels clear of sediment.
- Reseed areas if vegetative cover is not established.

Temporary Diversion Berms

RC-2

Dikes & Ditches

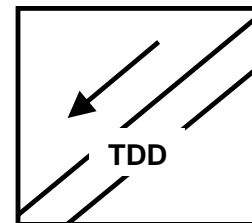
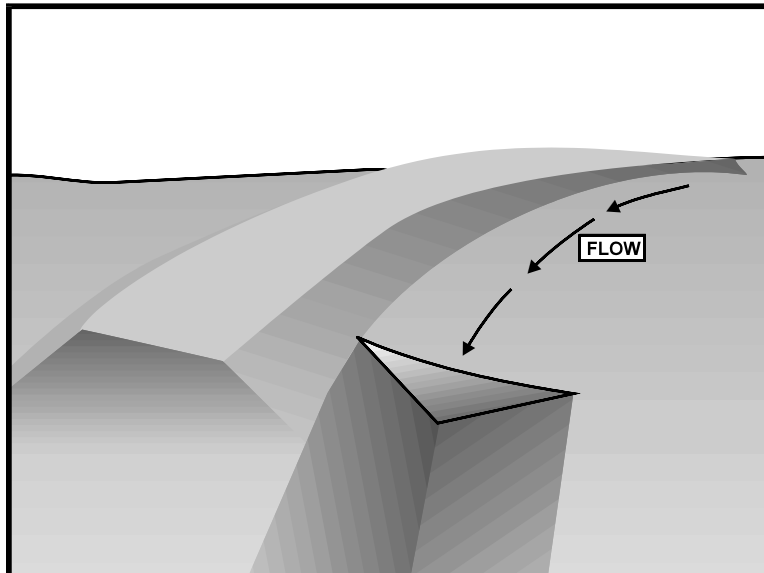

Map Symbol

Graphics used with permission of Caltrans

Purpose: To prevent erosion by capturing and diverting runoff away from above unprotected slopes. Also used along the perimeter of construction sites to prevent runoff from leaving the site. Use temporary diversion berms and dikes, ditches and swales to convey runoff to sediment trapping devices, stabilized outlets or level spreaders, where appropriate.

Applications:

- Used on upslope of disturbed areas.
- Located at the perimeter of construction sites.
- Intercept runoff from paved surfaces.
- Direct runoff to sediment trapping devices or stabilized outlets.

Limitations:

Temporary Diversion Berms and Dikes

- Do not remove or trap sediments.
- Surrounding slopes shall not exceed 5 percent.
- Upstream drainage areas shall not exceed 5 acres.
- Dikes may become barriers to construction equipment.
- Concentrated runoff may damage adjacent areas.
- Diversion dikes shall not cross roadways.

Temporary Diversion Berms

RC-2

Dikes & Ditches

- Dikes must not adversely affect upstream or downstream properties.
- Berms are erodible if not correctly constructed.

Limitations:

Temporary Diversion Ditches and Swales

- Must conform to local floodplain management regulations and shall not adversely impact upstream or downstream properties.
- Not to be used as sediment trapping devices.
- Scour and erosion in newly graded swales and ditches may occur.
- Ditches and swales may require lining or check dams to prevent erosion and gully formation.
- Can be expensive if engineering design is required.
- Vegetation and ponded water in the bottom of these facilities can provide midge and mosquito habitat.

Standards and Specifications:

- Firmly compact dikes, berms, ditches and swales to minimize erosion and prevent unequal settling.
- Drain dikes, berms, ditches and swales to protected outlets and/or sediment trapping devices.
- Provide a continuous grade to prevent water from ponding.
- Keep in place until the disturbed area is permanently stabilized.

Temporary Diversion Dikes & Berms

- Dikes & Berms shall have the following minimum dimensions: top width of 24 inches, height of 18 inches, and side slopes of 2H:1V or flatter.
- When revegetation is not possible, stabilize with filter cloth if necessary to reduce erosion potential.

Temporary Diversion Ditches and Swales

- No bushes, trees, shrubs, straw bales or silt fences shall be located within ditches or swales.
- Stabilization with liners and/or check dams is required when channel grades exceed 2 percent or velocities are in excess of 6 feet/second.

Temporary Diversion Berms

RC-2

Dikes & Ditches

Level Spreaders

- Provides an outlet from a temporary runoff diversion and consist of a lowered section in the sidewall of a temporary dike or swale.
- Spreads storm water runoff over the ground as even shallow flow instead of through channels.
- Only to be used for runoff that is relatively free of sediment.
- Construct of 2 to 4 inch washed gravel at zero grade.
- Design length based on drainage area and design flow.

Drainage Area (acres)	Minimum Spreader Length (feet)
1	10
2	10
3	15
4	18
5	20

- Height of spreader based on depth of design flow.
- Lip of spreader shall be a gravel berm a minimum of 6 inches high.
- Width of spreader shall be 6 feet minimum.
- Slope of the undisturbed outlet must not exceed 6 percent.
- Construct level spreaders on natural soil and not on fill material or easily erodible soils.
- Grade of runoff diverter entering the spreader shall be less than one percent for at least 20 feet upstream of the spreader
- Do not allow heavy equipment or traffic onto the level spreader.
- Regrade the spreader if ponding or erosion channels begin to develop.

Inspection and Maintenance:

- Inspect every week and after rainfall events for debris buildup or damage to dikes, ditches, swales and liners.
- Remove accumulated sediment and debris and repair embankments and repair linings as needed.
- From May to October, do not allow water to pond behind dikes or in ditches or swales for more than 48 hours.

Temporary Diversion Berms

RC-2

Dikes & Ditches

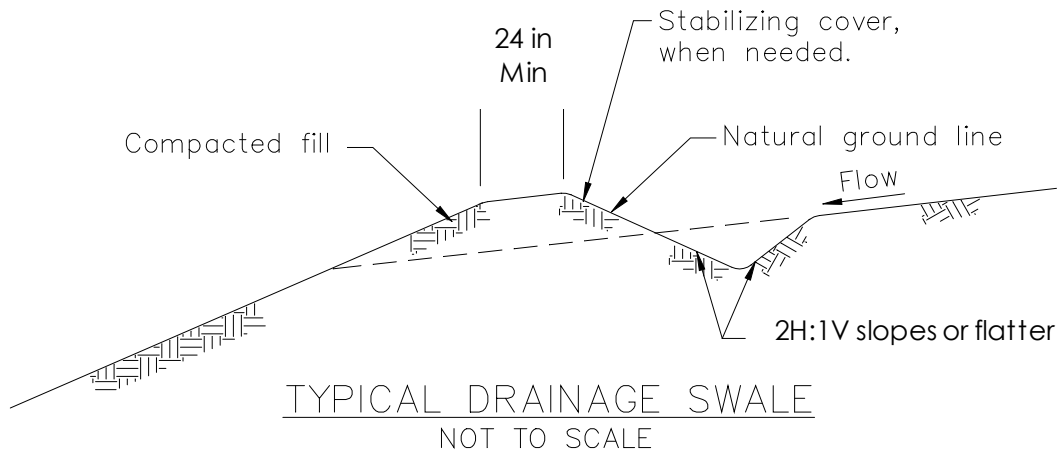

NOTES:

1. Stabilize inlet, outlets and slopes.

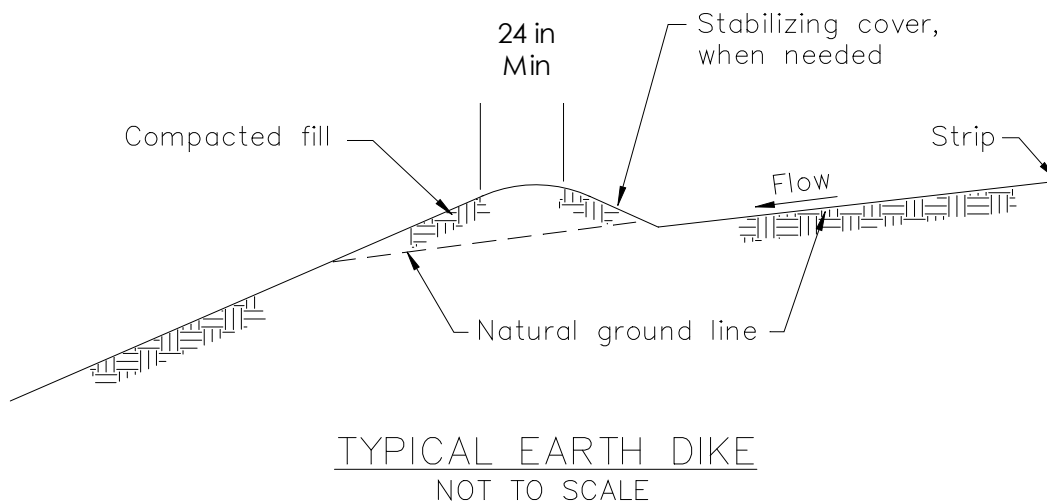

Graphic used with permission of Caltrans.

Check Dams

RC-3

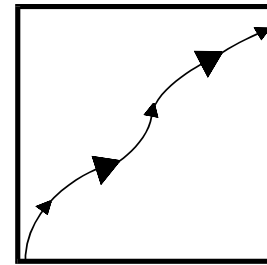
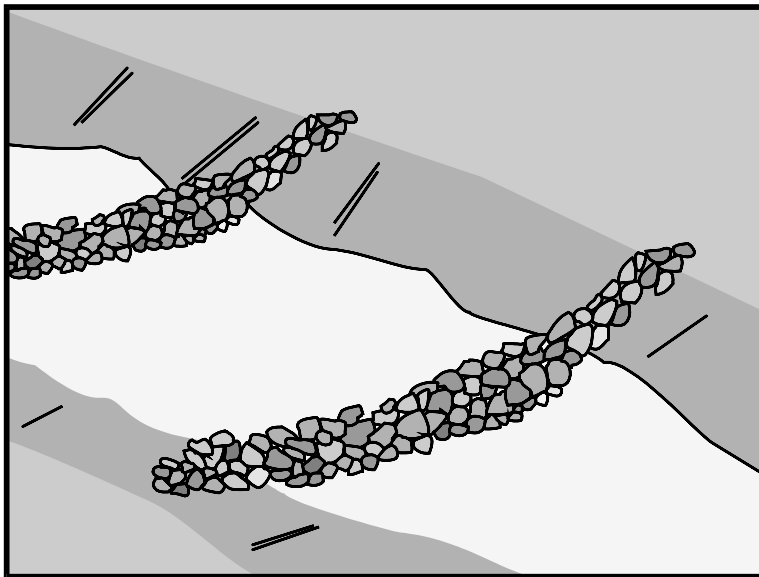

Map Symbol

Graphics used with permission of Caltrans

Purpose: To reduce erosion in channels, swales and ditches caused by high flow velocities through the installation of temporary dams constructed of rocks or gravel bags. Check dams reduce flow velocity and channel scour and encourage sediment deposition. Fiber rolls can also be used in low flow and low gradient drainage swales (< 1 cfs and < 3H:1V), provided they are securely anchored in place.

Applications:

- Used in small open channels draining 10 acres or less.
- Used in steep channels when runoff velocities exceed 3 feet/second.
- Used when establishing grass linings in channels or drainage ditches.

Limitations:

- Do not use in live streams.
- Do not use in channels draining areas greater than 10 acres.
- Do not construct a check dam with silt fencing or straw bales.
- Check dams shall not be used as primary sediment-trapping devices.
- Extensive maintenance may be required following high flow events.
- Check dams typically trap sediment, which can be re-suspended during subsequent storm events and during check dam removal.

Standards and Specifications:

- Place check dams at a distance and height to allow small pools to temporarily form behind them.
- Space the dams at regular intervals based upon soil types and slope gradients.
- Use clean rock riprap with the D_{50} ranging 3 and 6 inches in diameter.

Check Dams

RC-3

- Install the first check dam approximately 16 feet downstream of the outfall device. Steeper channel slopes and more erosive soils require shorter spacing intervals between check dams.
- Space check dams such that the downstream toe of each dam meets the backwater from the next downstream check dam.
- Design check dams to pass a 2-year, 24-hour storm without causing damage to the dam or any upstream flooding.
- The maximum height of a check dam is 4 feet from the upstream toe to the crest and the center of the dam.
- Construct the crest and the center of the dam 6 inches lower than the edges.
- Install (keyed) dam materials at least 6 inches into the sides and bottom of the channel.
- Do not dump rocks when constructing check dams. Placed rocks individually by hand or by mechanical methods.
- If gravel bags are used in the construction of check dams, follow the design criteria presented in BMP fact sheet SC-3 (do not use sand bags).
- If fiber rolls are to be used as check dams in low flow (< 1 cfs) and low gradient (< 3H:1V) drainage swales, they must be securely anchored in place (e.g. keyed-into the soil at least 1/3 the diameter of the fiber roll and staked in place) and follow the design criteria presented in BMP fact sheet SC-1.
- Check dams should be removed once vegetation has been established in a channel. However, check dams may be left in place if they are designed as permanent structures and in accordance with local drainage policies.
- From October to May, do not allow water to pond behind check dams for more than 48 hours.

Inspection and Maintenance:

- Inspect regularly and after each runoff event for sediment buildup and signs of erosion under or around the dam.
- Replace loose material.
- Remove accumulated sediments when it reaches one third of the check dam height.
- Remove accumulated sediments prior to performing soil stabilization or permanent seeding practices.
- Remove check dam and accumulated sediments when dams are no longer needed.
- Dispose of accumulated sediments properly.

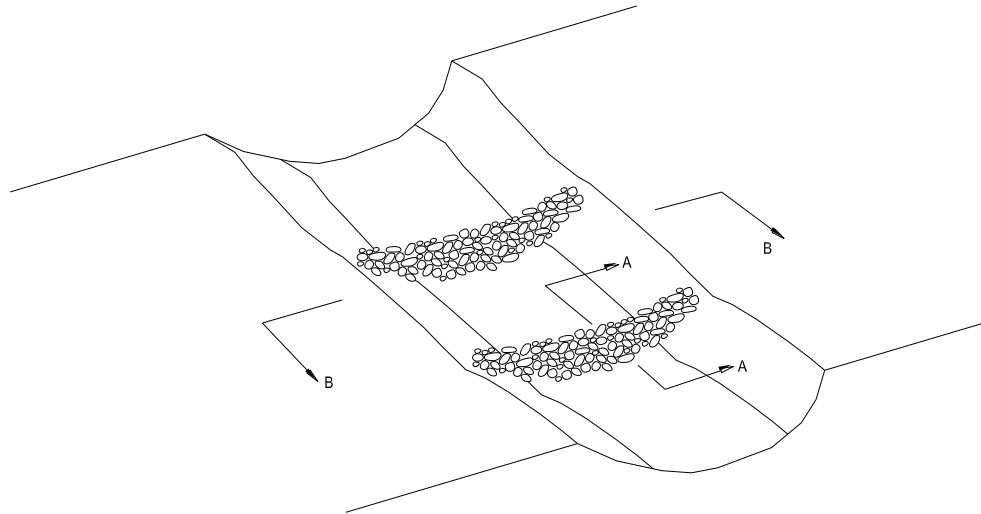

TEMPORARY CHECK DAM
(ADAPTED FROM CALTRANS)

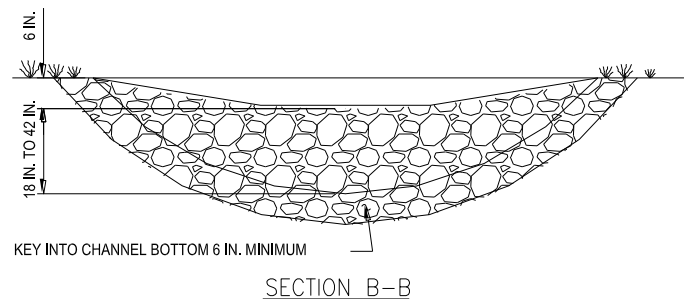
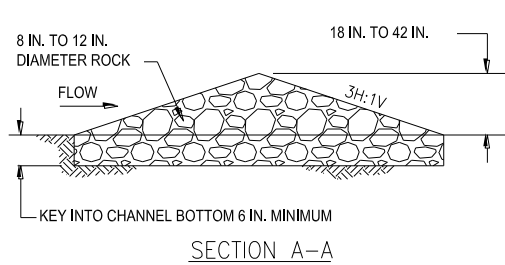

ROCK CHECK DAM
NOT TO SCALE

Graphics adapted from Caltrans.

Check Dams

RC-3

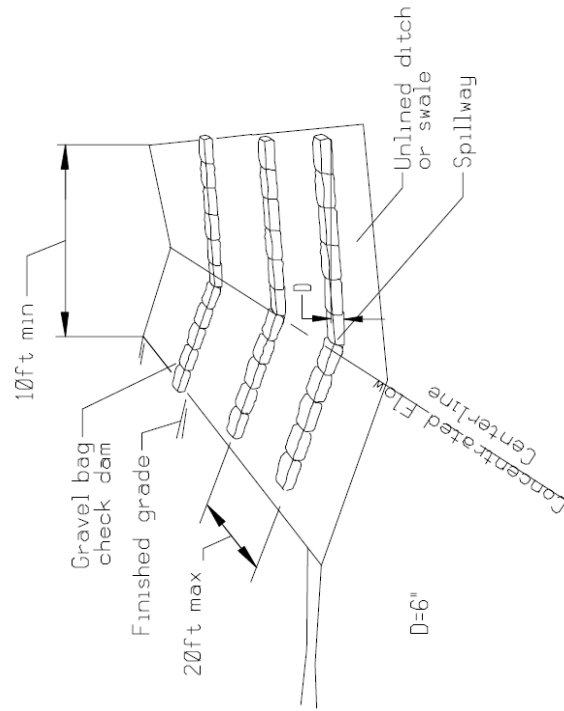

PERSPECTIVE

TEMPORARY CHECK DAM (TYPE II)

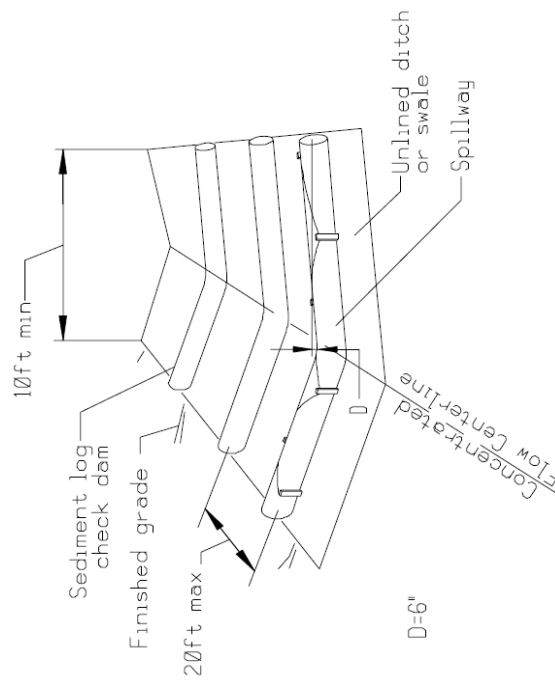

PERSPECTIVE

TEMPORARY CHECK DAM (TYPE I)

NOTES

1. Spillway depth "D" shall be maintained to prevent flanking of concentrated flow around the ends of the check dam.

Graphics adapted from Caltrans.

Temporary Slope Drains

RC-4

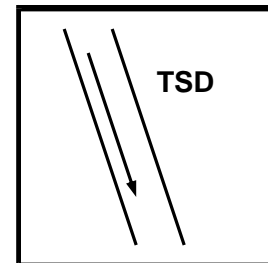
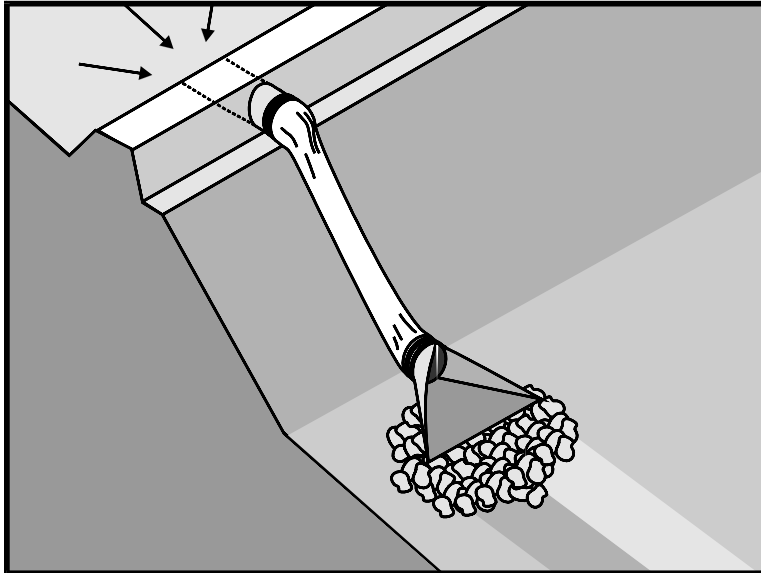

Map Symbol

Graphics used with permission of Caltrans

Purpose: Used as a temporary measure to convey concentrated runoff across a slope to a stabilized discharge point without allowing erosion to occur.

Applications:

- Used on construction sites where surface runoff may cause slope erosion.

Limitations:

- Clogged slope drains can cause flooding and severe erosion.
- High flows must be dissipated to avoid downstream erosion.
- Slope disturbance can occur during construction and removal of drains.

Standards and Specifications:

- Size at a minimum to convey the peak flow from the 2-year, 24-hour storm.
- Maximum drainage area per pipe is 5 acres.
- Slope drains should not be used on slopes steeper than 2H:1V.
- Compact soil around inlet, outlet and along length of pipe
- Inlet must be securely entrenched and protected with filter fabric cloth.
- Use gasketed watertight fittings.
- Pipes can be either placed on the surface or buried beneath the slope.

Temporary Slope Drains RC-4

- Install pipes perpendicular to slope contours.
- Protect area around inlet with filter fabric.
- Stabilize the outlet using riprap or other materials to dissipate energy using the criteria outlined in the drainage design manual of the appropriate jurisdiction.

Inspection and Maintenance:

- Inspect weekly and after every storm event that creates runoff.
- Inspect the inlet for undercutting and the outlet for scour.
- Inspect for accumulations of sediment and debris.
- Remove accumulations of sediment and debris prior to the next forecasted storm event.
- Do not allow water to pond in inappropriate areas (e.g. active traffic lanes, material storage areas, etc.).

Temporary Slope Drains

RC-4

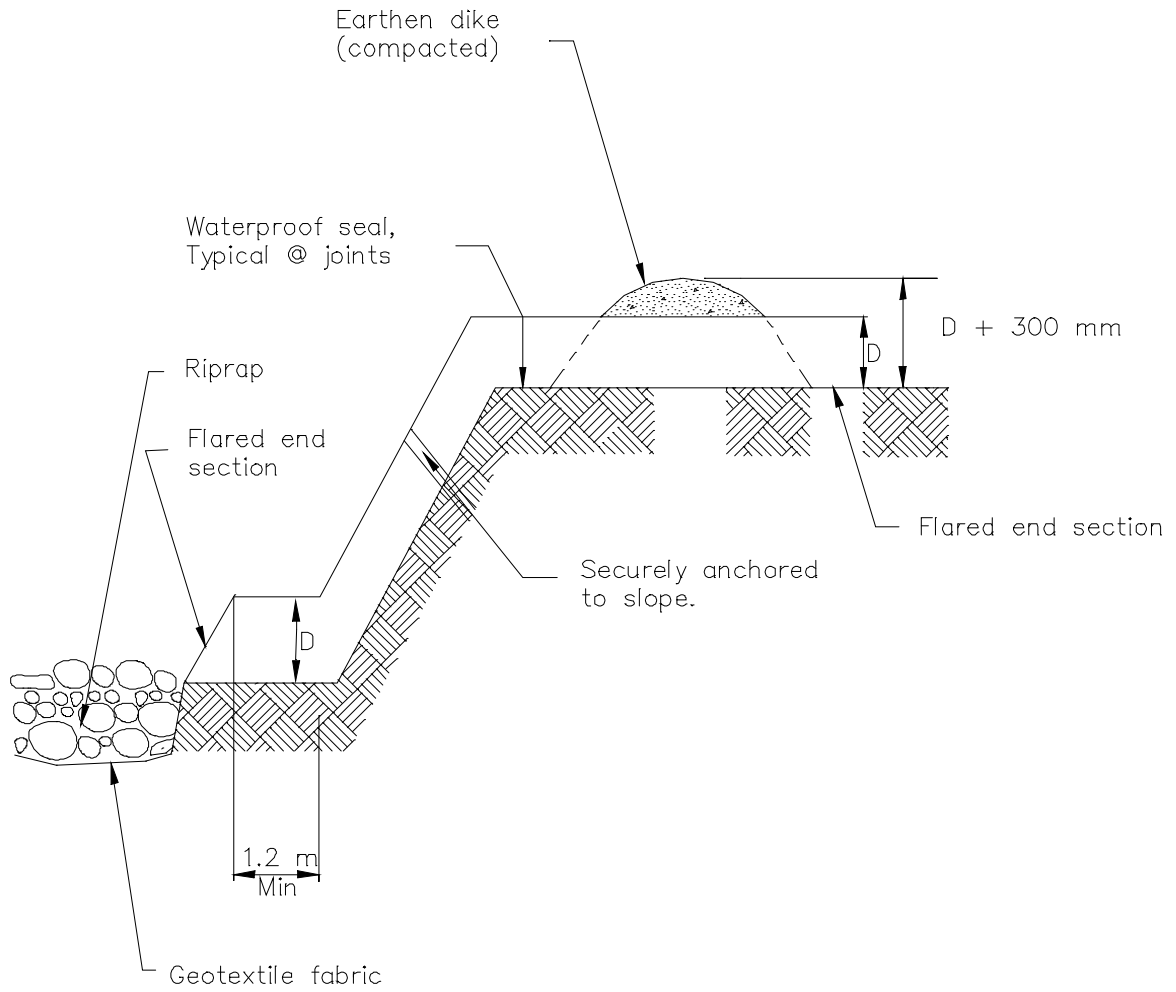

TYPICAL SLOPE DRAIN
NOT TO SCALE

Graphic used with permission of Caltrans.

Section 8: Erosion Control Best Management Practices

This section represents the measures that can be applied to control erosion at construction sites (as source control). Preservation of existing vegetation (EC-1) reduces the amount of erodible area and provides buffer zones between bare soil areas and waterways or the storm drain system. The other measures presented in this section are those that can be directly applied to disturbed soils to reduce erosion by wind, rain and runoff. Erosion control is typically the most effective method of controlling discharges from construction sites.

Table 8-1: Erosion Control Best Management Practices

BMP#	BMP Name	Temporary	Permanent
EC-1	Preserving Existing Vegetation	T	P
EC-2	Slope Terracing and Tracking	T	P
EC-3	Mulching	T	P
EC-4	Soil Binders	T	P
EC-5	Wind Erosion and Dust Control	T	P
EC-6	Rolled Erosion Control Products	T	P
EC-7	Riprap	T	P
EC-8	Revegetation	T	P

Table 8-2: Soil Cover and Erosion Control

Soil Cover Condition	Erosion Reduction Potential
Certified Weed-Free Straw Mulch	
0.5 ton/acre	75%
1.0 ton/acre	87%
2.0 tons/acre	98%
Grass – Seeding and Sod	
40% cover	90%
60% cover	96%
90+% cover	99%
Trees and Bushes	
25% cover	58-60%
75% cover	64-72%
Rolled Erosion Control Products	95-99%
Reference: Fifield, 2002	

Preserving Existing Vegetation

EC-1

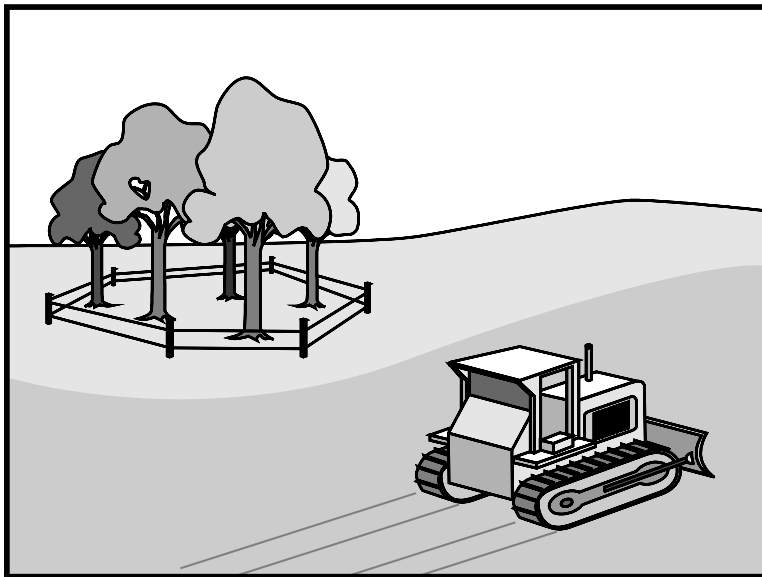

Graphics used with permission of Caltrans

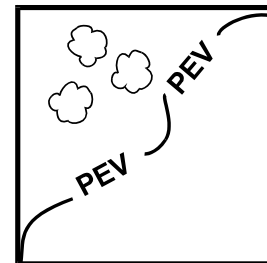

Map Symbol

Purpose: To protect and preserve existing desirable plants and trees in and near areas that will be exposed to land-disturbing activities. Protecting and preserving landscaped and/or native vegetation can reduce the amount of erodible area and provide buffer zones that assist with infiltrating runoff and trapping sediment so that it does not discharge to waterways or the storm drain system.

Applications:

- Can be used on all types of construction sites.
- Applicable on floodplains and steep slopes, and next to wetlands, streams, rivers, lakes, and sensitive habitat areas that have existing desirable vegetation.

Limitations:

- Requires advanced planning.
- May constrict the area available for construction activity.
- High real estate values may not allow for the preservation of some natural areas.
- Improper grading may negatively impact vegetation.

Standards and Specifications:

- Install high visibility temporary fencing to protect high value existing vegetation before beginning clearing or other soil-disturbing activities.

- Wherever possible, preserve desirable vegetation on steep slopes and near perennial and intermittent watercourses or swales.
- Wherever possible, preserve contiguous areas or clumps of native or landscaped vegetation, instead of individual trees and shrubs.
- Consider the location, species, size, age, and vigor of existing vegetation.
- Local agencies may have ordinances to save vegetation.
- Consider tree health, age, species, space needed, aesthetic values, and wildlife benefits when deciding which trees to preserve.
- Follow existing contours and avoid stands of trees when locating temporary roadways.
- Do not place equipment, construction materials, native materials, topsoil, or fill dirt within the limits of preserved areas.
- Maintain existing irrigation systems.
- Consider installing retaining walls to additionally protect vegetation.
- Fires are not permitted within 100 feet of the tree drip line.
- At a minimum, extend limits of fencing to the tree drip line (end of tree branches) when protecting trees. Wherever possible, extend the limits of the no-dig root protection zone outward such that it is twice as large as the outer perimeter of the branches.
- Do not cut tree roots within the tree drip line. Curve trenches around tree drip lines to avoid large root concentrations.
- Smoothly cut off the ends of damaged roots.
- Consult local arborist where appropriate.

Inspection and Maintenance:

- Repair or replace damaged vegetation immediately. Smoothly cut off the ends of damaged roots.
- Monitor the protected areas to ensure that new structures won't compromise vegetation.
- Loosen compacted soil around the tree root zone.
- Consult an arborist to determine if soil amendments or fertilizers are needed to maintain tree health.
- If advised fertilize trees in late fall or early spring.
- Cover exposed tree roots with damp soil or a wet burlap as soon as possible.

Slope Terracing and Tracking

EC-2

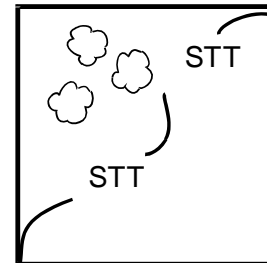
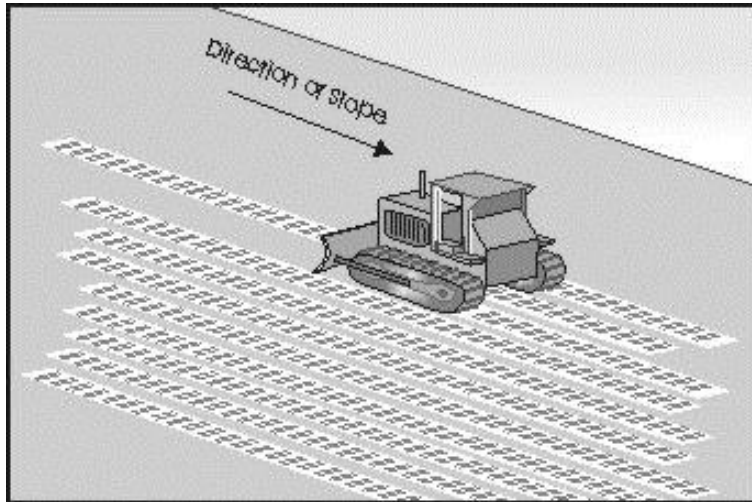

Graphics produced by Kennedy/Jenks Consultants

Purpose: Terracing and soil roughening or tracking of slopes reduces erosion by creating stair-steps, furrows across slope and serrations in the soil. Uneven bare soil surfaces capture raindrops, decrease the velocity of runoff, trap sediments, increase infiltration into the soil, decrease wind velocity, and aid in the establishment of vegetation.

Applications:

- Appropriate for all construction sites, particularly sites with uneven or steep topography or easily erodible soils.
- Applicable on graded areas that have smooth and hard surfaces.
- To be used in conjunction with seeding, planting, and mulching for temporary and permanent erosion control.

Limitations:

- Soil roughening may increase grading costs, cause sloughing in certain soil types, and is not needed on rocky slopes.
- Stair-step grading or terracing may not be appropriate for sandy, steep, or shallow soils.
- Effectiveness of soil roughening or tracking is limited when used alone in intense rain events.
- Terracing installed as a permanent measure to shorten slope length shall be designed based on site-specific conditions and under the direction and approval of a registered professional civil engineer.

Standards and Specifications:

- Consider the following in grading plans:
 - The effects of grading on drainage patterns.
 - Soil type.
 - Access.
 - Type of equipment (dozer, imprinter, etc.).
 - The effects of runoff on receiving waters.
 - Starting and ending dates for movement of earth materials.
 - The percent, length, and aspect of the finished slopes.
 - How and where excess materials will be disposed.
 - Berms, diversions, and other storm water practices.
 - Site fingerprinting (clearing and grading only those areas necessary for building activities or movement of equipment).
- Roughening methods include: stair-step grading, grooving, tracking, and rough grading.
- Stair-step graded areas steeper than 3H:1V with benches.
- Mowed areas (slopes less than 3H:1V) may have small furrows left by disking, harrowing, raking, or seed-planting machinery.
- Use terraces where the slope length needs to be shortened.

Inspection and Maintenance:

- Inspect tracked, mulched, seeded and planted slopes for gullies or rills, after storm events.
- Repair immediately small-scale eroded areas to prevent them from developing into significant gullies.
- Inspect terraces annually and after significant storm events.

Mulching

EC-3

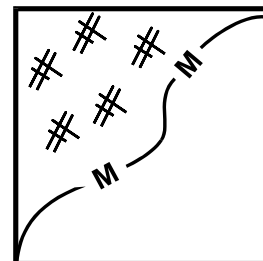
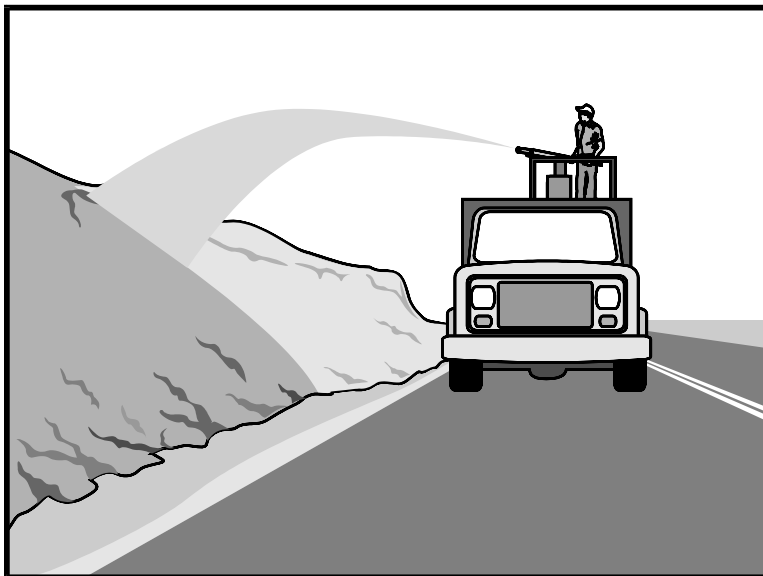

Map Symbol

Graphics used with permission of Caltrans

Purpose: To prevent erosion by protecting bare soil from rainfall and wind, reducing runoff velocity, conserving moisture, and fostering plant growth. Mulches can be composed of straw, wood chips, bark, pine needles, recycled paper, wood fibers, cotton, flax, or gravel, and they act to protect soil and enhance seed germination by reducing evaporation and insulating the soil.

Applications:

- Applicable to all bare soil surfaces where construction activities will cease for 14 days or more and will not resume within 21 days.
- Provides a temporary or permanent cover and aids in stabilization measures.
- Immediately follow temporary and permanent seeding of an area with mulching.

Limitations:

- Additional control measures may be necessary for the establishment of vegetation if the area is susceptible to erosion.
- Straw and wood chip mulch require removal before soil stabilization or permanent seeding is to take place.
- Straw and wood mulch are prone to removal by runoff and wind if not correctly anchored.

- Wood fiber hydraulic mulches may be short-lived. Recycled paper lasts longer.
- A strong potential for introducing weed-seed and unwanted plant material exists with use of pine needles and un-certified straw.

Standards and Specifications:

- The type of mulch to be applied depends on soil type, site conditions, landscape requirements, and economics.
- Roughen embankments and fill areas before applying mulch.

Straw Mulch

- Used as a temporary or permanent surface cover on disturbed areas until vegetation can be established.
- Apply at a minimum rate of 4,000 lb per acre.
- Straw mulch can be anchored by crimping, punch roller-type rollers, or track-walking, and /or with binders.
- The area must be within 150 feet of a roadway if straw blowers are to be used in the application of the mulch,
- Do not place straw in lined drainage channels, on sidewalks, or on sound walls.
- Use certified weed-free mulch.

Wood Chip Mulch and Shredded Wood

- Primarily used as a temporary ground cover around trees, shrubs, and landscaping.
- Apply by hand and distribute mulch as a layer 2-3 inches thick for landscaping and weed control.
- Apply one layer deep for revegetation applications.
- Will float or move on slopes 3:1 and steeper.

Green Material/Compost

- Don't use as mulch.

Hydraulic Mulches made from recycled paper

- Composed of a mixture of recycled newsprint, magazines, or other paper waste products.
- Mulch mixed with seeds, inoculants, and tackifier and can be applied on many sites.
- Erosion control effectiveness is limited by the short fiber length and lack of tackifier.
- Life span is generally longer than wood fiber mulches.

Hydraulic Mulches made from wood fiber

- Wood fiber mulch can also be made from lumber mill waste.
- Provides limited erosion control even with tackifier.

Hydraulic matrices (Bonded Fiber Matrix)

- Hydraulic slurries are a mix of wood or cellulose fiber held together by a chemical or mechanical bond.
- The mixture does not dissolve upon rewetting or contain any growth inhibitors.
- Application rates range between 3,000 lbs/acre to 4,000 lbs/acre.
- Do not apply immediately before, during, or after rainfall. Allow 24 hours of drying before application.
- Slopes must be pre-wetted prior to application.
- Excellent on highly erodible slopes.
- More expensive than other methodologies.

Inspection and Maintenance:

- Inspect for failures and loss of mulch during the wet season.
- Reapply immediately if disturbed.

Soil Binders

EC-4

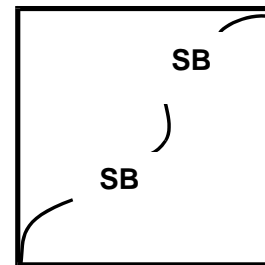
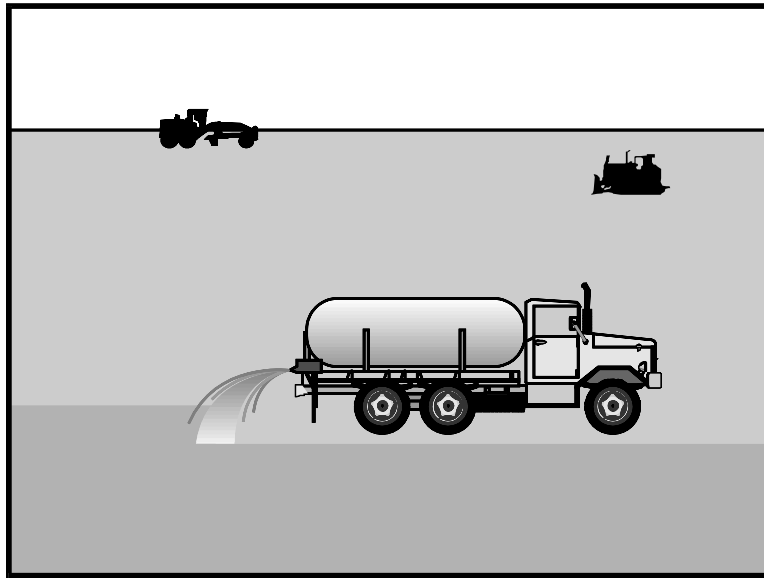

Map Symbol

Graphics used with permission of Caltrans

Purpose: To provide temporary or permanent stabilization of disturbed soils.

Applications:

- Locations where other methods such as temporary or permanent seeding of vegetation are not appropriate.
- Used in combination with vegetative or perimeter practices to enhance erosion and sediment control.

Limitations:

- Synthetic stabilizers are expensive compared to plant-derived binders.
- Soil binders are short lived and may need to be reapplied.
- Some binders need at least 24 hours to become fully effective.
- Heavy rainfall may cause localized failures.
- Soil binders are made ineffective by pedestrian or construction traffic.
- Soil surfaces comprised of compacted silts and clays may be impenetrable to soil binders.
- Low temperatures may not allow soil binders to cure.
- Some soil binders do not perform well in climates with low relative humidity.
- Some chemical binders inhibit germination and plant establishment.

Standards and Specifications:

- Soil binders must be non-toxic to plants and animals, easy to apply, easy to maintain, and not stain paved surfaces.
- Do not allow overspray

Types of soil binders:

- Copolymer – Provides long-term soil stabilization (1-2 years) and is compatible with existing vegetation. However, it is relatively costly. 80 – 100 gallons/acre is the suggested application rate.
- Psyllium/Guar – Good for short-term application. They are cost effective.
- Starch can also be used.

Factors to consider when choosing a soil binder:

- Consider where the soil binder will be applied.
- Soil type and frequency of application.
- Follow the manufacturer's recommended application rates and procedures.
- Roughen embankments and fill areas prior to application of soil binders.
- Do not apply soil binders during or immediately after rainfall.
- Do not apply soil binders to frozen soils or areas with standing water or during rainy conditions or when the temperature is less than 40°F.
- Allow 24 hours for soil binders to cure.

The application of liquid agents requires:

- Proper mixing.
- Re-application for extended longevity.

Inspection and Maintenance:

- Inspect regularly.
- Reapply as needed.

Wind Erosion and Dust Control

EC-5

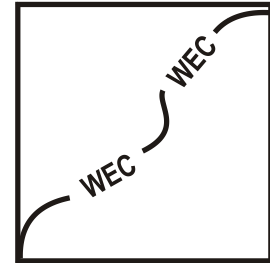
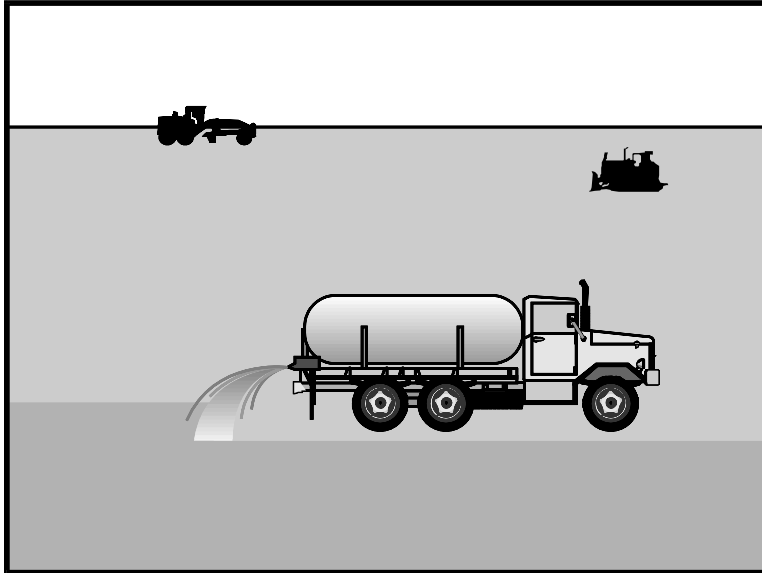

Map Symbol

Graphics used with permission of Caltrans

Purpose: Storm water runoff, wind, erosion, and vehicle trackout from construction sites can re-disperse sediments to the air by high winds and traffic. Therefore, the purpose of dust control is to minimize these effects.

Applications:

- All construction sites having exposed soils must perform dust control measures.
- Wind erosion and dust control is important in arid and windy regions.
- Areas with soils with fine particles (silts and clay) are more prone to dust if the surface is disturbed.
- Dust control is a permanent or treatment between but must be adequate upon project completion.
- Dust control methods can help to minimize pollutants in the storm drain system, are generally inexpensive.
- Wind fence (snow fence) are applicable in arid regions where large areas of cleared land are susceptible to blowing sand and dust.

Limitations:

- During construction dust control measures are only temporary and may require reapplication.
- Incorrect usage of chemical stabilizers can have adverse effects on water quality.

- Discharges from the site can occur if excessive water is applied resulting in runoff.
- Factors such as soil type, temperature, humidity, and wind velocity will impact the effectiveness of the dust control measures.
- Wind fences do not control sediment carried in storm water runoff. Install additional sediment and erosion control measures to capture sediment in runoff (see Section 9).

Standards and Specifications:

- Follow District Health Department standards and specifications when applying dust control measures at construction sites.
 - Wind fences are barriers made of small, evenly spaced wooden slats or fabric. They are erected to reduce wind velocity and to trap blowing sand.
 - Erect wind fences perpendicular to the prevailing wind source. Multiple fences may be erected to help prevent wind erosion. Software packages are available to assist with proper design.
 - Reduce disturbance of soil crust.
 - Other techniques used to control and minimize dust include the application of coarse gravel.
 - Magnesium chloride, resins, and lignin sulfonate may be used on roads where revegetation will not occur as these products inhibit plant establishment.
- Application
 - Moistening road surfaces is an effective dust control method for traffic routes.
 - This technique is short term and requires constant reapplication especially in windy areas.
 - Apply 0.03 - 0.3 gal/yd² uniformly to pre-wet the soil surface.
 - Apply 0.125 gal/yd² every 20-30 minutes.
 - Reactivate chemicals in dry climates by rewetting with 0.1 - 0.2 gal/yd².
 - Avoid ponding.
 - Use a pressure-type distributor or a pipeline equipped with a spray system to evenly distribute water for dust control.
 - Provide a positive means to shutoff distribution equipment.
 - Provide at least one water truck or hydroseeder to apply water or dust palliative to the construction site.
 - If non-potable water is used for dust control, all tanks, pipes, and other conveyances shall be clearly marked with "NON-POTABLE WATER – DO

NOT DRINK". There shall be no connection between potable and non-potable water.

Inspection and Maintenance:

- Daily inspections shall occur for areas experiencing excessive winds, vehicle traffic, or rains. If dust is observed to be leaving the site, take corrective action.
- Inspect wind fences periodically for damage and repair as needed.

Rolled Erosion Control Products

EC-6

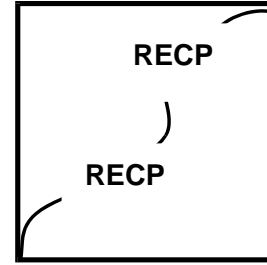
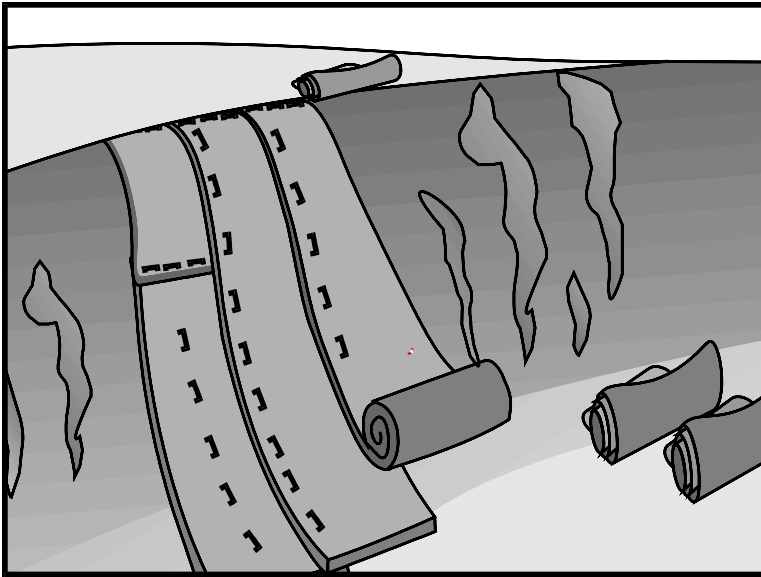

Map Symbol

Graphics used with permission of Caltrans

Purpose: To protect soils from wind and water and to stabilize disturbed soil areas through the installation of geotextiles, erosion control blankets, cellular confinement systems, or turf reinforcement mats.

Applications:

- Effective on steep slopes (3H:1V or greater) with high erosion potentials, slopes that are adjacent to streams or wetlands, on disturbed soils that are slow to establish vegetative cover, and on slopes where mulch must be anchored. Can also be applied in stream channels where flow velocities exceed 3.3 ft/sec.
- Biodegradable materials (straw, coconut, or a combination thereof) are preferred in arid climates.

Limitations:

- RECPs are not appropriate for sites that will be mowed or that have uneven surfaces that limit good soil contact.
- They cannot be installed where a key (anchor) trench cannot be excavated (e.g. excessive rock or vegetation)
- Erosion control blankets and geotextiles are rarely used as a temporary control measure.
- Erosion control blankets and geotextiles tend to be more expensive than other erosion control methods due labor costs and material expenses.
- Only use turf reinforcement mats (TRMs) with irrigation or where there is surface hydrology (e.g. wetlands) or groundwater adequate to support vegetation.
- Do not use plastic sheeting.

Standards and Specifications:

- Factors to consider when choosing an erosion control blanket include cost, effectiveness, longevity, dimensions, velocity, vegetation inhibition/enhancement, ease of installation, and operation and maintenance.
- Secure in place with biodegradable stakes. Steel wire staples are not as effective as wood stakes for most applications. They must be a minimum of 11 gauge.
- Overlap seams of blankets at least six (6) inches.
- Turf reinforcement mats are a three dimensional matrix of interwoven layers of polypropylene, nylon, and polyvinyl chloride netting. They allow for soil filling and retention as well as aid in the enhancement of vegetative root and stem development. They are inappropriate where hydrology is inadequate for vegetation establishment.
- Turf reinforcement mats are not biodegradable. They have high shear strengths, are resistant to ultraviolet light, and are inert to the chemicals in soils.
- Straw, coconut, straw/coconut, or Excelsior blankets are appropriate as erosion control blankets.
- Remove all rocks, and debris from the site before installing erosion control mats to allow for good soil contact.
- Generally apply seed under erosion control blankets.
- All stakes shall of adequate length for soil type and application.

Steps to install erosion control blankets on slopes:

- At the top of the slope, install a trench 6 inches deep by 6 inches wide to anchor the blanket and then backfill the trench.
- Install along flow line of slope and unroll the blanket (downslope).
- Overlap parallel rolls by at minimum six (6) inches and stake every 3 feet or as appropriate for site and blanket type.
- Keep the blankets in direct contact with the soil. Do not stretch them.

Rolled Erosion Control Products

EC-6

To anchor the blanket, install stakes (as recommended on page 8-15) or staples:

- Steep slopes (2H:1V and steeper) – minimum of 2 stakes /yd²
- Moderate slopes (2H:1V and flatter) – 1½ stakes /yd²
- Gentle slopes require a minimum of 1 stake /yd²

Steps to install erosion control blankets in channels:

- Anchor trench shall be a minimum of 12 inches deep and 6 inches wide across the channel at the top end of the project area.
- Backfill trench and compact.
- The precise installation method will vary with channel dimension, velocities, material etc. and may be parallel or perpendicular to the flow line.
- Make sure if perpendicular that installation begins at the end of the channel, and install in a shingle pattern with proper overlap up the channel with a key trench at the top of the installation.

Inspection and Maintenance:

- Inspect blankets after installation and periodically during construction activities.
- Inspect blankets and mats before and after significant storm events, for erosion and undermining.
- Repair damages and failures immediately.
- Repair the slope or channel before reinstalling blankets if washouts or degradation occur.

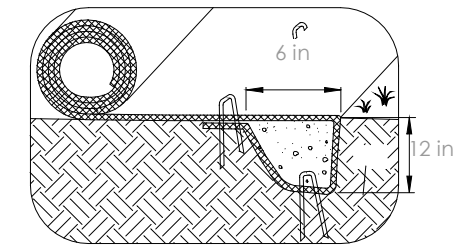

INITIAL CHANNEL ANCHOR TRENCH
NTS

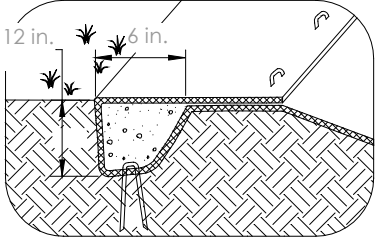

TERMINAL SLOPE AND CHANNEL ANCHOR TRENCH
NTS

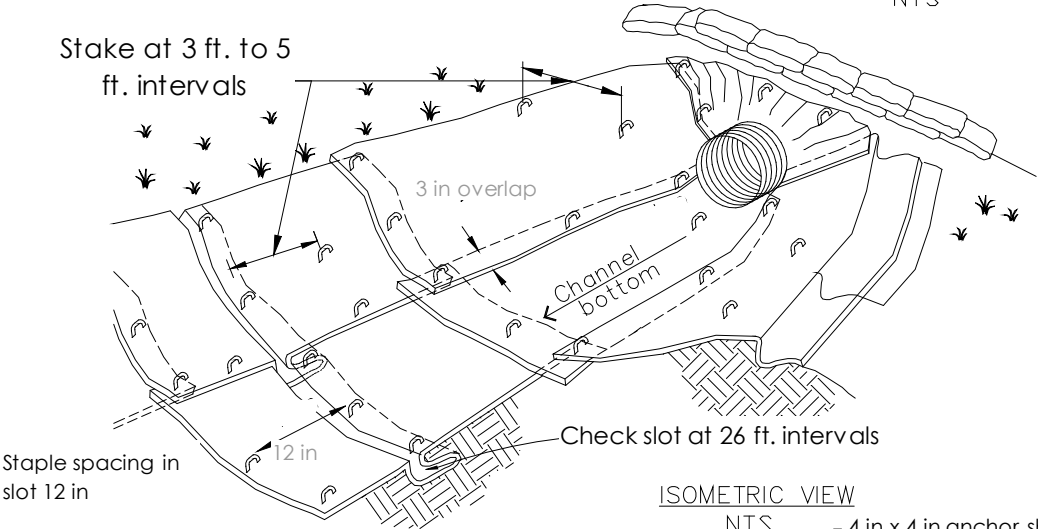

ISOMETRIC VIEW
NTS

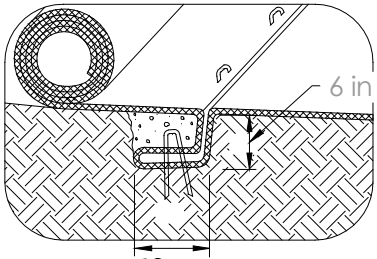

INTERMITTENT CHECK SLOT
NTS

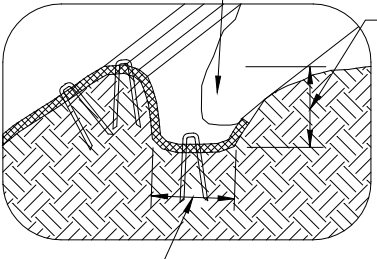

LONGITUDINAL ANCHOR TRENCH
NTS

- NOTES:
- 1. Check slots to be constructed per manufacturers specifications.
 - 2. Staking or stapling layout per manufacturers specifications.
 - 3. Install per manufacturer's recommendations

Rolled Erosion Control Products

EC-6

Graphics used with permission of Caltrans.

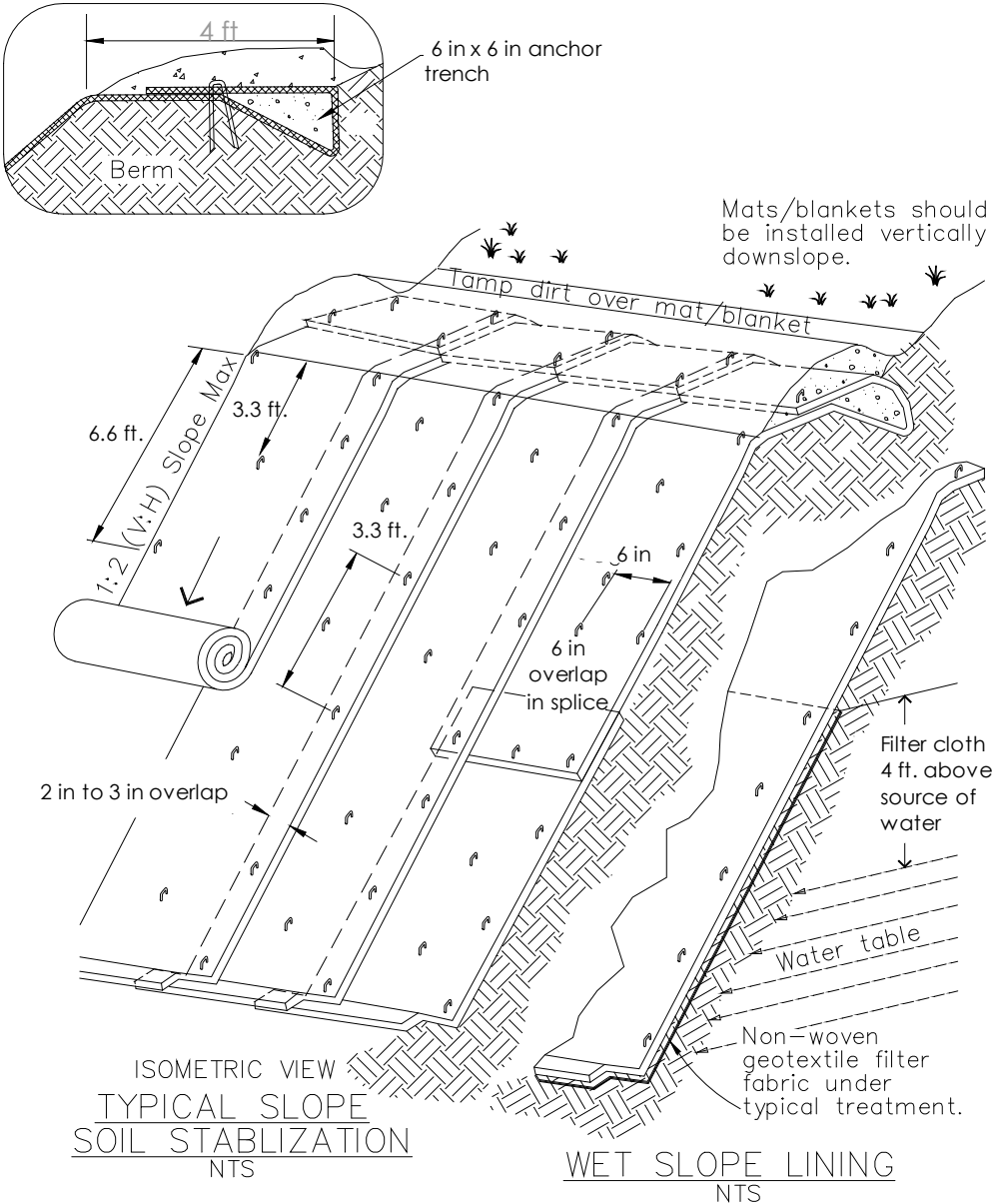

NOTES:

1. Slope surface shall be free of rocks, clods, sticks and grass. Mats/blankets shall have good soil contact.
2. Lay blankets loosely and stake or staple to maintain direct contact with the soil. Do not stretch.
3. Install per manufacturer's recommendations

Rolled Erosion Control Products

EC-6

Graphics used with permission of Caltrans.

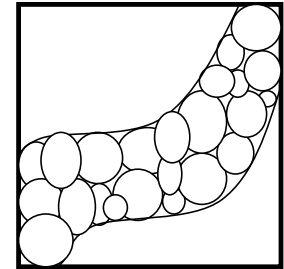
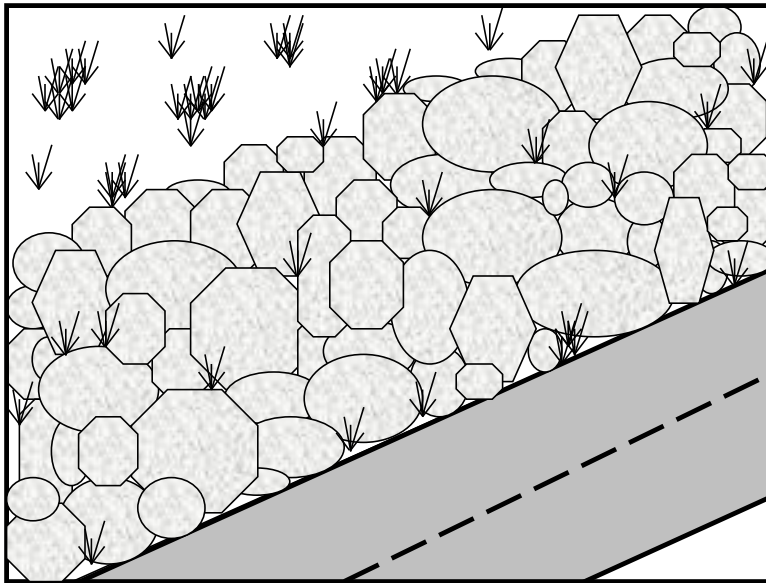

Map Symbol

Graphics produced by Kennedy/Jenks Consultants

Purpose: To stabilize and protect soil from erosion.

Applications:

- Used on cut-and-fill slopes, channel side slopes, channel bottoms, inlets and outlets of culverts and slope drains, and streambanks.

Limitations:

- Riprap is not allowed for use as an erosion or sediment control on disturbed slopes within the City of Sparks.
- Implement measures to minimize erosion and excess turbidity in flowing streams during construction.

Standards and Specifications:

- Use a well-graded mixture of rock sizes depending on project objective(s) and site conditions.
- Use durable stone that won't quickly decompose from freeze/thaw cycles (i.e. granite).
- Construct riprap layers twice as deep as the maximum stone diameter.
- Consider use of filter cloth material or a layer of gravel as a filter between the riprap and the underlying soil surface in areas of high velocities.
- Extend riprap as high as the maximum flow depth in channels or streams (minimum of 4 feet) or to a height where vegetation will be satisfactory to control erosion.
- Use in conjunction with salvaged native material wherever feasible and appropriate (cut and fill slopes).
- On curves, extend riprap through the curve to five times the upstream and downstream curve endpoints.

Riprap

EC-7

Inspection and Maintenance:

- Inspect annually and after major storms.
- Repair and replace as needed.
- Keep channel clear of obstructions such as trees and sediment bars.

Revegetation

EC-8

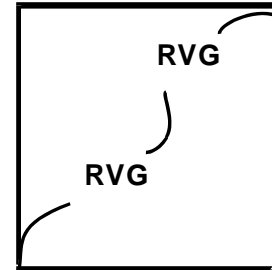
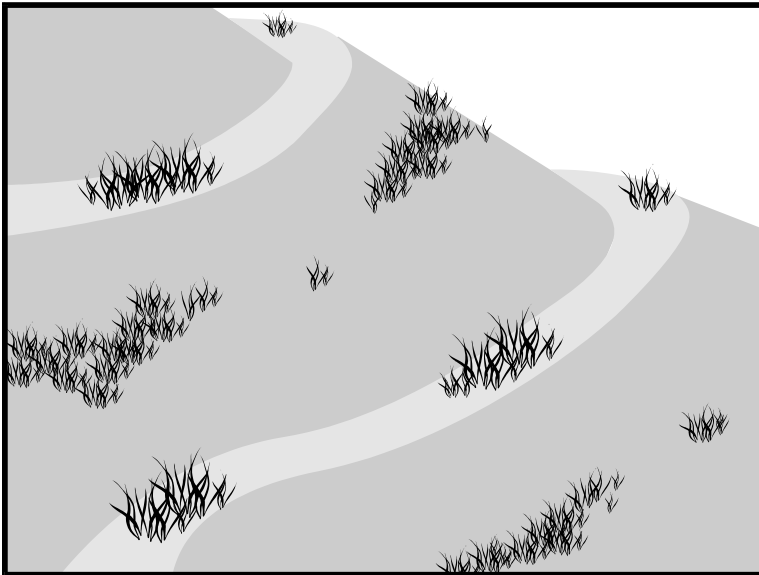

Map Symbol

Graphics used with permission of Caltrans

Purpose: To permanently stabilize soils and slopes from raindrop impact and wind erosion, conserve soil moisture, decrease runoff, increase infiltration, and to provide wildlife habitat.

Applications:

- Can be applied on slopes, adjacent to waterways, along right-of-ways, as buffer strips and landscape corridors, on stream banks and in cut and fill areas.

Limitations:

- Irrigation during dry weather may be desirable for specific projects, but is generally not recommended.
- Additional erosion control methods may be required since 3-5 years is generally needed to establish adequate cover.
- Sod is almost always inappropriate for erosion control. Most species of commercially available sod require permanent irrigation.

Standards and Specifications:

- With the exception of frozen ground conditions, permanent revegetation must be seeded no later than 14 days after final grading, unless final grading takes place outside the seeding or planting window. In that case temporary erosion control is required until seeding can occur.
- Seeding in northern Nevada should take place between September 15 and February 15.

Revegetation

EC-8

- Consider climate, soils, and topography when choosing the appropriate vegetation and seed mixes for installation. Develop seed mixes based on site-specific conditions. Soil testing is recommended and should include soil biology.
- Hydroseeding is a cost effective method of applying seed mixes.
- Use a variety of seed species, including grasses, forbs, and shrubs, when the objective is to re-establish self-sustaining native and adapted species that do not require irrigation.
- All seeding rates must be based on Pure Live Seed ratios.
- In general, crested wheatgrass should not be the dominant species in the seed mix unless used in fire-prone areas in the urban interface.
- Increase revegetation success by roughening soils (EC-2) prior to seeding then applying mulch (EC-3) with a tackifier.
- Do not use fertilizers. Some soil amendments may be appropriate, especially where no topsoil is available (or for containerized plants).
- Consider use of soil inoculants in highly disturbed soils.
- Final stabilization requires that perennial vegetation cover consist of 70 percent of the native background cover, determined from a reference site or pre-project conditions.

Maintenance:

- Irrigation is discouraged, but may be desired for more rapid seed establishment. Drip irrigation is preferred for containerized plants.
- Examine seeded areas for failures. Amend, reseed, and mulch as necessary. Conduct soil testing to determine if soil inoculants or amendments are necessary.

Suggested Northern Nevada Seed for Revegetation

Botanical Name	Common Name/Variety	Comments
<i>Achillea millefolium</i>	Yarrow	Upland
<i>Achnatherum hymenoides</i>	Indian ricegrass	Upland
<i>Achnatherum speciosa</i>	Desert needlegrass	Upland
<i>Agropyron cristatum</i>	Crested wheatgrass, "Fairway", "Ephraim"	Upland
<i>Agropyron elongatum</i>	Tall wheatgrass	Wetland
<i>Agropyron X Triticum</i>	Sterile wheat hybrid, "Escort"	Upland (nurse crop)
<i>Agropyron fragile ssp. sibericum</i>	Siberian wheatgrass "P-27"	Upland
<i>Artemisia tridentata ssp vaseyana</i>	Mountain big sagebrush	Upland

Revegetation

EC-8

Botanical Name	Common Name/Variety	Comments
<i>Artemisia tridentata</i> ssp <i>tridentata</i>	Big sagebrush	Riparian
<i>Artemisia tridentata</i> ssp <i>wyomingensis</i>	Wyoming sagebrush	Upland
<i>Atriplex canescens</i>	Four-wing saltbrush	Upland (salt affected)
<i>Atriplex confertifolia</i>	Shadscale	Upland (salt affected)
<i>Atriplex lentiformis</i>	Quail bush	Upland (salt affected)
<i>Chrysothamnus nauseosus</i>	Rabbitbrush	Upland
<i>Chrysothamnus viscidiflorus</i>	Sticky rabbitbrush	Upland
<i>Cleome lutea</i>	Beeplant	Upland
<i>Distichlis stricta</i>	Inland saltgrass	Wetland (salt affected)
<i>Elymus cinereus</i>	Great Basin wildrye,	Upland
<i>Elymus elymoides</i>	Squirreltail	Upland
<i>Elymus lanceolatus</i>	Streambank or thickspike wheatgrass	Upland, Wetland
<i>Elymus trachycaulus</i>	Slender wheatgrass	Upland
<i>Ephedra viridis</i>	Mormon tea	Upland
<i>Eriogonum umbellatum</i>	Sulphur flower	Upland
<i>Eriogonum wrightii</i>	Wright's buckwheat	Upland
<i>Festuca longifolia</i>	<i>Hard fescue</i>	<i>Upland</i>
<i>Festuca ovina</i>	<i>Sheep fesc</i>	<i>Upland</i>
<i>Gaillardia aristata</i>	<i>Indian blanket flower</i>	<i>Upland (irrigated)</i>
<i>Grayia spinosa</i>	<i>Spiny hopsage</i>	<i>Upland (salt affected)</i>
<i>Gutierrezia sarothrae</i>	Snakeweed	Upland
<i>Helianthus annuus</i>	Sunflower	Upland
<i>Kochia prostrata</i>	Prostrate summer cypress	Upland
<i>Kraschenekovia lanata</i>	Winterfat	Upland
<i>Leymus triticoides</i>	Creeping wildrye,	Wetland
<i>Linum lewisii</i>	Lewis flax,	Upland
<i>Lolium multiflorum</i>	Annual ryegrass	Upland
<i>Lupinus argenteus</i>	Silverleaf lupine	Upland
<i>Penstemon palmeri</i>	Palmer penstemon	Upland
<i>Poa secunda</i>	Sandberg bluegrass	Upland
<i>Prunus andersonii</i>	Desert peach	Upland
<i>Psuedoroegneria spicata</i>	Bluebunch wheatgrass	Upland
<i>Puccinellia lemmonii</i>	Alkali grass	Wetland (salt affected)
<i>Purshia tridentata</i>	Antelope bitterbrush	Upland

Revegetation

EC-8

Botanical Name	Common Name/Variety	Comments
<i>Sarcobatus vermiculatus</i>	Greasewood	Wetland (salt affected)
<i>Sphaeralcea species</i>	Globemallow	Upland
<i>Sporobolus airoides</i>	Sand dropseed	Upland
<i>Sporobolus cryptandrus</i>	Alkali sacaton	Wetland (salt affected)

*All seeding rates must be based on Pure Live Seed

Source: Western Botanical Services, Inc.

Note: Recipes are based on site soil conditions in the Truckee Meadows are provided in Appendix E.

Section 9: Sediment Control Best Management Practices

This section presents the temporary measures that can be used to control sediment transport and reduce or eliminate sediment discharges offsite and into receiving waters.

- Linear sediment control BMPs such as Fiber Rolls (SC-1), Brush and Rock Filters (SC-2), Sand & Gravel Bag Barriers (SC-3), Gravel Filter Berms (SC-4) and Silt Fences (SC-5) do not control erosion, but can reduce erosion by reducing flow velocities and diverting flows away from erodible soils. They are intended to intercept and slow or detain storm water runoff and allow sediment to settle and be trapped.
- Temporary Sediment Traps (SC-6) and Sediment Retention Basins (SC-7) also capture and detain runoff and allow sediment to settle.
- Other sediment control BMPs such as Construction Site Entrances and Exits (SC-8), Construction Exit Tire Washes (SC-9) and Stabilized Construction Roadways (SC-10) function to minimize the amount of sediment tracked offsite by construction vehicles.

Slope length and inclination are the two most important factors controlling erosion rates. Fiber rolls and silt fences can be used to break up slope length. Fiber rolls are very flexible BMPs and can be applied along the top, face and toe of mild to steep exposed and erodible slopes to shorten slope length and spread runoff as sheet flow. Silt fences must not be placed at the top of slopes or across moderate to steep slopes with inclinations of 4H:1V or greater.

Other linear sediment control BMPs such as brush and rock filters, sand & gravel bag barriers, and gravel filter berms must be placed below the toe of slopes, and not across the face of slopes. These BMPs, as well as fiber rolls, silt fences, temporary sediment traps, and sediment retention basins must be maintained at regular intervals and the trapped sediment removed before the BMP capacity has been reduced by 50 percent or more. For example, the sediment impounded behind a silt fence must be removed and properly disposed of before it reaches $\frac{1}{2}$ the height of the silt fence. The sediment removed must be placed where it won't wash into the storm drain system or waterways.

Synthetic Sediment Control Rolls (SC-11) have similar applications to fiber rolls. However, **synthetic sediment control rolls are temporary BMPs that must be removed once site stabilization is achieved.** Whereas fiber rolls and compost filter berms and socks are generally biodegradable and can be left in place to assist with permanent site erosion and sediment control.

Table 9-1: Sediment Control Best Management Practices

BMP#	BMP Name	Temporary	Permanent
SC-1	Fiber Rolls	T	P
SC-2	Brush and Rock Filters	T	
SC-3	Sand & Gravel Bag Barriers	T	
SC-4	Gravel Filter Berm	T	
SC-5	Silt Fences	T	
SC-6	Temporary Sediment Traps	T	
SC-7	Sediment Retention Basins	T	P
SC-8	Construction Site Entrances and Exits	T	
SC-9	Construction Exit Tire Wash	T	
SC-10	Stabilized Construction Roadway	T	
SC-11	Synthetic Sediment Control Rolls	T	

Fiber Rolls

SC-1

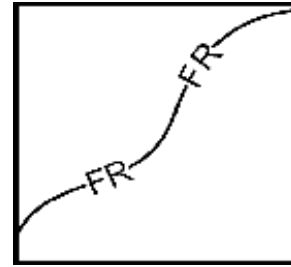
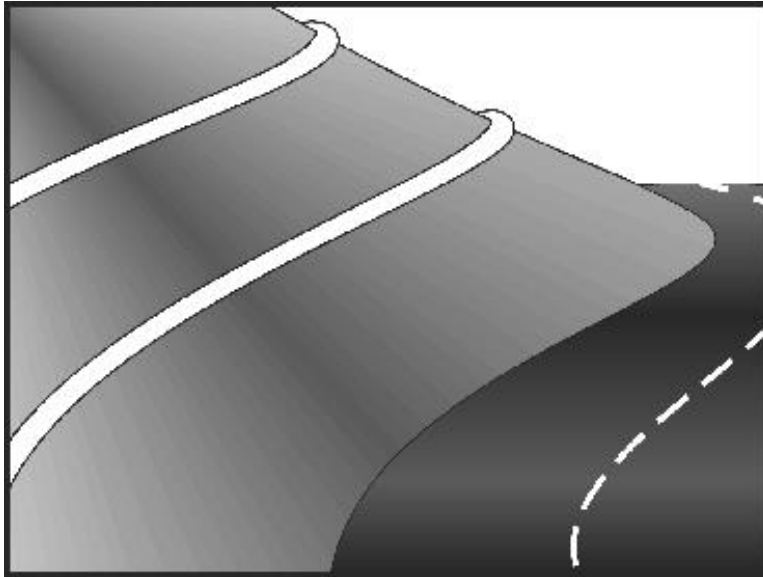

Map Symbol

Graphics used with permission of Caltrans

Purpose: Fiber rolls allow water to pass through while decreasing runoff velocity, increasing infiltration rates, and trapping sediment. Also known as sediment logs or straw wattles, they can provide temporary or permanent controls and biodegrade if made with biodegradable materials (non-plastic netting).

Applications:

- Along the top and face of slopes to reduce the slope length and to spread runoff as sheet flow.
- At grade breaks where slopes transition from shallow to steep.
- As check dams in drainage swales where flows will not exceed 1 cfs.
- Along streambanks.
- If properly anchored or weighted, to protect storm drain inlets.
- Down-slope of exposed soil areas.
- Around temporary stockpiles.
- Along the perimeter of a project.

Limitations:

- Proper siting and installation are critical to ensure effectiveness and to prevent exacerbated erosion and/or blockage of storm drain systems.
- Not to be used where surface flows are anticipated to exceed 1 cfs.
- Fiber rolls can be transported by high flows if not properly anchored.

Fiber Rolls

SC-1

- Do not use fiber rolls on slopes subject to creep, slumping of landslides. (geologic instability)
- Fiber rolls are difficult to move or remove when saturated.

Standards and Specifications:

- Fiber rolls consist of straw, aspen shavings (excelsior) or coconut fiber (coir), contained in tubular nets or tubes composed of burlap fabric.
- When placed along the face of slopes, spacing between rows of fiber rolls is determined by slope inclination and slope length (see table below).

Slope Steepness	Fiber Roll Spacing
2H:1V or steeper	10 feet or less
4H:1V to 2H:1V	15 feet or less
4H:1V or flatter	20 feet or less

- On slopes create a concave trench 30 percent of roll width on contour. Place the excavated soil on the uphill side of the roll during installation.
- Remove debris and stones from the trench before installing fiber rolls.
- Lay the fiber roll into the trench and stake through the middle of the roll , stake it on both sides of the roll at the ends, and continue to stake every 4 feet (7 stake per 25 ft. roll).
- Stakes shall have a minimum dimension of ¾ inch X ¾ inch X 24 inches.
- Install stakes through the middle of the roll, averaging at most 4 feet. on center.
- If more than one fiber roll is placed in a row, overlap the end sections. Do not leave gaps between the end sections.

Inspection and Maintenance:

- Repair and/or replace torn, split, unraveling, or slumping fiber rolls.
- Inspect fiber rolls before and after storm events. Check fiber rolls daily during prolonged rainfall events.
- Re-trench and stake down fiber rolls that are undercut by rills or gullies.
- Remove accumulated sediment when it reaches three quarters (3/4) of the barrier height unless vegetation has established, properly dispose of collected sediment or move to a vegetated area or other place at the site where it will not wash into storm drains, ditches, channels, or streams.
- Fiber rolls **should not be** removed if part of the permanent erosion control and site stabilization. If non-biodegradable and are a temporary BMP, collect and dispose of sediment accumulation, and fill and compact holes, trenches, depressions or any other ground disturbance to match the adjacent surface. Seed and mulch, or otherwise stabilize, the regarded area where the fiber rolls were removed (apply seed during fall or winter months).

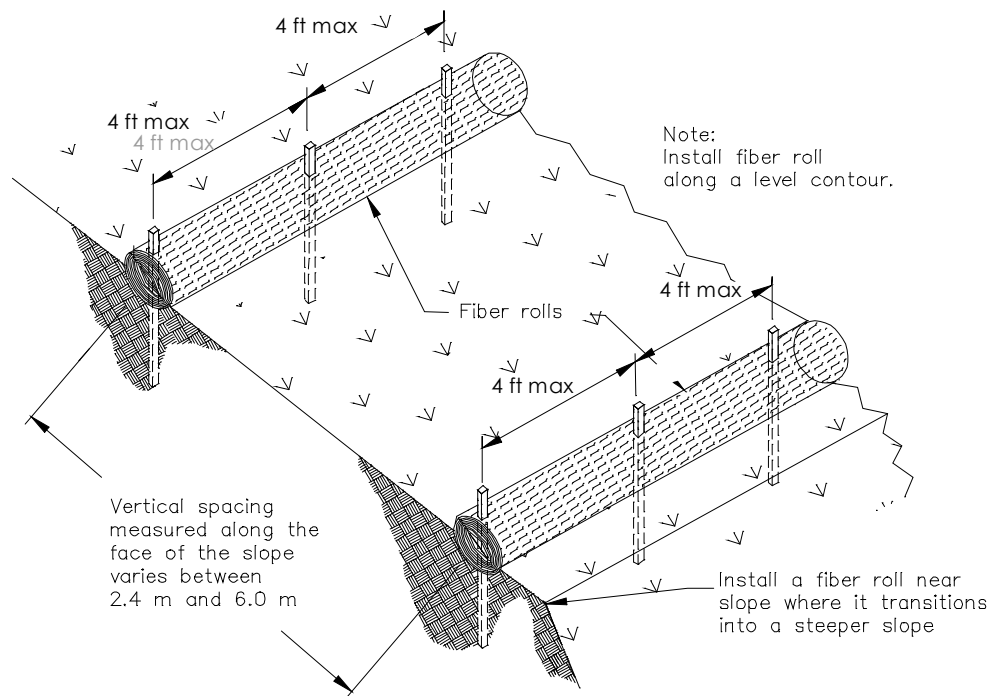

TYPICAL FIBER ROLL INSTALLATION

N.T.S.

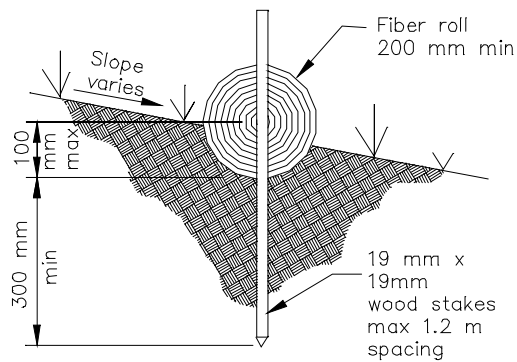

ENTRENCHMENT DETAIL

N.T.S.

Graphic adapted and used with permission of Caltrans.

Brush and Rock Filters

SC-2

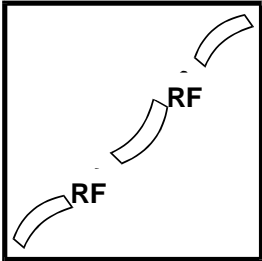
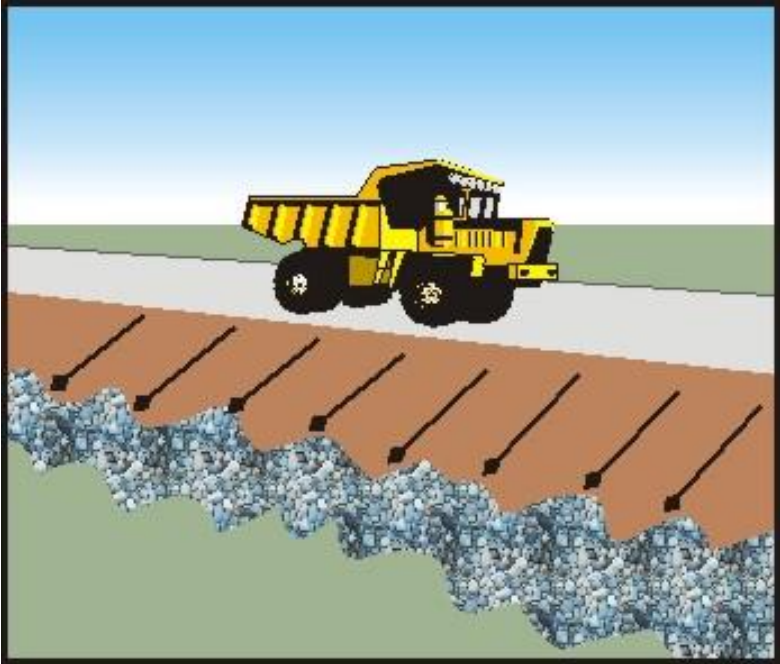

Map Symbol

Graphics produced by Kennedy/Jenks Consultants

Purpose: Runoff filters are used to temporarily detain and filter runoff, retain sediment on construction sites, and slowly release water as sheet flow to a stabilized or undisturbed area.

- Applications:**
- Along the border of disturbed areas, particularly linear projects.
 - Contributing drainage areas of less than 5 acres.
 - At the toe of slopes that are prone to sheet flow and rill erosion.
 - Can be re graded for permanent erosion control.
 - Rock filters encased in steel wire enclosures are also known as gabions.

- Limitations:**
- Not appropriate where drainage areas are greater than 5 acres.
 - Sufficient space is needed for water to pond behind the erosion control structure.
 - Rock filters are not effective for diverting runoff.
 - Not appropriate for high-velocity flow areas.

- Standards and Specifications:**
- The maximum flow through rate for a rock berm is 60 gpm/ft².
 - The minimum height of a rock berm is 18 inches from the ground surface.

Brush and Rock Filters

SC-2

- The minimum top width of a rock berm is 2 feet.
- The maximum steepness of rock berm side slopes is 2H:1V.
- Entrench rock berms a minimum of 3-4 inches into the ground.
- Use a 3 to 5 inch diameter graded rock in the construction of rock berms.
- For gabions use a minimum of 20 gauge galvanized woven wire sheath with a maximum opening of 1 inch.
- Install brush and rock filters along level contours.

Inspection and Maintenance:

- Inspect before and after each significant storm event and weekly during the wet season.
- Replace lost or dislodged rocks, brush, or filter fabric as needed.
- Remove sediment when the depth equals one-third the berm height.
- From May through October, do not allow water to pond behind brush and rock filters for more than 48 hours.
- Re-grade filter barriers upon the completion of construction activities.

Sand & Gravel Bag Barriers

SC-3

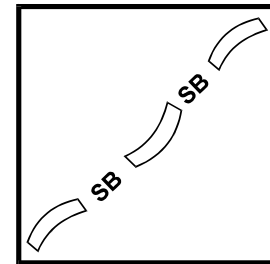
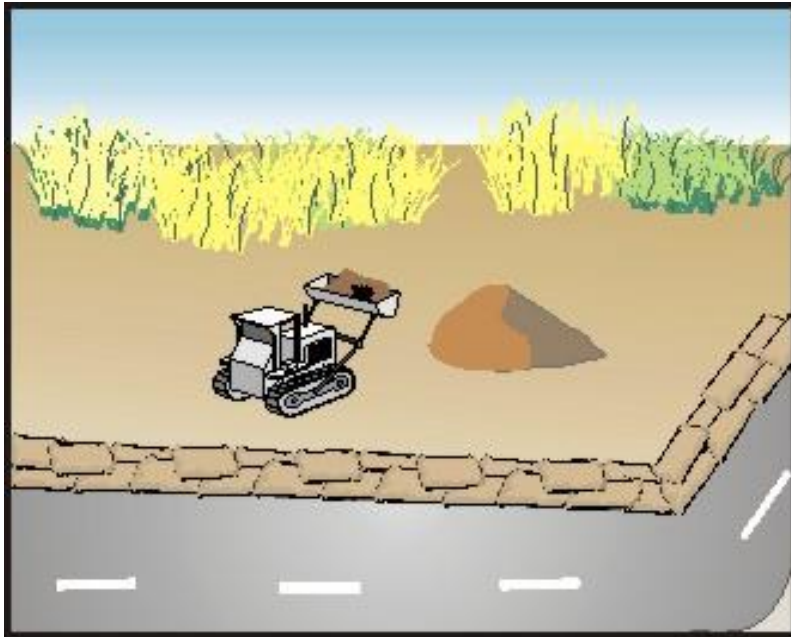

Map Symbol

Graphics produced by Kennedy/Jenks Consultants

Purpose: To detain sediment laden runoff from disturbed areas and to allow settling of sediment prior to release to storm drains, streams or other watercourses.

Applications:

Sand Bags and Gravel Bags

- Along the perimeter of a site.
- Parallel to roadways to keep sediments off pavement.
- Near the toe or at the top of slopes.
- Around stockpiled materials.
- To create a sediment basin.
- To capture and detain non-storm water discharges.

Sand Bags only

- To divert flows from storm drains, channels or watercourses.

Gravel Bags only

- To protect storm drain inlets and filter sediment from storm water.

Sand & Gravel Bag Barriers

SC-3

Limitations:

- Upstream drainage areas are limited to 5 acres or less.
- Degraded sand and gravel bags may rupture and are difficult to remove.
- Berm heights are limited to 18 inches or less.
- Installation can be labor intensive.
- Do not use gravel bag barriers to detain concentrated flows.

Standards and Specifications:

- Sand bags and gravel bags shall be constructed of woven polypropylene, polyethylene or polyamide fabric. Minimum fabric weight is 4 ounces per square yard and the mullen burst strength shall exceed 300 psi. The materials shall conform to ASTM D3786 and have ultraviolet stability in excess of 70 percent according to ASTM D4355. Burlap is not acceptable.
- Sand bags and gravel bag size shall be 18 inches x 12 inches x 6 inches.
- Fill materials shall be non-cohesive, free from clay or other deleterious materials and conform to 200.05.04 of the Standard Specifications for Public Works Construction (e.g. the "Orange Book").
- Install bags a minimum of 3 feet from the toe of the slope or from the top of the bank to allow access of construction machinery.
- Stagger bags so ends overlap.
- Biodegradable sandbags are preferred.

Inspection and Maintenance:

- Inspect before and after each rain event and weekly during the wet season.
- Reshape barrier or replace bags as needed.
- Repair any washouts or other damage caused by construction.
- Remove silt when the depth reaches one-third the barrier height.
- Remove silt and dispose of so as not to cause siltation problems.
- Prevent water from flowing around the ends of the barrier.
- From May through October, do not allow water to pond behind gravel bag barriers for more than 7 days.
- Remove bags at the end of the construction period or when the site has been stabilized.

Sand & Gravel Bag Barriers

SC-3

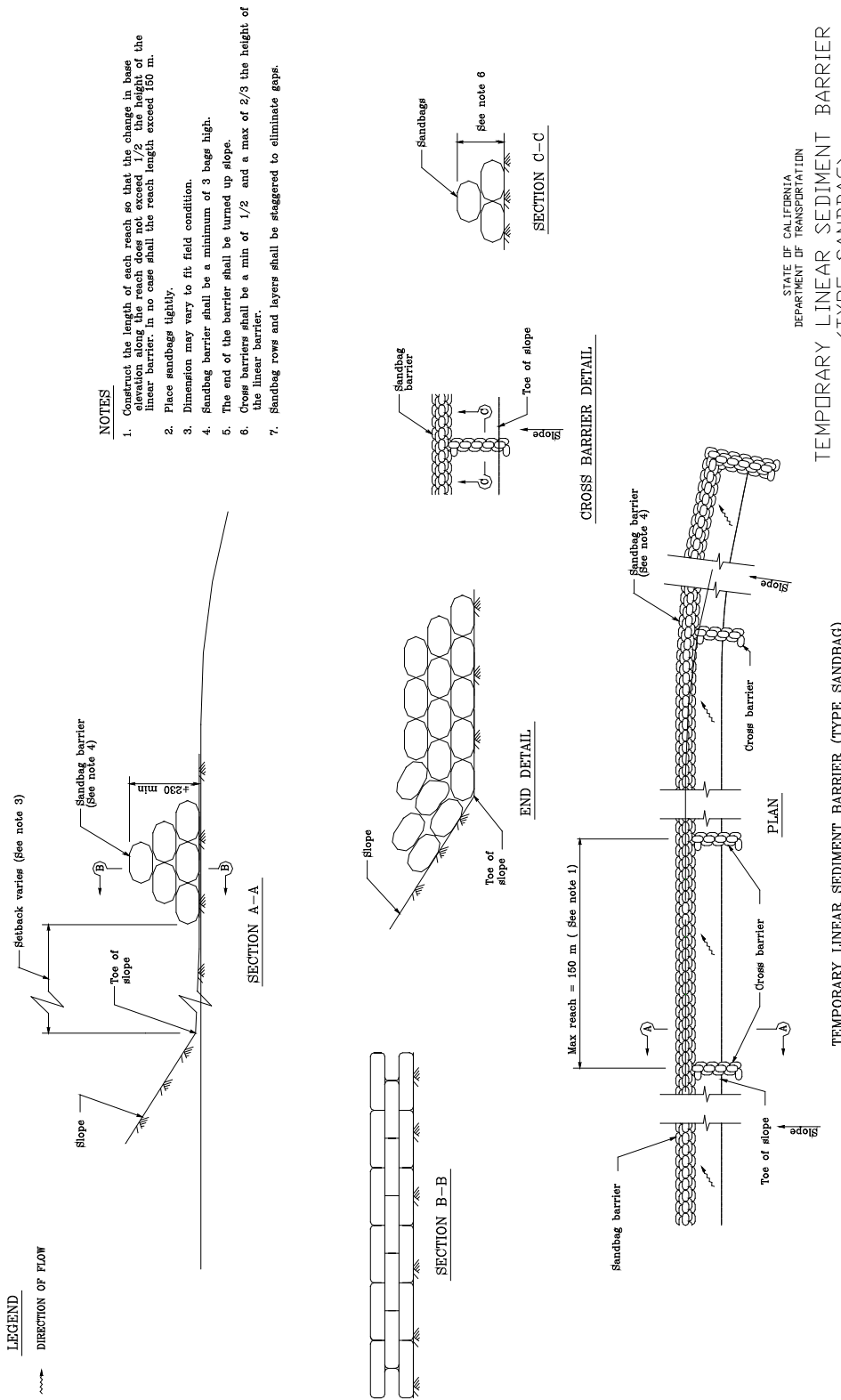

Graphic used with permission by Caltrans.

Gravel Filter Berm

SC-4

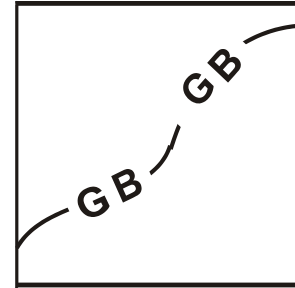
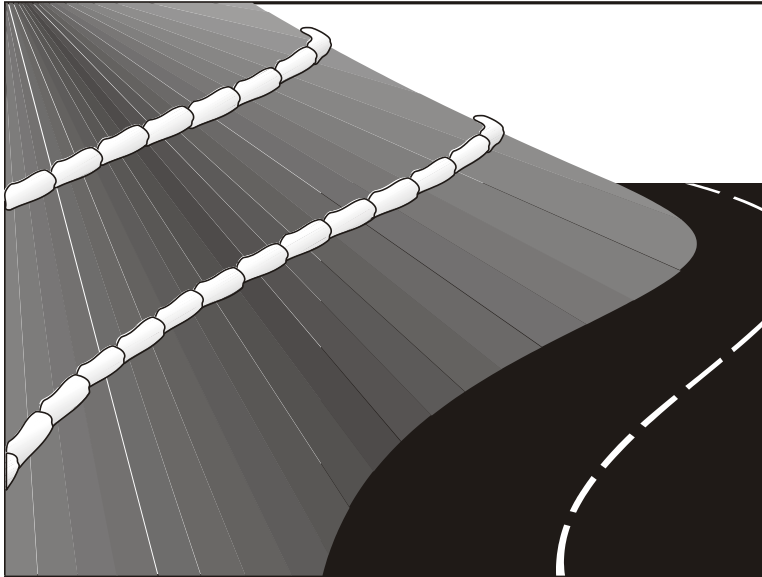

Map Symbol

Graphics used with permission of Caltrans

Purpose: To detain sediment laden runoff from disturbed areas and to allow settling of sediment prior to release to storm drains, streams or other watercourses.

Applications:

- Across slopes.
- Near the toe of slopes.
- To act as temporary check dams across construction roads or other unpaved roads when not in use.
- Around the base of stockpiled materials.

Limitations:

- Upstream drainage area limited to 5 acres or less.
- Difficult to clean up when applied to landscaped areas.
- Gravel bags will be damaged by vehicles if not moved.

Gravel Filter Berm

SC-4

Standards and Specifications:

- Rock gradation: $\frac{3}{4}$ inch to 3 inch open graded when used for sheet flow, 3 to 5 inch open graded for concentrated flows.
- Use 1 inch, galvanized hexagonal woven wire mesh constructed from 20 gage wire to anchor gravel in concentrated flows.
- Provide multiple berms in series every 300 feet on slopes less than percent, every 200 feet on slopes 5-10 percent, and every 100 feet on slopes greater than 10 percent.
- Non-traffic areas: Maximum flow rate per square foot through the berm is 60 gpm/ft², maximum height is 18 inches, top width is 24 inches, side slopes of 2H:1V or flatter.
- Traffic areas: Maximum height is 12 inches.

Inspection and Maintenance:

- Inspect monthly and after each rain event. Reshape or replace as needed.
- Repair any washouts or other damage caused by construction.
- Remove silt when the depth reaches one-third the berm height.
- Remove silt and dispose of to avoid siltation problems.
- Prevent flows around the ends of the barrier.
- From May through October, do not allow water to pond behind gravel filter berms for more than 7 days.
- Remove berms at the end of construction or when the site is stabilized or spread /rake on to site it appropriate for permanent erosion control.

Silt Fences

SC-5

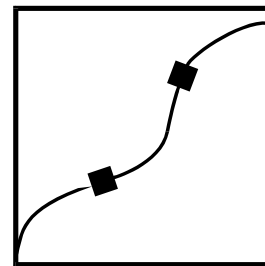
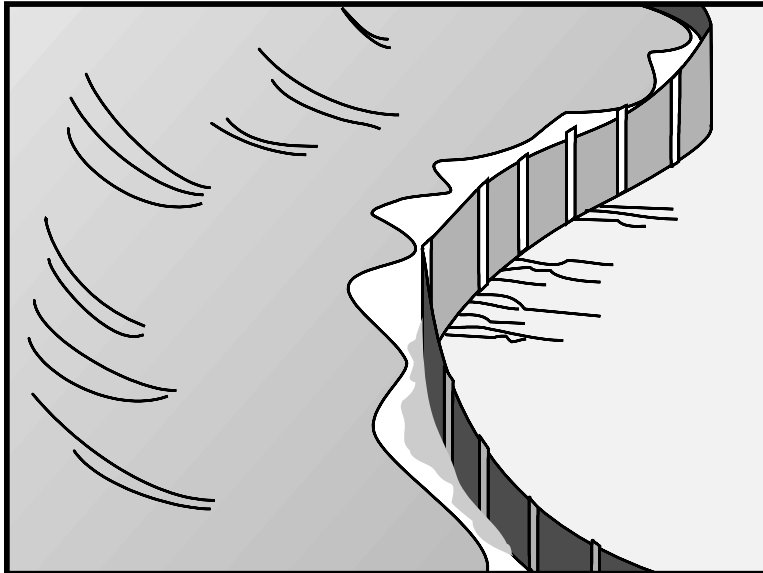

Map Symbol

Graphics used with permission of Caltrans

Purpose: To slow and detain sediment laden sheet flow from disturbed areas, which allows the settlement of sediment and reduces or prevents sediment from discharging to storm drains, streams or other watercourses.

Applications:

- Along the construction site perimeter.
- Below the toe of slopes.
- Along streambanks and channels.
- Around temporary stockpiles.

Limitations:

- Not effective unless properly installed.
- Do not use on slopes greater than 4H:1V.
- Labor-intensive maintenance may be required.
- Fencing must be removed and disposed of properly upon completion of construction.
- The key trench must be stabilized following removal.
- Often unnecessary where other methods are less intrusive.

Standards and Specifications:

- Do not install silt fences across streams, channels, or in any location where flows may be concentrated.
- Fencing must be located where waters may temporarily pond and sediments can be deposited.
- Application in environmentally sensitive areas requires additional practices.
- Install the fencing along a level contour at the toe of a slope.
- Install fencing a minimum of 3 feet from the toe of the slope or at the top of the bank.
- Limit drainage area upstream of fence to 0.25 acre per 100 feet of fence.
- Limit the length of the slope area draining to any point along the silt fence to 100 feet or less.
- Maximum length of any single run of fencing is 500 feet.
- Angle the last 8 feet of fence upslope in a “J” or “L” shape to allow for ponding.
- Silt fence material shall be woven nylon reinforced polypropylene with a built in top cord running along the top of the fabric.
- Biodegradable fences may be appropriate.
- Minimum requirements of fabric are: tensile strength (ASTM D4632) of 90 lbs, puncture rating (ASTM D4833) of 60 lbs, and mullen burst rating (ASTM D3786) of 280 psi.
- Fence posts shall be free from decay, splits, or cracks, have a minimum thickness of 2 inches, and a minimum length of 4 feet.
- Fence posts shall be installed a minimum distance of 12 inches into the ground, and have a maximum spacing of 8 feet.
- Steel fence posts may also be used.
- Areas prone to high winds will require closer spacing of fence posts.
- Fence posts shall be located on the downstream side of the fabric and mesh.
- Fabric must be stapled or wired to the posts.
- Locate a 6 inch X 6 inch trench on the upstream side of the fence. Overlap at least 6 inches of fabric into the trench. Key in the bottom of the fence as shown in Detail A. Fill the trench with tamped native soil or washed gravel.

- Silt fence fabric sizing:
 - If less than 50 percent of the soil by weight will pass through a U.S. Standard Sieve no. 200, select the equivalent opening size (EOS) to retain 85 percent of the soil. The EOS shall not be finer than U.S. Standard Sieve no. 70.
 - For all other soils, the EOS shall not be finer than U.S. Standard Sieve no. 70, except where discharge to streams or wetlands occurs. In that case, the EOS shall not be larger than U.S. Standard Sieve no. 100.
 - If 85 percent of the soil by weight is finer than U.S. Standard Sieve no. 200, then filter fabric shall not be used.

Inspection and Maintenance:

- Inspect before and after each rain event.
- Repair any damage caused by construction (undercutting of the fence, split, torn, and weathered fabrics, or slumping of the fence).
- Fabrics may have to be replaced every 5-8 months.
- Remove silt when the depth of the deposit reaches one-third the fence height.
- Remove silt and dispose of to avoid siltation problems.
- From May through October, do not allow water to pond behind silt fences for more than 7 days.
- Remove fencing at the completion of the construction project or when the site has been stabilized.
- Backfill any holes or depressions caused by the removal of the silt fence according to standard specifications.



TEMPORARY LINEAR SEDIMENT BARRIER (TYPE SILT FENCE)

NOT TO SCALE (ADAPTED FROM CALTRANS)

NOTES

1. CONSTRUCT THE LENGTH OF EACH REACH ALONG CONTOURS SO THAT THE CHANGE IN BASE ELEVATION ALONG THE REACH DOES NOT EXCEED 1/3 THE HEIGHT OF THE LINEAR BARRIER. IN NO CASE SHALL THE REACH LENGTH EXCEED 500 FEET.
2. THE LAST 8 FEET OF FENCE SHALL BE TURNED UP SLOPE.
3. STAKE DIMENSIONS ARE NOMINAL. STEEL STAKES ARE ALSO ACCEPTABLE.
4. STAKES SHALL BE SPACED AT 8 FEET MAXIMUM INTERVALS AND SHALL BE POSITIONED ON DOWNSTREAM SIDE OF FENCE.
5. STAKES TO OVERLAP AND FENCE FABRIC TO FOLD AROUND EACH STAKE ONE FULL TURN. SECURE FABRIC TO STAKE WITH AT LEAST 4 STAPLES.
6. STAKES SHALL BE DRIVEN TIGHTLY TOGETHER TO PREVENT POTENTIAL FLOW-THROUGH OF SEDIMENT AT JOINT. THE TOPS OF THE STAKES SHALL BE SECURED WITH WIRE.
7. FOR END STAKE, FENCE FABRIC SHALL BE FOLDED AROUND TWO STAKES ONE FULL TURN AND SECURED WITH AT LEAST 4 STAPLES.
8. MINIMUM 4 STAPLES PER STAKE. DIMENSIONS SHOWN ARE TYPICAL.
9. CROSS BARRIERS SHALL BE A MINIMUM OF 1/3 AND A MAXIMUM OF 1/2 THE HEIGHT OF THE LINEAR BARRIER.
10. MAINTENANCE OPENINGS SHALL BE CONSTRUCTED IN A MANNER TO ENSURE SEDIMENT REMAINS BEHIND SILT FENCE.
11. JOINING SECTIONS SHALL NOT BE PLACED AT SUMP LOCATIONS.
12. SANDBAG ROWS AND LAYERS SHALL BE OFFSET TO ELIMINATE GAPS.

LEGEND

-  TAMPED BACKFILL
-  SLOPE DIRECTION
-  DIRECTION OF FLOW

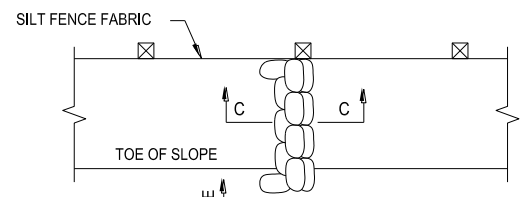

CROSS BARRIER DETAIL

(SEE NOTE 10)

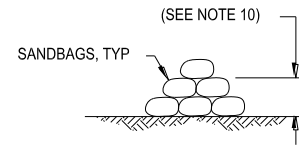

SECTION C-C

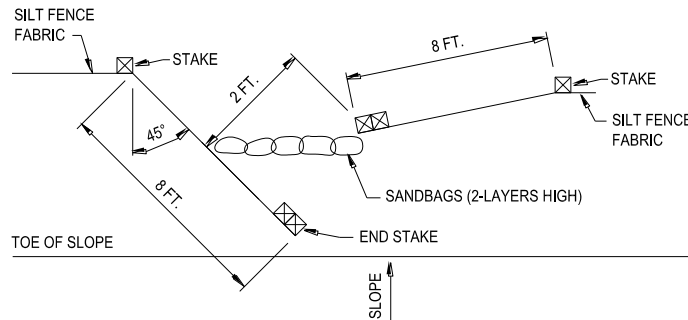

OPTIONAL MAINTENANCE OPENING DETAIL

(SEE NOTE 10)

Temporary Sediment Traps

SC-6

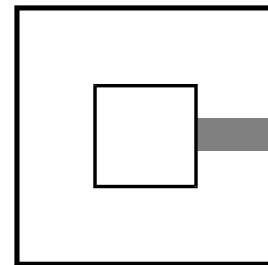
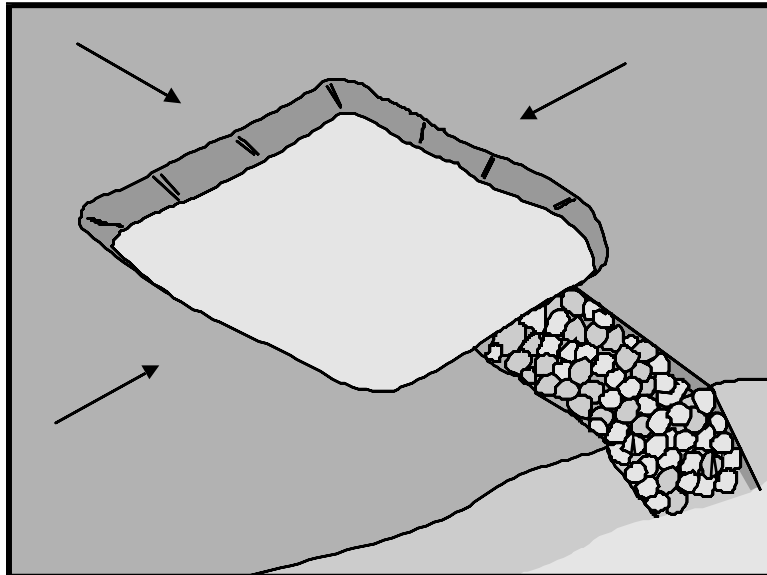

Map Symbol

Graphics used with permission of Caltrans

Purpose: To reduce sediment loading to the storm drain system by slowing concentrated runoff and allowing sediments to settle out of suspension.

Applications:

- Applies to drainage areas of 1 acre or less.
- In locations where sediment laden storm water might enter the municipal storm drain system.
- Implemented on a project-by-project basis.

Limitations:

- May require a large surface area. Size may be limited because of site constraints.
- This BMP may create a mosquito/midge habitat if water ponds longer than 48 hours from May through October.
- Traps and removes medium to large sized particles, may not remove fine-grained sediments.
- Area may be attractive and dangerous to small children and may require fencing.
- Not to be located in live streams or dry channels.
- Multiple traps are needed for large sites over 1 acre.
- Requires regular maintenance to remove sediment.

Temporary Sediment Traps

SC-6

Standards and Specifications:

- Construct the sediment trap prior to grading or stripping the site. Do not install the sediment trap in wet or muddy weather.
- Locate the trap at a low point where failure will not cause property damage, extensive erosion or loss of life.
- Fence the area to prevent unauthorized entry.
- Maintain an access for machinery.
- Clear and strip vegetation under embankments, structures and sediment traps.
- Design sediment trap with an approximate storage capacity for the 2-year, 24-hour storm, or 3,600 cubic feet per acre of total drainage area.
- The maximum height of an embankment shall be 5 feet from the original ground surface. Embankments shall be composed of engineered fill compacted to a minimum of 90 percent relative density (ASTM D1557). Side slopes shall not exceed 3H:1V.
- The maximum depth of sediment in the trap is 1 foot or one-third the trap volume.
- Size the outlet to allow passage of the 2-year, 24-hour storm peak flow. The outlet shall be stabilized with crushed rock or gabions to prevent erosion.
- Locate the spillway 1.5 feet or more below the top of the dike.

Inspection and Maintenance:

- Inspect before and after each rain event. Daily inspections are necessary during extended and intense storms.
- Repair any damages caused by construction or erosion.
- Inspect banks of the sediment trap for seepage or damage.
- Remove silts when the depths of the sediment deposits reach one-third the trap volume. Dispose of silt properly, out of the drainage path.
- Check outlet structure and spillway for damage or obstructions. Repair as needed.
- From May through October, do not allow water to pond in sediment traps for more than 7 days.
- Fill in temporary sediment basins when construction activities have ceased and final site stabilization has been established.

Temporary Sediment Traps

SC-6

NOTE:
Size spillway to convey
peak design flow.

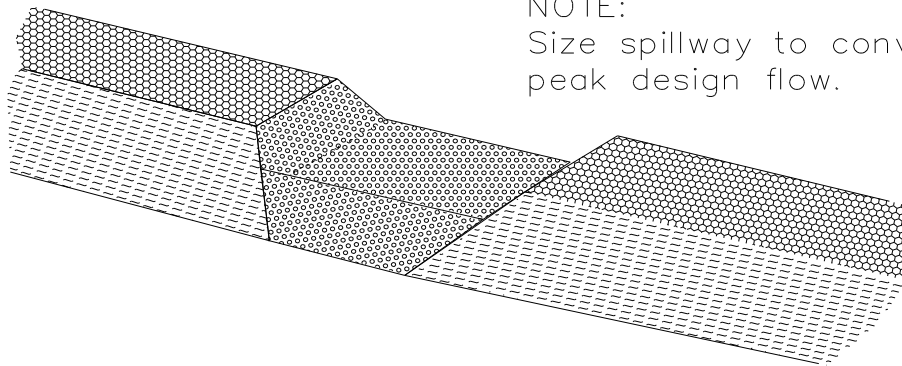

TYPICAL OPEN SPILLWAY

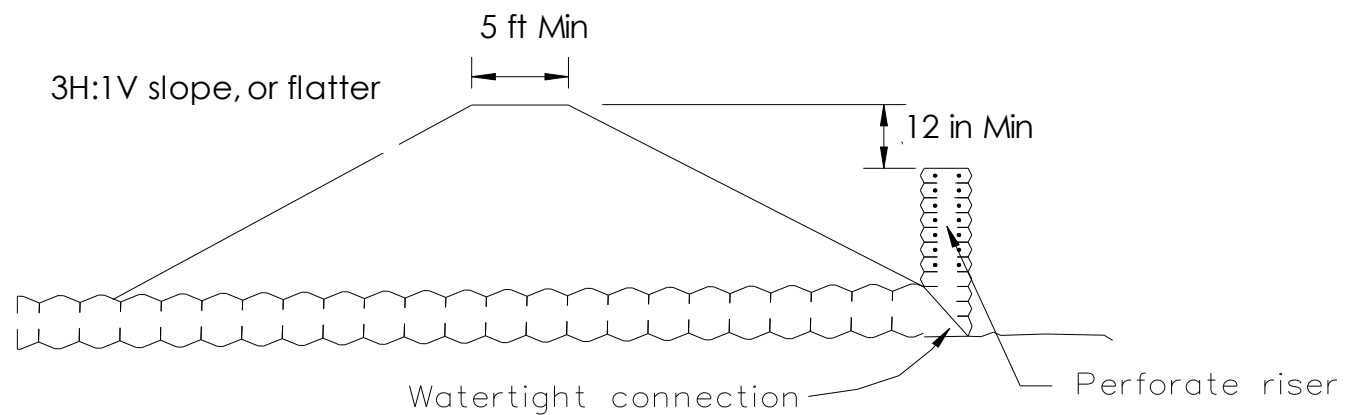
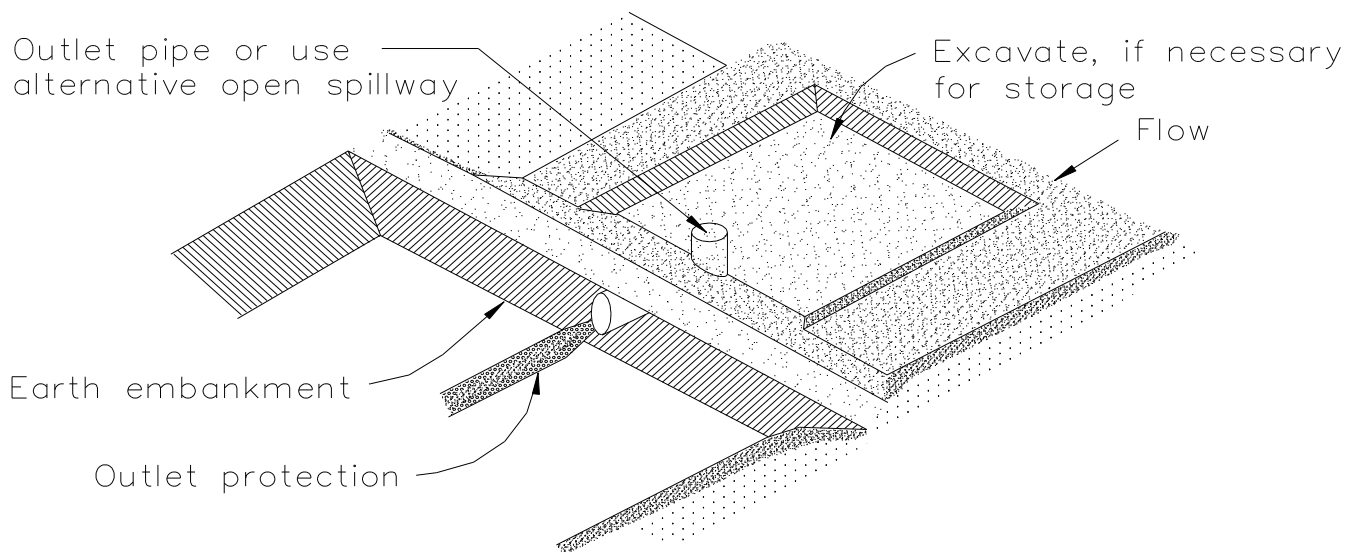

EMBANKMENT SECTION THRU RISER

TYPICAL SEDIMENT TRAP
NOT TO SCALE

Graphic used with permission of Caltrans.

Sediment Retention Basins

SC-7

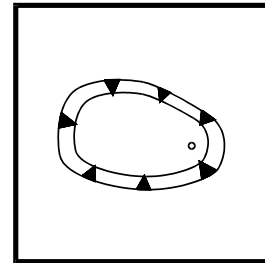
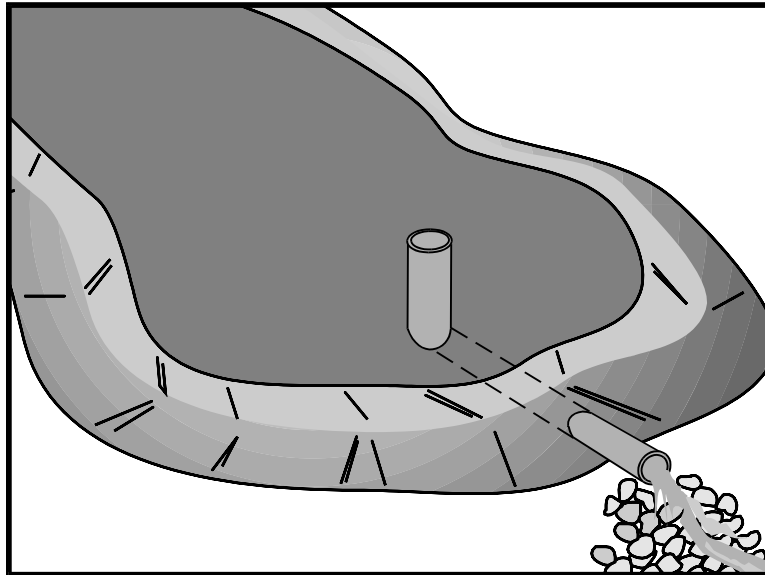

Map Symbol

Graphics used with permission of Caltrans

Purpose: To detain sediment-laden flows and allow for settling of suspended sediments prior to discharge to storm drains, streams or other watercourses. These devices can be constructed as temporary controls that will be abandoned prior to the completion of site development or as permanent flood control and storm water quality enhancement structures.

Applications:

- Construction sites with disturbed areas during the wet season.
- At outlets of disturbed areas of 1 to 20 acres.
- Reduces the potential of sediment-laden storm water from entering streams, watercourses or the municipal storm drain systems.
- Intended for surface water only. Unless permitted otherwise, do not discharge groundwater from dewatering operations into sediment a retention basin.

Limitations:

- Must be designed by a Nevada Registered Professional Engineer.
- Must use in conjunction with other methods to limit sediment.
- For temporary basins, maximum drainage area is 20 acres.
- Requires a large surface area to construct. Size may be limited because of site constraints.
- Site can be attractive and dangerous to small children and may require fencing

- Not to be located in live streams or dry channels.
- From May through October, may pose a mosquito/midge problem if water pools longer than 48 hours.
- Multiple basins may be needed for large sites over 20 acres.
- Requires regular maintenance to remove accumulated sediments.

Standards and Specifications:

- Permanent sediment retention basins shall be designed to local design standards.
- A Nevada Registered Professional Engineer must design and stamp all sediment retention basin plans.
- Design and construct basin prior to grading or stripping the site.
- The size of the basin can be reduced by limiting the contributing area to only runoff from the disturbed soil areas if temporary controls are used to divert runoff from upstream undisturbed or stabilized areas away from the drainage area of the sediment retention basin.
- Construct basin prior to the onset of the rainy/wet season.
- Locate the trap at a low point where failure will not cause property damage, extensive erosion or loss of life.
- Maintain an access for maintenance and equipment vehicles.
- Clear and strip vegetation from areas where embankments, structures and sediment traps will be installed.
- Capacity of temporary sediment retention basins shall be designed to detain at a minimum, the calculated volume of runoff from the 2-year, 24-hour storm or 3,600 cubic feet of storage per acre of drainage area.
- See Section 5.4 regarding sizing permanent sediment retention basins.
- Use a forebay located upstream of the basin to trap larger particles and dissipate the energy of incoming flows.
- Outlet shall consist of a perforated riser pipe with perforations extending to ground level such that the basin completely drains over time.
- Design the perforations in the outlet to provide a minimum 24-hour drain time. Drain times up to 72 hours will increase sediment removal efficiencies.
- Locate the inlet and outlet to maximize the travel time. The length of the basin shall be more than twice the width of the basin. The length shall be determined by measuring the distance between the inlet and the outlet. If this ratio cannot be met, silt fence baffles can be added to increase the flow length.
- Each basin must have an emergency overflow spillway designed to local drainage design standards.

Sediment Retention Basins

SC-7

- Protect outlets, inlets and spillways with non-erodible riprap.
- Above grade embankments shall be composed of compacted fill designed to local drainage design standards. Side slopes shall not be steeper than 3H:1V.
- Fence the area to prevent unauthorized entry where necessary.
- Remove sediments when the thickness of the deposit is 1 foot or one-third the basin volume or becomes vegetated.
- If intended to also provide post-construction storm water treatment, design per the standards presented in the latest version of the Truckee Meadows Structural Controls Design & LID Manual.

Inspection and Maintenance:

- Inspect before and after each rain event and weekly during the wet season.
- Perform daily inspections during an extended precipitation event.
- Inspect banks for seepage or damage.
- Repair any damages caused by construction or erosion.
- Check outlet structure and spillway for damages or obstructions. Repair as needed.
- Monitor inlet and outlet to determine effectiveness. Make corrections to the basin if it is not performing properly.
- Remove silt when the depth reaches one-third the basin volume and becomes vegetated.
- Remove silt and dispose of to avoid siltation problems.
- Fill in temporary basins once construction activities are complete and final stabilization has been established.
- From May through October, do not allow water to pond in sediment retention basins for more than 48 hours.

Sediment Retention Basins

SC-7

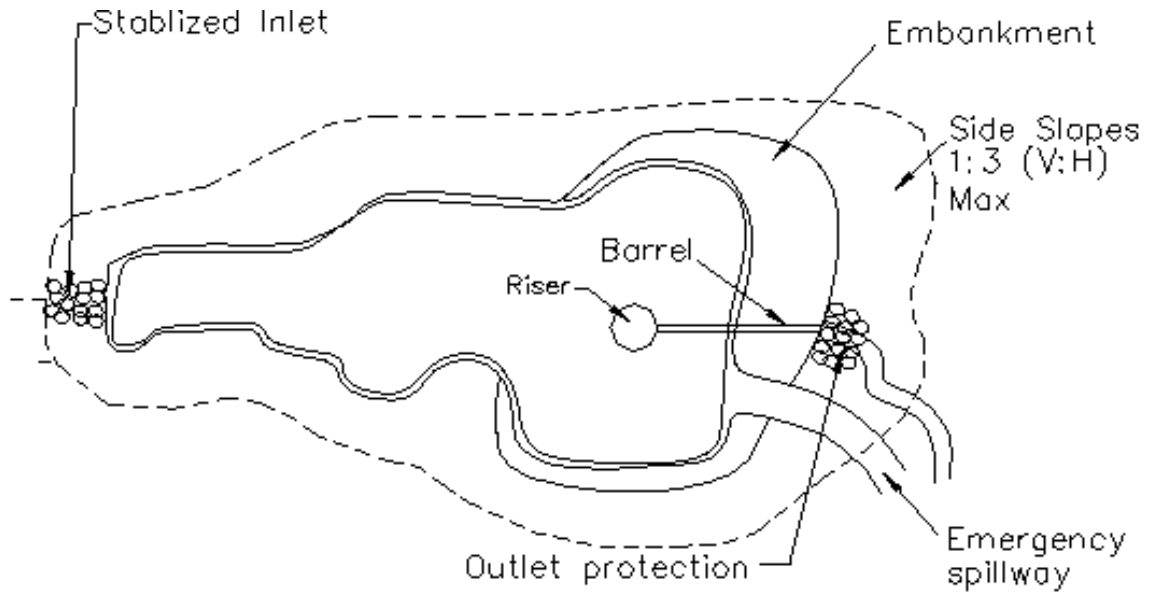

Riser encased in a gravel jacket. Perforations to base of sediment basin.

TOP VIEW

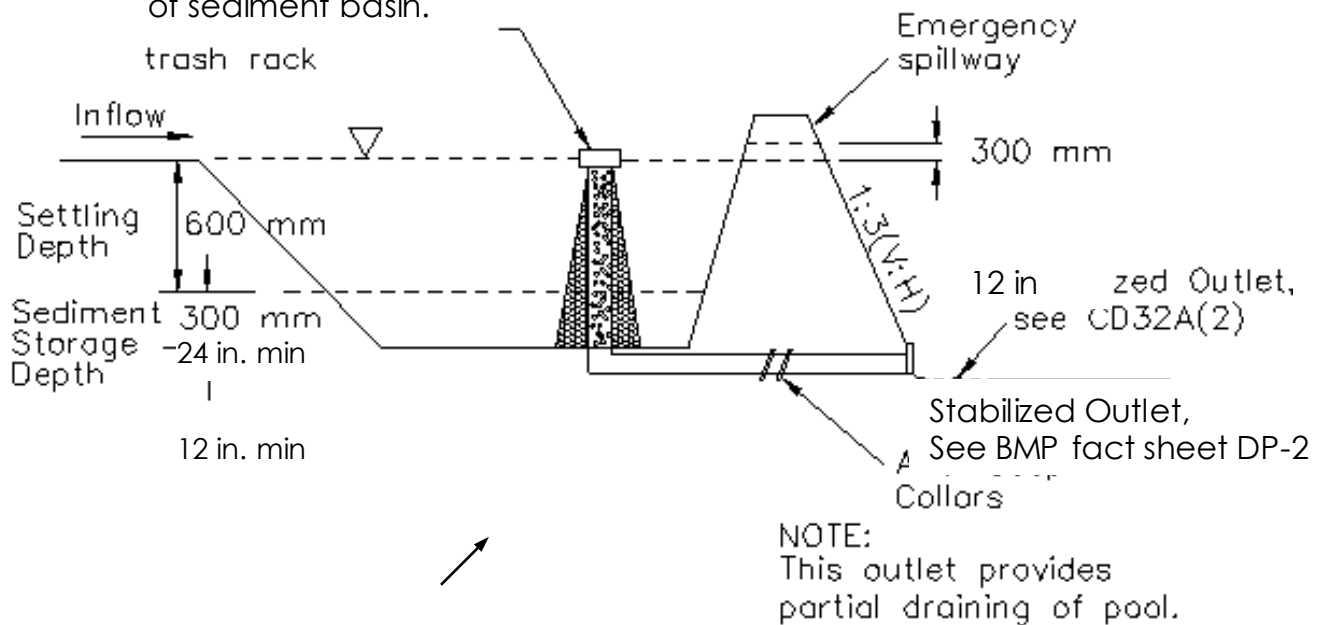

TYPICAL TEMPORARY SEDIMENT BASIN – OUTLET #1
NOT TO SCALE

Sediment Retention Basins

SC-7

Graphic used with permission of Caltrans.

Freeboard 12 in Min

12 in

Sediment Retention Basins

SC-7

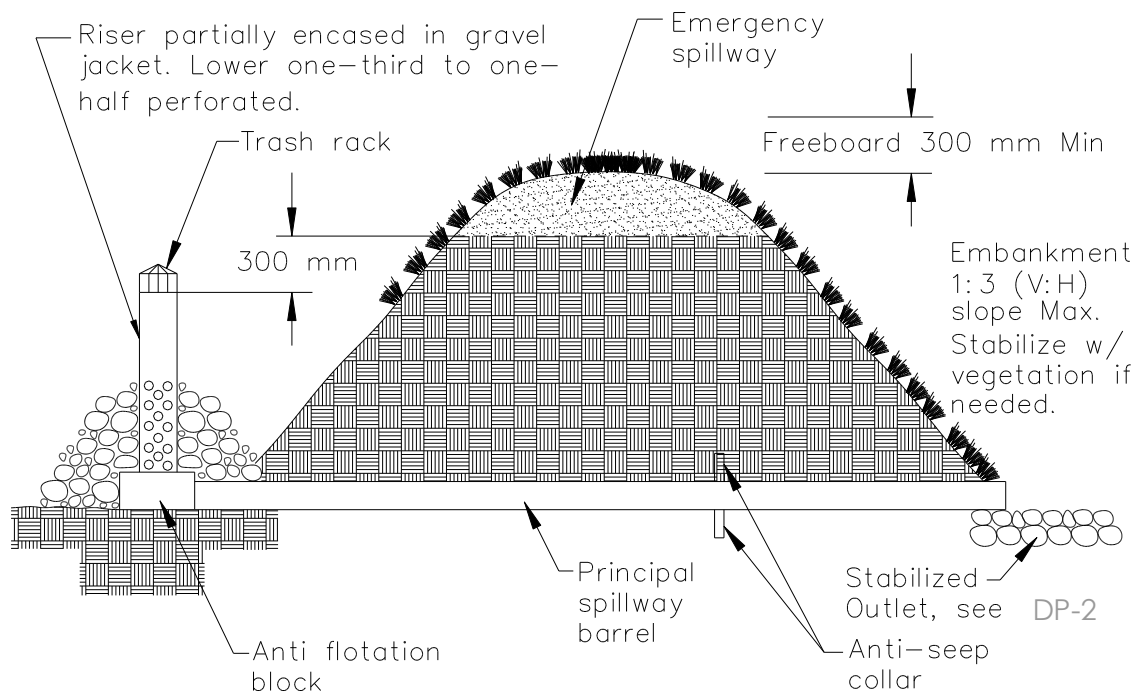

NOTE:
This outlet provides complete draining of pool.

TYPICAL TEMPORARY SEDIMENT BASIN – OUTLET #2
NOT TO SCALE

Graphic used with permission of Caltrans.

Construction Site Entrances & Exits SC-8

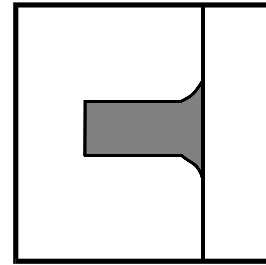
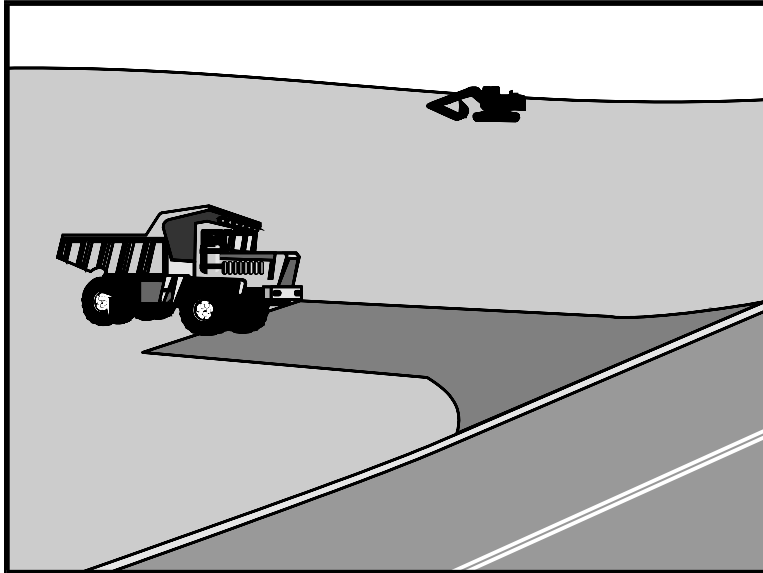

Map Symbol

Graphics used with permission of Caltrans

Purpose: To limit the tracking of mud and dirt onto public roads by construction vehicles and to limit the spread of air borne dust.

Applications:

- On construction sites where tracking dirt onto public roads is a potential problem.
- Outlets from disturbed areas.
- Near water crossings.
- Where soil conditions may cause sediments to adhere to vehicle tires.
- To control dust in trafficked areas.
- Most effective when used in conjunction with wash stations.

Limitations:

- Site conditions and layout will determine the design.
- Can be expensive to install and maintain.

Standards and Specifications:

- Follow all applicable District Health dust control standards.
- Grade the exits and entrances to prevent runoff from leaving the site.
- Include sediment traps in the design of stabilized entrances and exits. Maintain the sediment traps so that there is enough space for the sediment to settle out.

- Design entrances and exits for the heaviest vehicle using the site.
- Entrance and exits can be constructed of aggregate concrete or asphaltic concrete based on-site conditions and longevity.
- The construction site access shall be constructed of 3-6 inch washed, well-graded gravels or crushed rock. A minimum thickness of 12 inches shall be applied. However, the type of material and total depth of the aggregate should be determined by a soils engineer.
- Do not use geotextiles as linings.
- Minimum entrance or exit length is 50 feet.
- Minimum entrance or exit width is 10 feet.
- Provide turning radiuses where entrances or exits intersect a public way.
- Provide stop signs or other warning signs prior to leaving the site.

Inspection and Maintenance:

- Perform routine inspections and repair as needed.
- Require all vehicle traffic to enter and exit at these locations only.
- Service sediment traps regularly.
- Sediments deposited on paved roadways shall be removed daily and disposed of properly.
- All temporary roadway ditches shall be kept clear of sediment and debris and graded to prevent ponding.
- Fence must be installed at edges of BMP to prevent trucks driving around the BMP, and kept in close proximity to BMP at all times.

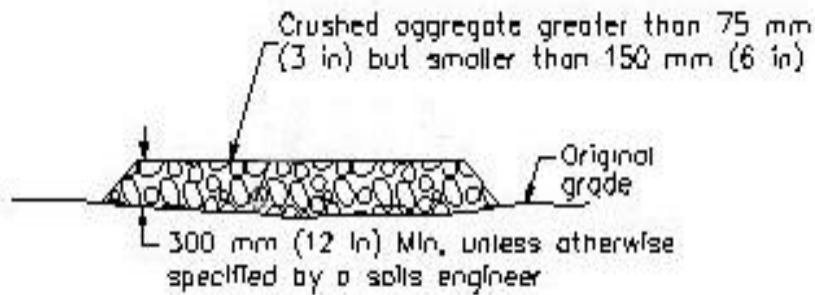

SECTION B-B
NTS

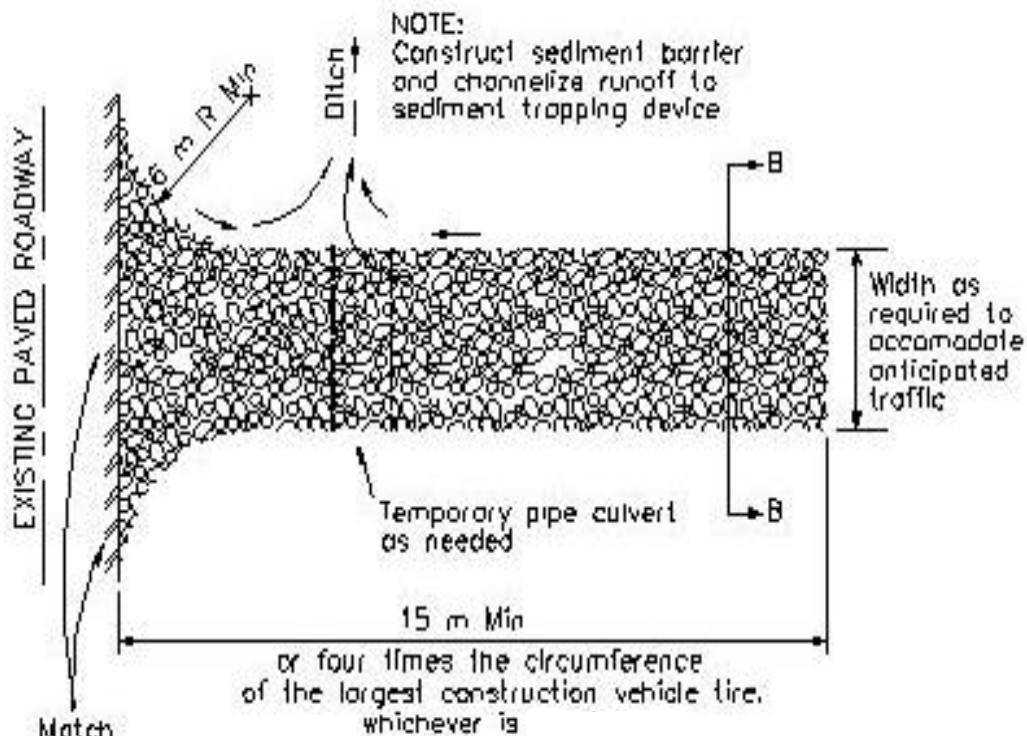

PLAN
NTS

Construction Site Entrances & Exits

SC-8

Graphic used with permission of Caltrans.

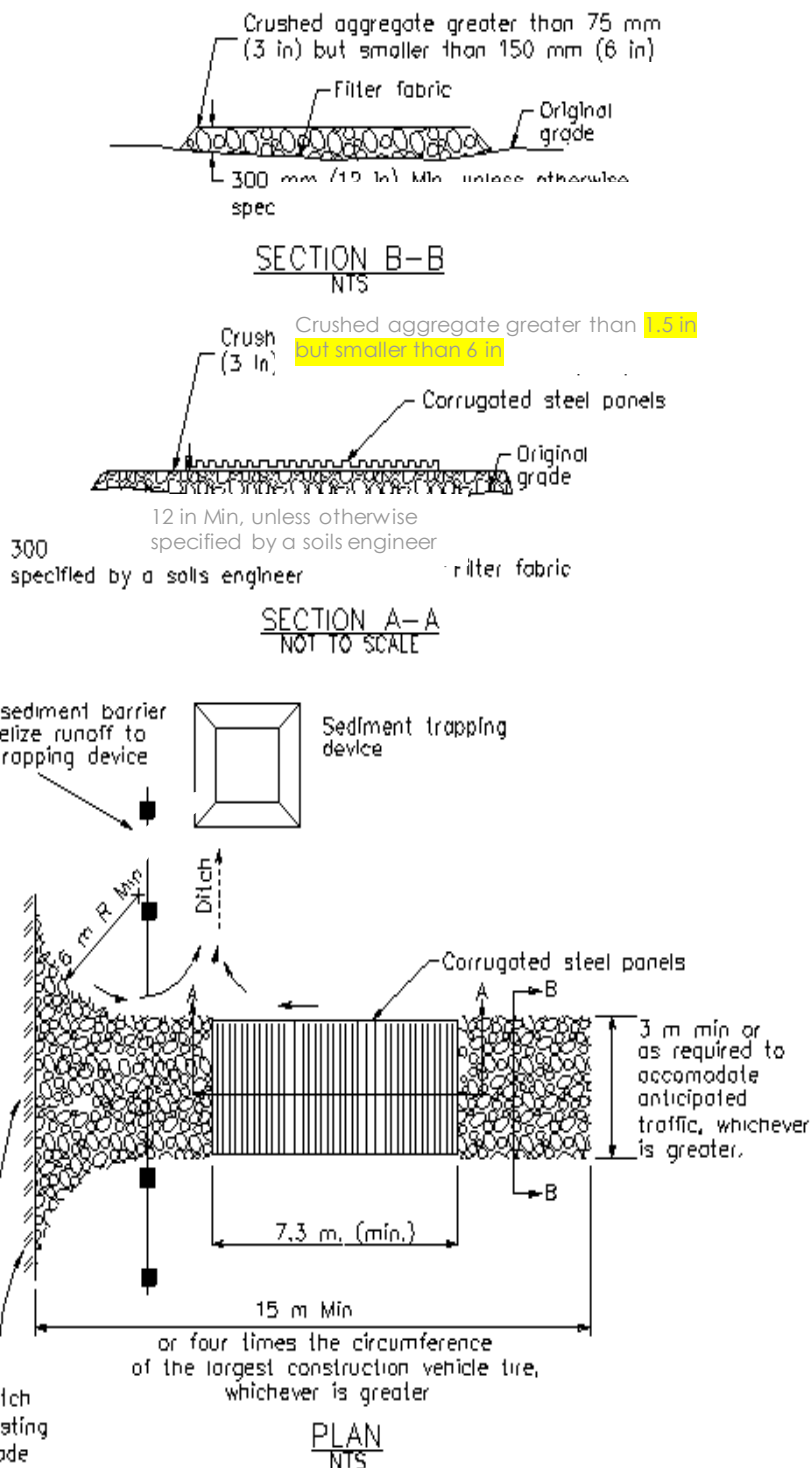

Graphic used with permission of Caltrans.

12 in Min, unless otherwise
specified by a soils engineer

10 ft min or as
required to
accommodate
anticipated
traffic, whichever
is greater.

Construction Exit Tire Wash

SC-9

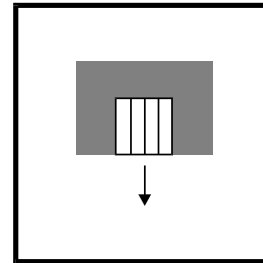
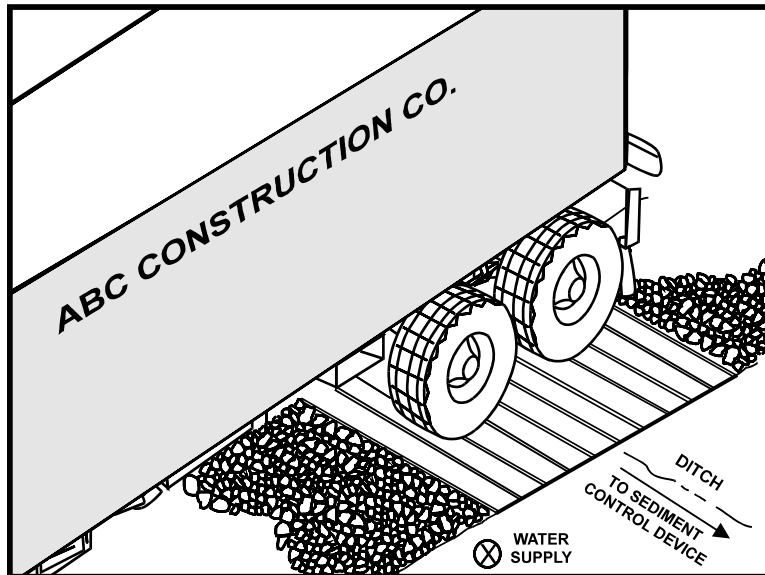

Map Symbol

Graphics used with permission of Caltrans

Purpose: To minimize the tracking of mud and dirt onto hard surfaced public roads by construction vehicle tires.

Applications:

- On construction sites where tracking onto public roads is a problem.

Limitations:

- Requires a source of wash water for the tire bath or pressure washing.
- Requires a double width entrance/exit to allow entering vehicles to avoid passing through the tire wash area.

Standards and Specifications:

- Use with a stabilized entrance/exit and sediment trap.
- Construct the tire wash on a level pad of coarse (3-6 inch) aggregate.
- Design, construct and manufacture the system for anticipated traffic loads.
- Minimize the depth of water in the sump to prevent damage to truck hubs and trailer tongues (12-14 inches).
- The slope of the sump shall be between 6-12 inches over a 10 foot width to allow sediments to flow to the low side and to prevent re-suspension of the sediments.

- Provide a drainage ditch to carry runoff from the wash area to a sediment sump device.
- When pressure washing is applied on-site, a grate over a sump may be used.

Inspection and Maintenance:

- Perform regular inspections to ensure that sediments are not tracked off site and that the wash area is functioning properly.
- Repair the tire wash as needed.
- Remove sediment accumulations from the wash rack or sediment sump.
- Collect waste or wash water generated onsite and treat or dispose of properly (do not discharge into the storm drain system).

Construction Exit Tire Wash

SC-9

Graphic used with permission of Caltrans.

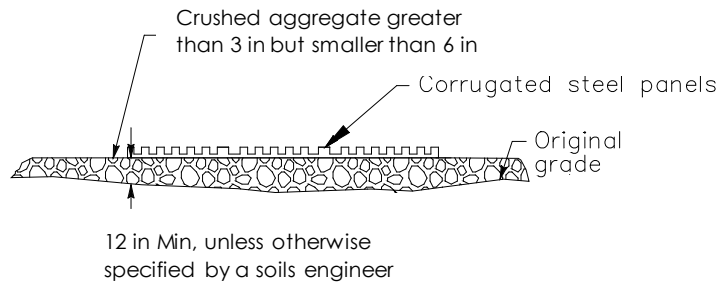

SECTION A-A
NOT TO SCALE

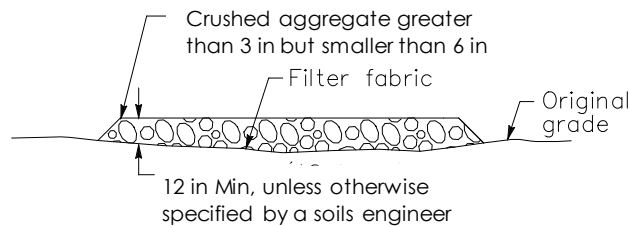

SECTION B-B
NTS

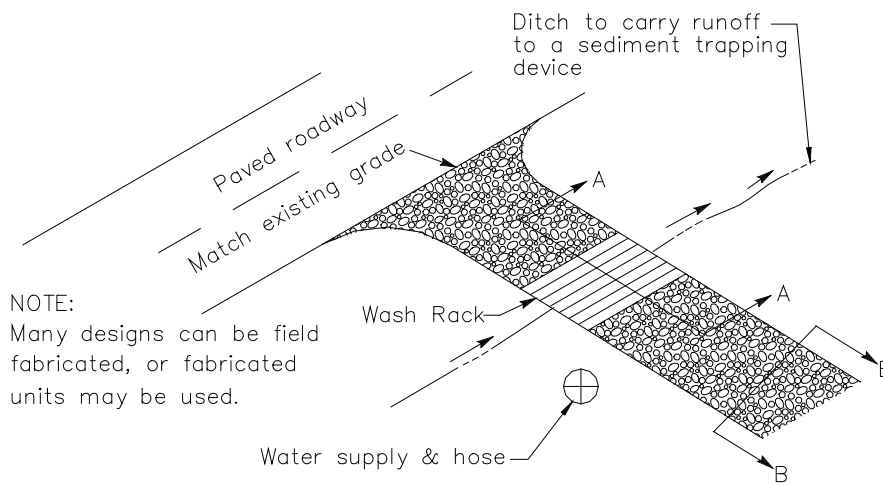

TYPICAL TIRE WASH
NOT TO SCALE

Stabilized Construction Roadway SC-10

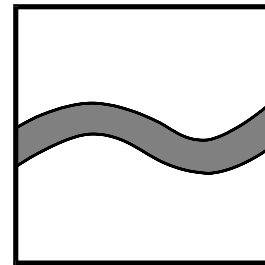
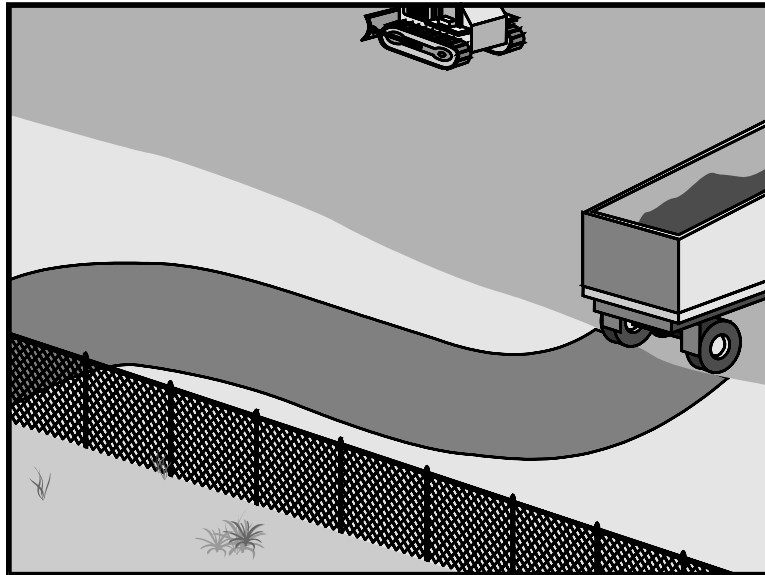

Map Symbol

Graphics used with permission of Caltrans

Purpose: To minimize erosion and to reduce the amount of sediment transported off site from construction sites.

Applications:

- Construction sites or short-term detour roads.
- Adjacent to water bodies.
- Where dust or mud tracking is a potential problem due to vehicular traffic.
- Parking areas for construction vehicles.

Limitations:

- Site conditions and layout will determine the design.
- May not apply to short term or small sites.
- Conform to applicable dust control BMP.
- Remove materials prior to final grading and site stabilization.

Standards and Specifications:

- Grade roads so that water will drain to the sediment traps and follow the contour of the natural terrain.
- Maximum roadway grade is 12 percent.
- Design for heaviest anticipated traffic loads.

Stabilized Construction Roadway **SC-10**

- Stabilize roadways with either concrete, asphaltic concrete or aggregate depending upon purpose and site conditions.

Inspection and Maintenance:

- Perform weekly inspections and complete repairs as needed.
- Require all vehicle traffic to use stabilized roads.
- Keep all temporary roadway ditches clear of sediments, debris and wastes.
- Remove at end of construction and regrade and repair slopes.

Synthetic Sediment Control Rolls SC-11

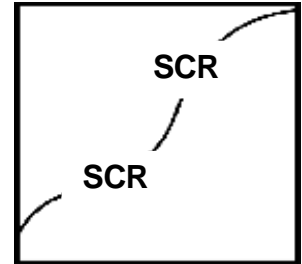
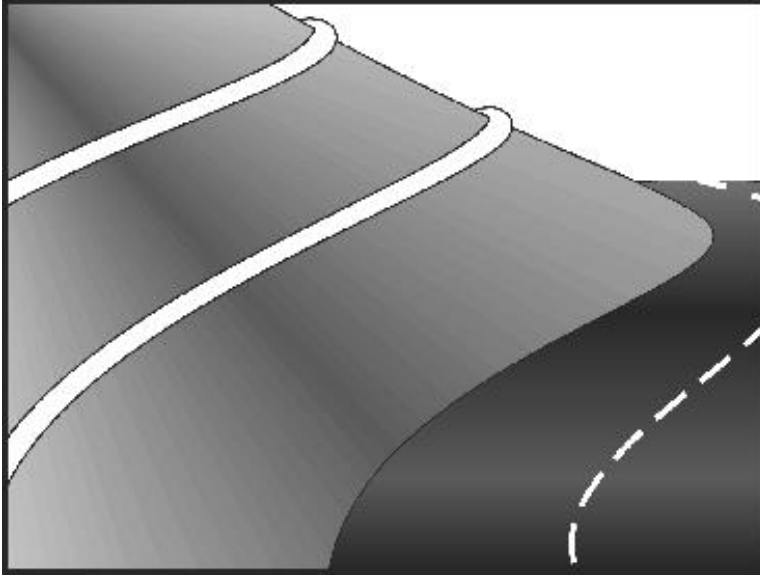

Map Symbol

Graphics used with permission of Caltrans

Purpose: Synthetic Sediment Control Rolls (SCRs) trap detached sediments and allow runoff to filter through the device. SCRs are reusable and constructed of overlapping layers of perforated polymeric sheets in hollow tubular assemblies. SCRs include location flaps and connecting sleeves and one or more filter sheets can be inserted into the SCRs to provide additional sediment filtration. **These rolls MUST be removed after construction site activities are completed and prior to the NOT.**

Applications:

- As check dams in drainage swales.
- If properly anchored, to protect storm drain inlets.
- Around temporary stockpiles.
- Along the perimeter of a project.

Limitations:

- Do not use SCRs on slopes as a permanent installation. Soil disturbance typically occurs during removal of SCRs.

Standards and Specifications:

- Configure SCRs from at least 95% Recyclable HDPE (#2) by weight and should be UV stabilized.

Synthetic Sediment Control Rolls

SC-11

- Materials used in the manufacture of SCRs should be chemically resistant to acids and bases, hydrocarbons and other materials typically found at construction sites.
- Materials used in the manufacture of SCRs should not be edible to animals.
- SCRs should be reusable for at least 4 years.
- Cut SCRs to-length in the field with standard handsaws, for field configurations, as required.
- SCRs provide variable filtration as per the requirements of the site.
- If necessary to create a turn (i.e. 45 deg. or 90 deg.), SCRs may be butted together tightly (by removing the sleeve insert) in such a way that no opening exists for sediment to pass through.
- SCRs do not require trenching. If properly stapled, the “location flap” should reduce potential undermining and undercutting.
- Drive Steel Staples (Wire Staple 8 gauge 1” X 1” X 6” minimum – longer for loose or sandy soils) through the “location flap” into the soil at a minimum of 3 staples per 5 foot length. More staples can be used where necessary (loose soil, or high flow areas). Orient staples parallel to the SCR in order to insert around both strands (top and bottom strands of the flap netting).

Inspection and Maintenance:

- Repair or replace split or torn SCRs.
- Inspect SCRs when rain is forecast and after storm events. Perform maintenance as needed.
- Maintain SCRs to provide an adequate sediment holding capacity. Sediment shall be removed when the sediment accumulation reaches two thirds (2/3) of the barrier height. Removed sediment shall be incorporated back onto the project or disposed of outside the project in conformance with local requirements.
- When no longer required for the intended purpose, temporary SCRs shall be removed from the site and stored for reuse or relocated to another location on the project. If not reusable due to damage, SCRs can be recycled as #2 (HDPE).
- If SCs are removed, collect and dispose of sediment accumulation.

Synthetic Sediment Control Rolls

SC-11

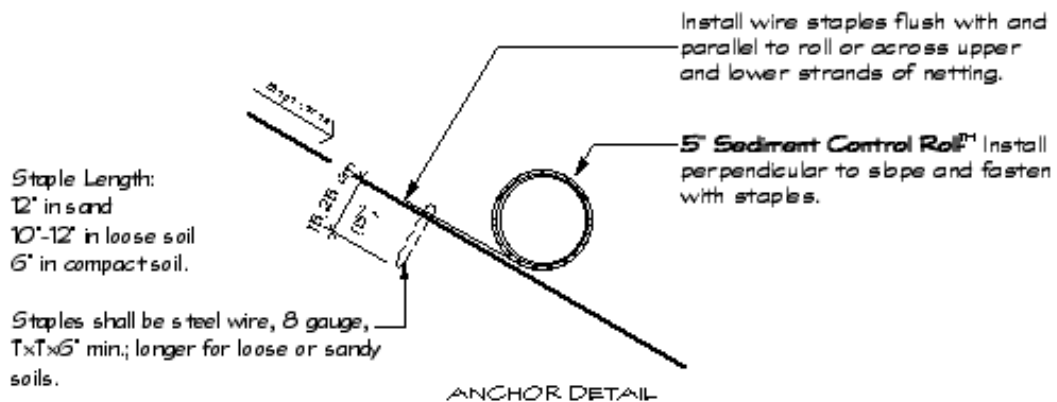
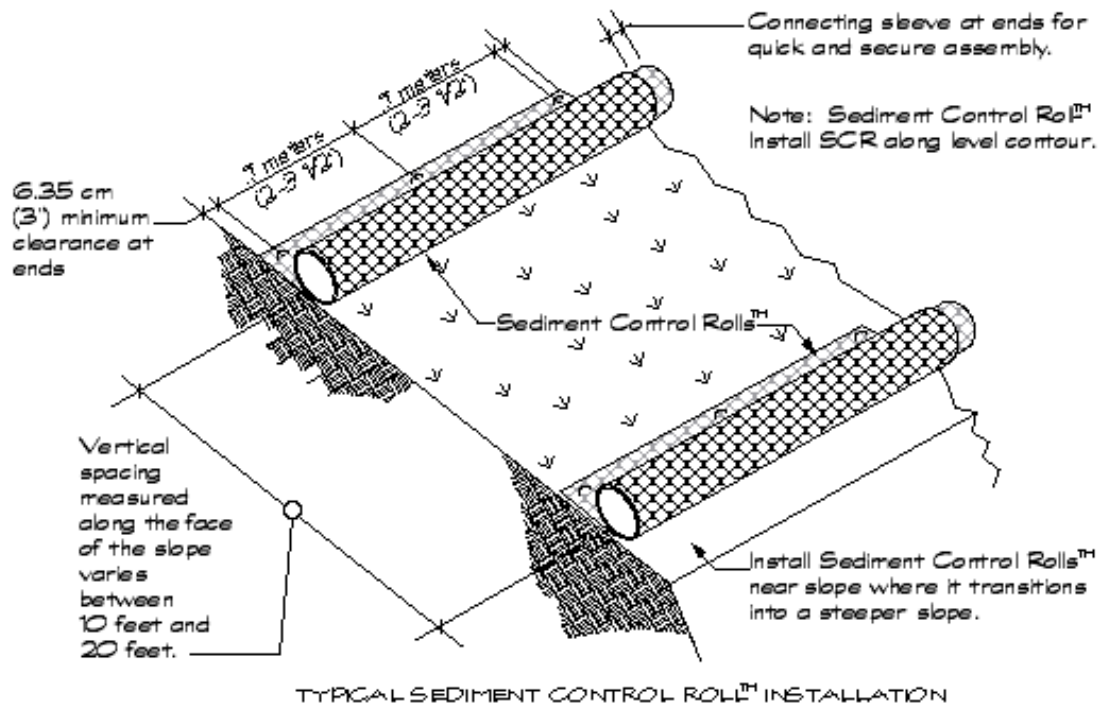

Graphic used with permission of Ertec Environmental Systems, LLC.

Synthetic Sediment Control Rolls

SC-11

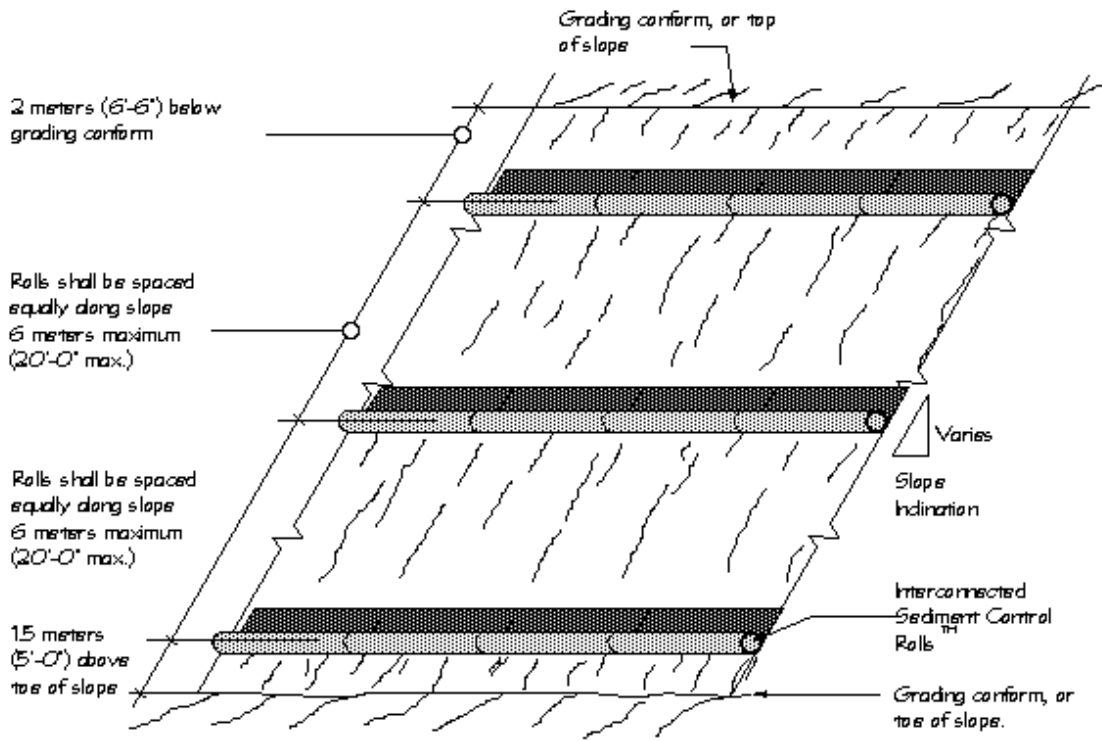

Perspective
Sediment Roll-Type 1

NOTE: Sediment Control Roll spacing varies depending up on slope inclination.

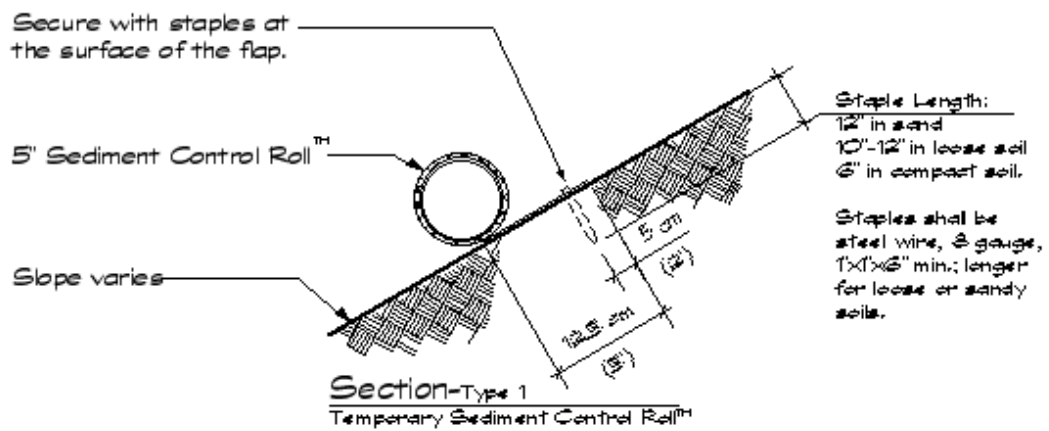

Section-Type 1
Temporary Sediment Control Roll™

Graphic used with permission of Ertec Environmental Systems, LLC.

Synthetic Sediment Control Rolls

SC-11

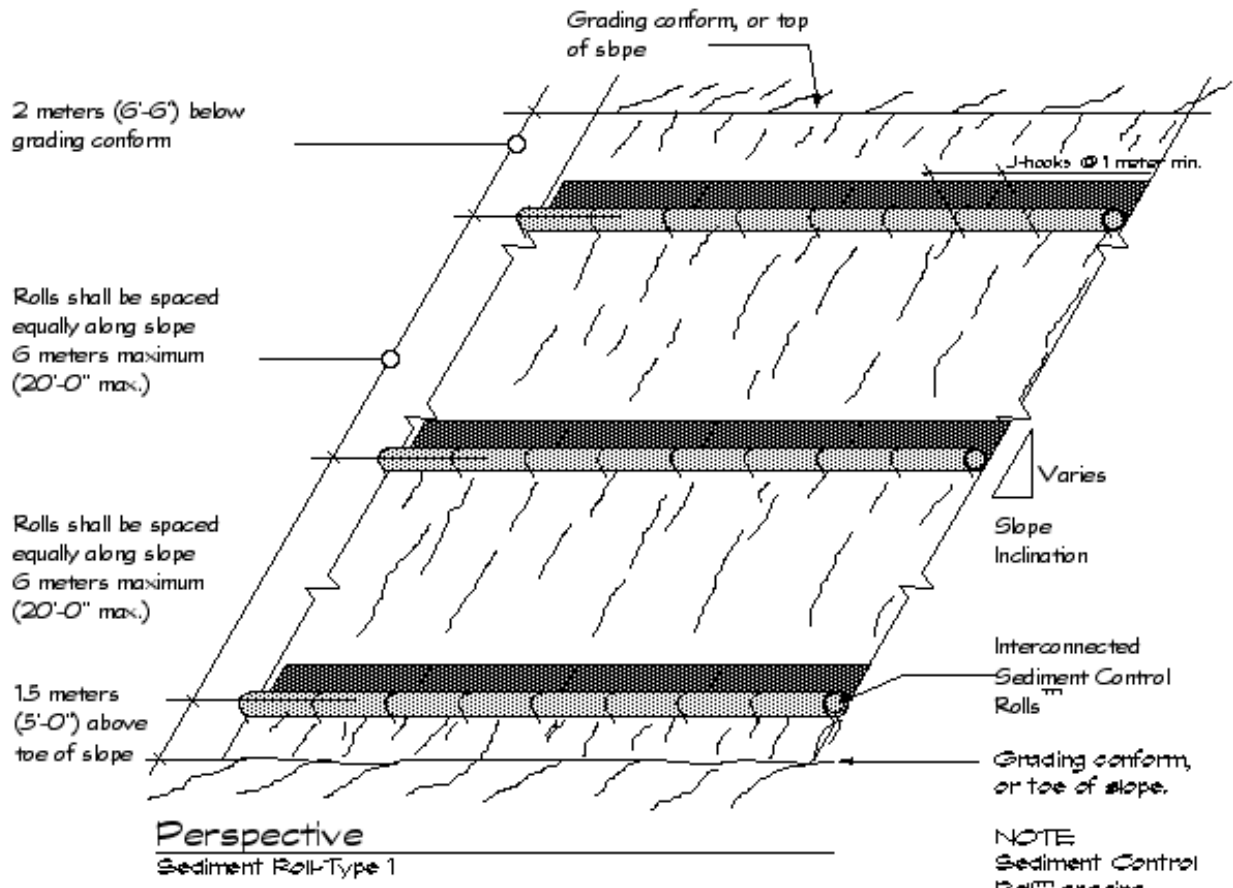

NOTE
Sediment Control Roll™ spacing varies depending upon slope inclination

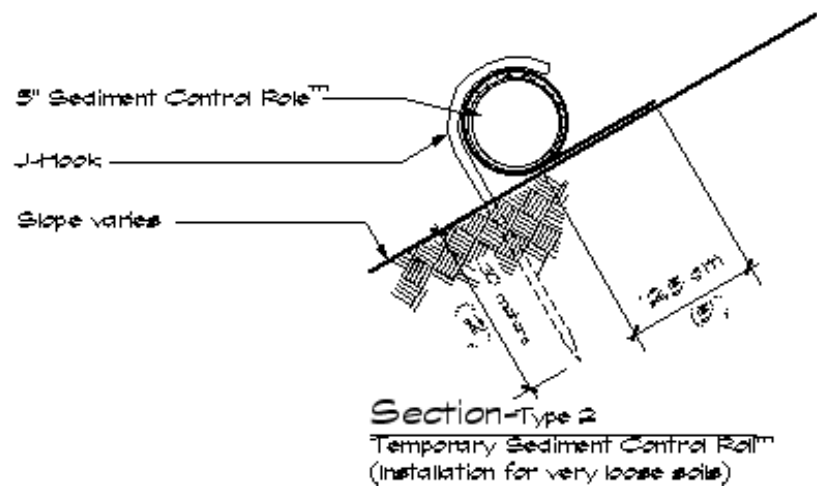

Synthetic Sediment Control Rolls

SC-11

Graphic used with permission of Ertec Environmental Systems, LLC.

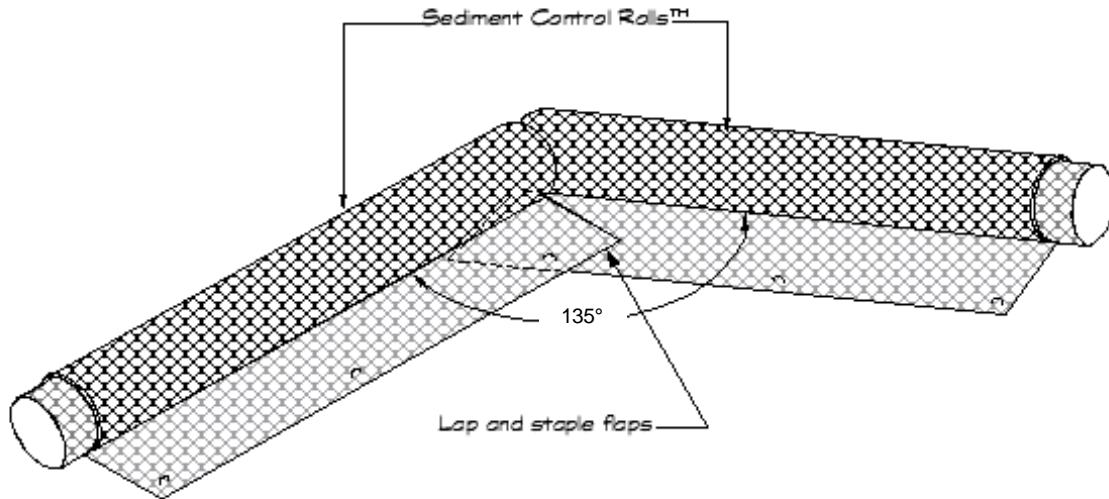

Angled
Installation— 135°

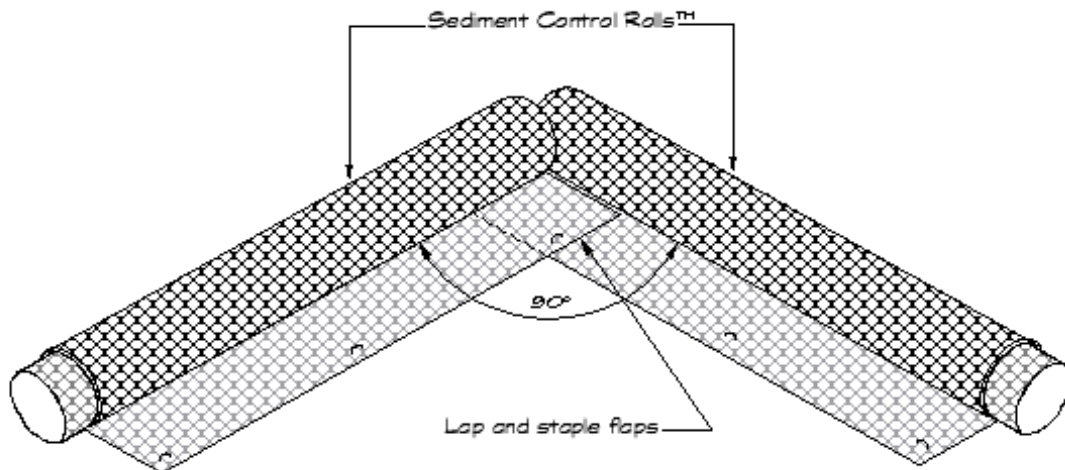

Angled
Installation— 90°

Graphic used with permission of Ertec Environmental Systems, LLC.

Section 10: Drainageway Protection Best Management Practices

This section presents the measures that can be temporarily used to protect streams and drainages located on or adjacent to construction sites that must be crossed by vehicles. Storm Drain Outlet Protection (D2) is necessary at all locations where discharge from an outlet may cause erosion. Storm Drain Inlet Protection (DP-3) and Catch Basin Filters (DP-4) are the control measures that can be temporarily used to protect storm drain inlets from receiving sediment-laden runoff during construction activities. With the exception of permanent storm drain outlet protection, these measures shall be removed when construction activities are complete and final site stabilization has been accomplished.

Table 10-1: Drainageway Protection Best Management Practices

BMP#	BMP Name	Temporary	Permanent
DP-1	Temporary Stream Crossing	T	
DP-2	Storm Drain Outlet Protection		P
DP-3	Storm Drain Inlet Protection	T	
DP-4	Catch Basin Inlet Filters	T	

Temporary Stream Crossing

DP-1

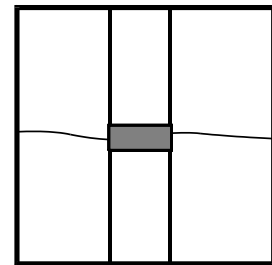
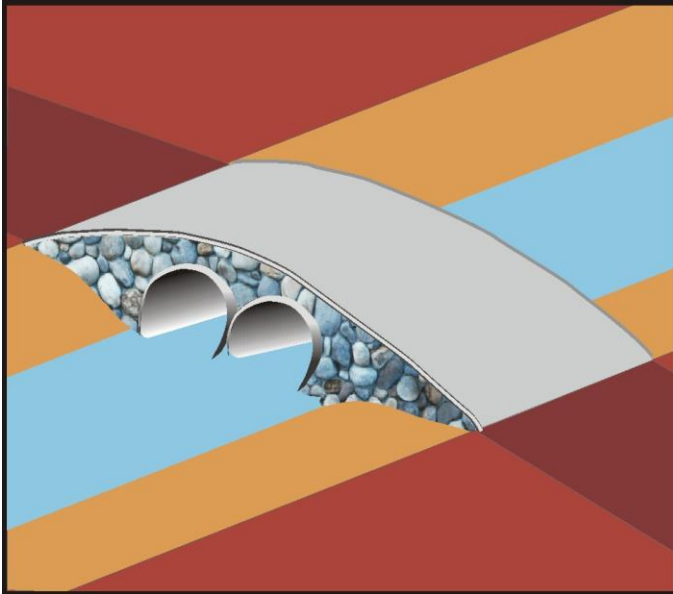

Map Symbol

Graphics produced by Kennedy/Jenks Consultants

Purpose: A temporary stream crossing is a culvert, bridge, or ford placed across a waterway for use by construction traffic. This structure stabilizes and minimizes erosion of the streambanks and channel.

Applications:

- At sites where construction vehicles will frequently cross a stream or waterway.
- At sites where duration of construction activities will not exceed one year.

Limitations:

- May require a U.S. Army Corps of Engineers 404 Permit, a 401 Water Quality Certification from NDEP, a State Lands authorization or other permits.
- Disturbance of the waterway will occur during the installation and removal of temporary stream crossings. Therefore, sediment control measures may need to be installed in the waterway during construction.
- Stabilize disturbed areas both during construction and after removal of the structure.
- Structures may obstruct flow in the waterway during prolonged storm events causing flooding and/or washouts.
- Diversion or dewatering of the channel may be required during the installation of the stream crossing structure.

Temporary Stream Crossing

DP-1

Standards and Specifications:

General Considerations

- A Nevada registered civil or structural engineer shall design and stamp plans for temporary stream crossing structures.
- Install sediment traps immediately downstream of crossings to capture sediments.

Temporary Bridge

- Must not restrict waterway area.
- Must span waterway with no intermediate supports
- Must be designed by a registered engineer and constructed to carry design traffic loads.

Temporary Culverts

- Typically used on perennial and intermittent streams.
- Install on a stabilized bed.
- Stabilize inlets and outlets.
- Stream channel banks and bed must be restored following culvert removal.
- Appropriate for streams with high flow velocities, steep gradients, or where temporary constrictions in the channel are not allowed.
- Must be engineered and constructed to carry design traffic loads.
- Must be designed with a capacity in accordance with City of Sparks *Hydrologic Criteria and Drainage Design Manual* – latest edition.
- Used in arid areas during the dry season for dry washes and ephemeral streams.
- Do not use on perennial streams.
- Design approach roads with a maximum slope of 7H:1V.
- Stabilize banks and roadbed to above design high water level.
- Use compacted aggregate to stabilize road surface.
- Do not apply oil or hazardous materials to the roadway.

Temporary Stream Crossing

DP-1

Inspection and Maintenance:

- Inspect weekly as well as before and after significant rainfall events.
- Inspect for sediment buildup in the culverts or blockage of the channel.
- Inspect for structural weakening of the temporary crossing.
- Inspect for channel sour, erosion of the abutments, riprap displacement, or piping in the soil.
- Remove silt behind fords, in culverts, and under bridges, and dispose of properly outside of the drainage path.
- Replace aggregate that has been lost from culvert inlets and outlets.
- Repair streambank erosion.
- Promptly remove temporary stream crossings when no longer needed.

Temporary Stream Crossing

DP-1

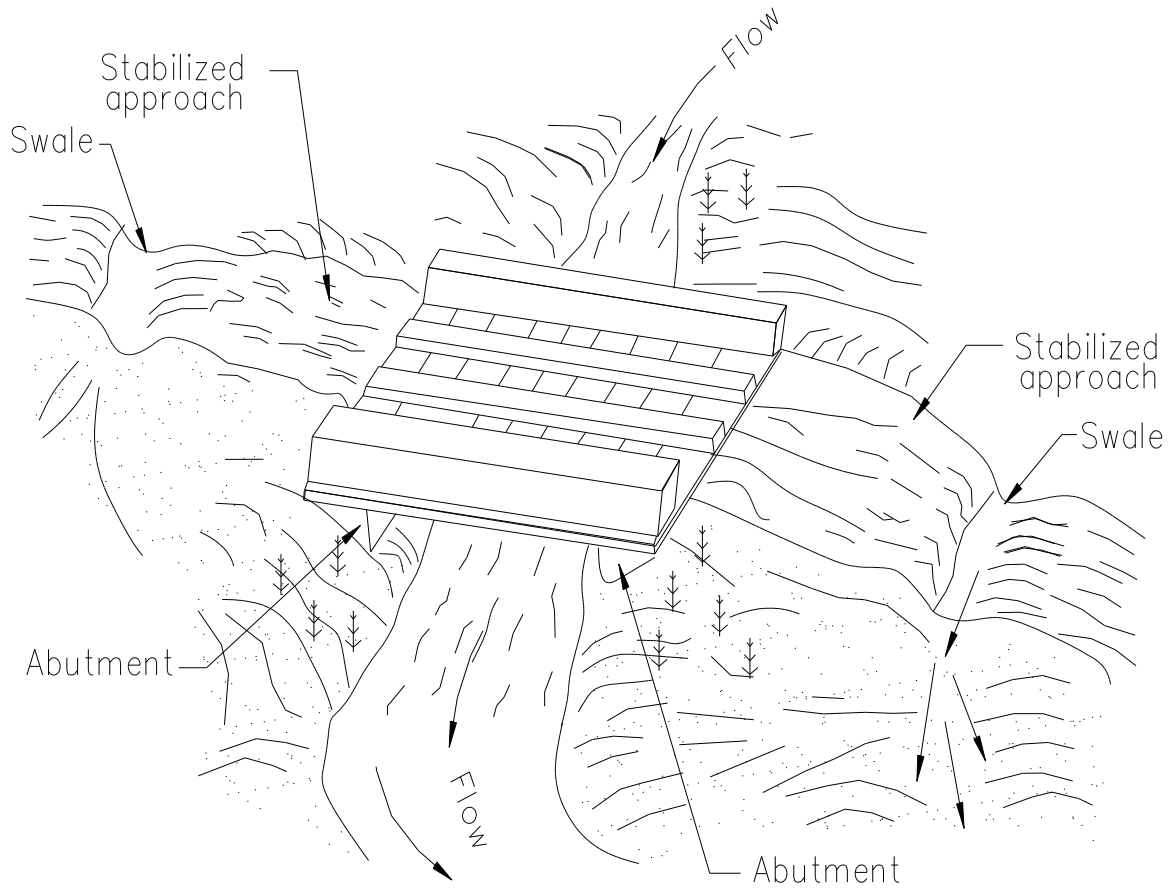

NOTE:

Surface flow of road diverted by swale and/or dike.

TYPICAL BRIDGE CROSSING

NOT TO SCALE

Graphic used with permission of Caltrans.

Temporary Stream Crossing

DP-1

½ Diameter of pipe 12 in, or as needed to support loads, whichever is greater.

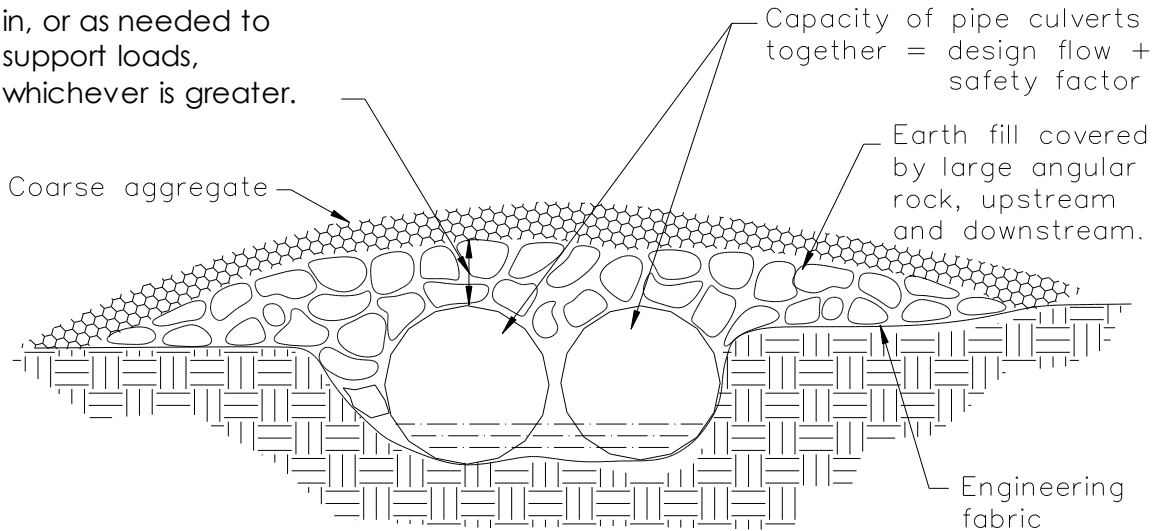

ELEVATION

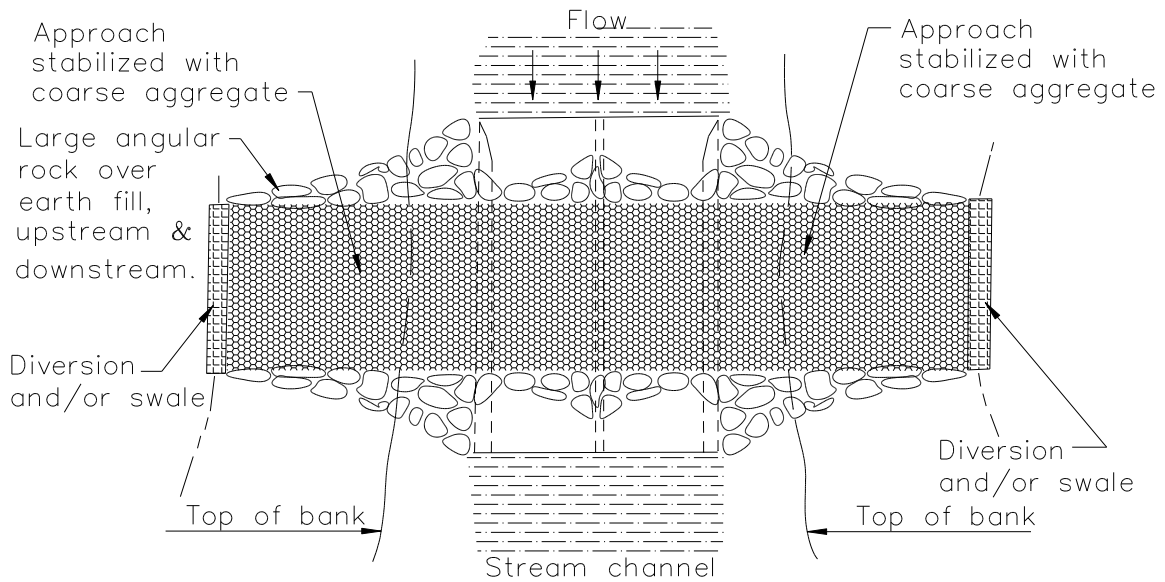

PLAN VIEW

TYPICAL CULVERT CROSSING
NOT TO SCALE

Graphic used with permission of Caltrans.

Temporary Stream Crossing

DP-1

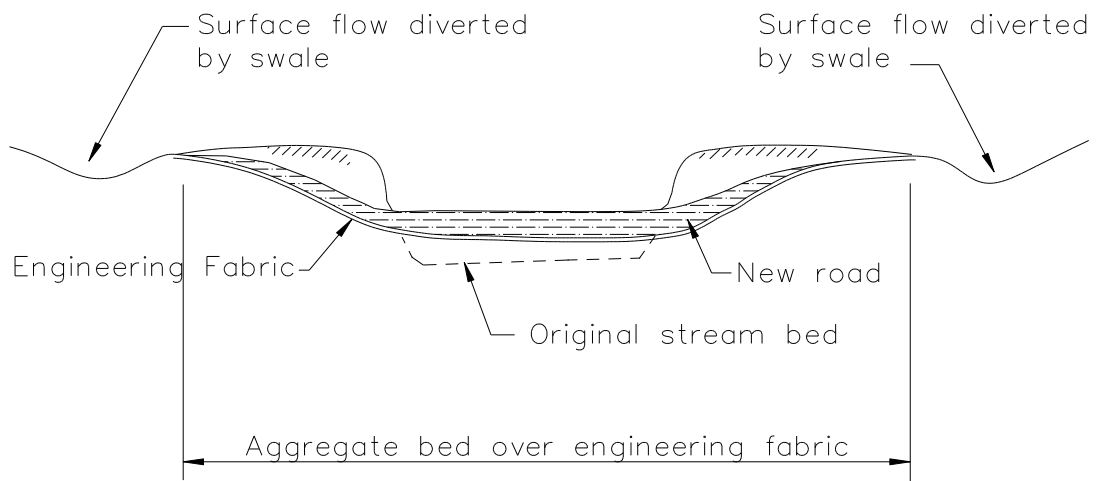
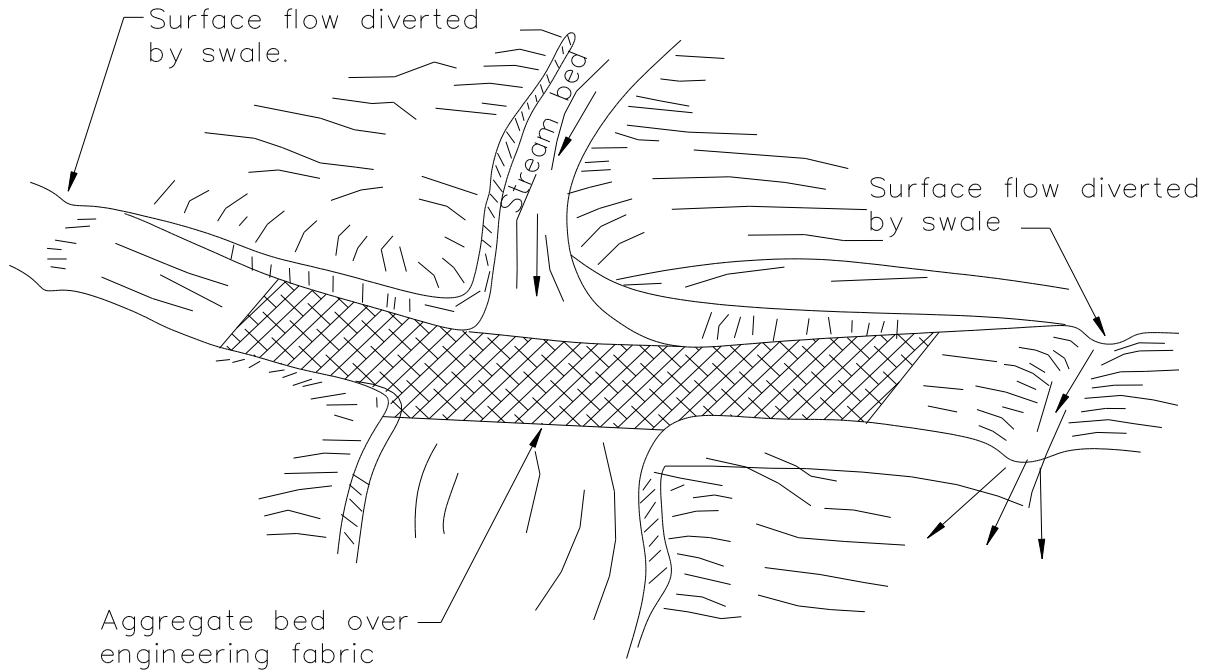

TYPICAL FORD CROSSING
NOT TO SCALE

Graphic used with permission of Caltrans.

Storm Drain Outlet Protection

DP-2

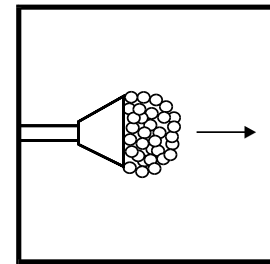
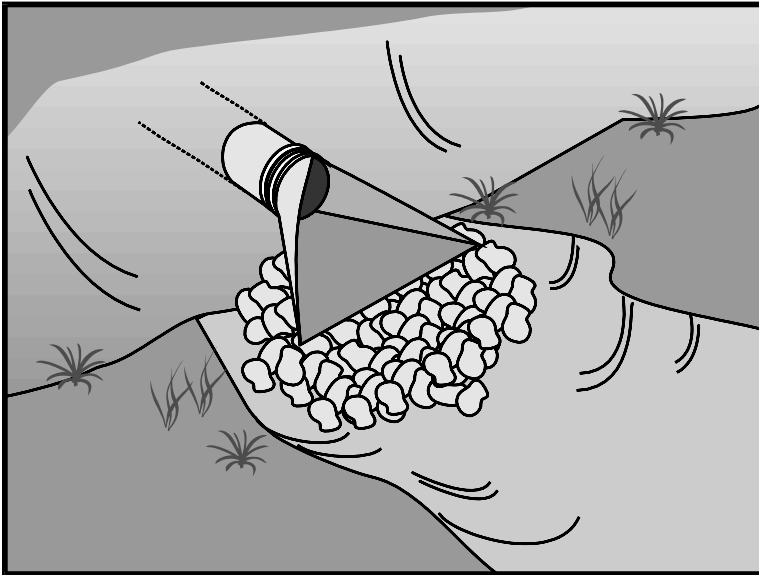

Map Symbol

Graphics used with permission of Caltrans

Purpose: To reduce storm water flow velocities and energy from construction sites by placing a section of rock at pipe outlets and within channels. Permanent installations must be designed per local standards noted in the City of Sparks Hydrologic Criteria and Drainage Design Manual – latest edition.

Applications:

- At locations where discharge velocities and energies may erode downstream reaches.
- Pipe, drain, culvert, conduit or channel outlets.
- At outlets located at the bottom of mild to steep slopes.
- At the outlets of channels that carry continuous flows.
- Outlets subject to short, intense flows of water.
- Points where lined conveyances discharge to unlined conveyances.

Limitations:

- Loose rock may be washed away during high flow events.
- Freeze and thaw cycles may break down grouted riprap.
- Inadequate design and installation may cause grouted riprap to break up due to hydrostatic pressure.

Storm Drain Outlet Protection

DP-2

Standards and Specifications:

- Design per local drainage design manual standards (use City of Sparks Hydrologic Criteria and Drainage Design Manual – latest edition for general design guidance).
- Install riprap, grouted riprap, or concrete aprons at all outlets. Riprap aprons are well suited for use during construction.
- Provide additional protection for outlets on slopes steeper than 10 percent.
- Higher outlet velocities require larger rocks.
- Flow must be slowed to non-erosive velocity.
- Align the apron with the receiving stream and keep it straight throughout its length. If a curve is needed to fit site conditions, place it in the upper section of apron.
- Protect with a gravel blanket if the riprap is too large.

Inspection and Maintenance:

- Inspect weekly and after every significant rainfall event.
- Check for displacement of riprap or damage to underlying fabric.
- Check for scour beneath the riprap and around the outlet.
- Replace riprap as needed.
- Repair damage to slopes or underlying filter fabric.
- Remove promptly all devices when the drainage area has been stabilized or at the completion of construction.
- Modify outlet protection if downstream erosion is evident.
- Remove temporary facilities from service when construction is complete. Outlet protection may be left in place if designed to be a permanent installation per local standards and specifications.

Storm Drain Outlet Protection

DP-2

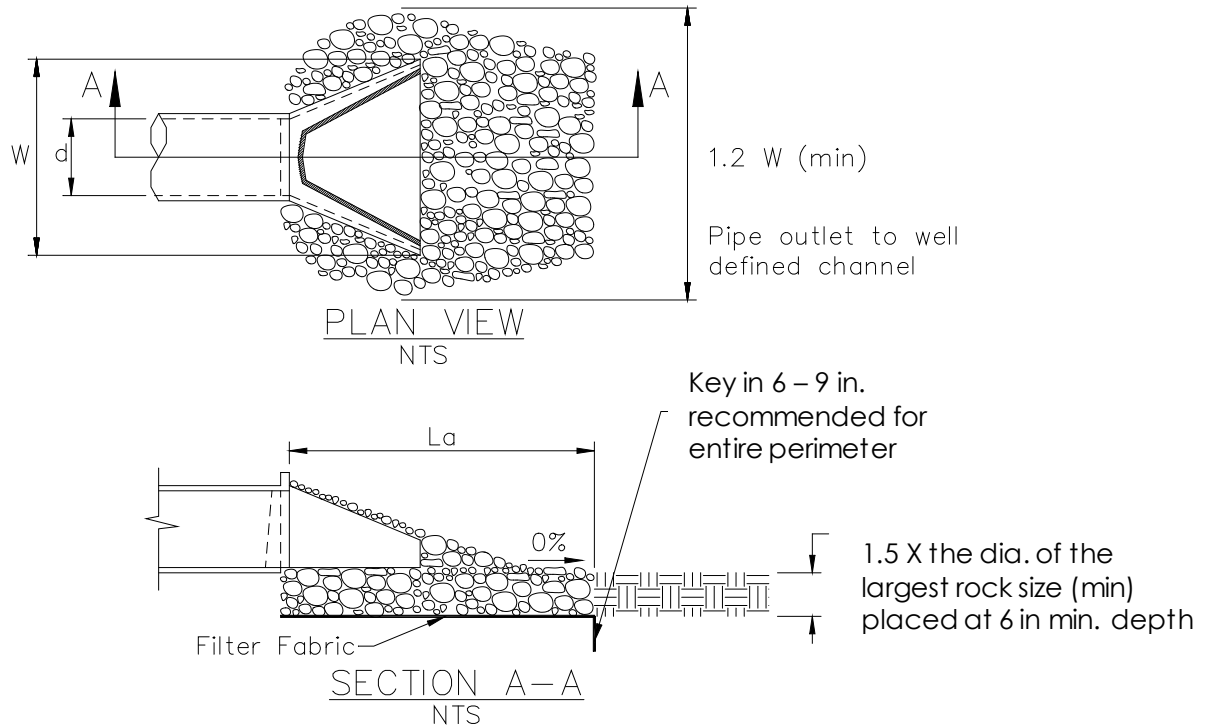

Graphic used with permission of Caltrans.

Pipe Diameter inches	Discharge ft ³ /sec	Apron Length, La feet	Rip Rap D₅₀ Diameter Min inches
12	4.9	10	4
	9.9	13	6
18	9.9	10	6
	20.1	16	8
	30.0	23	12
	39.9	26	16
24	30.0	16	8
	39.9	26	8
	50.1	26	12
	60.0	30	16
For larger diameters or higher flows, consult a NV Registered Civil Engineer			

Source: USDA – SCS

Storm Drain Inlet Protection

DP-3

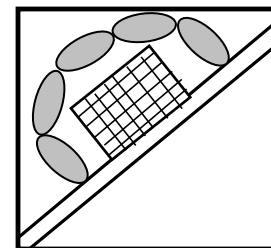
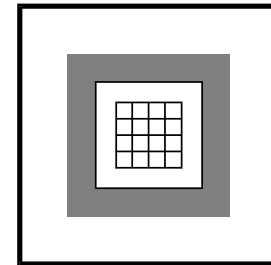
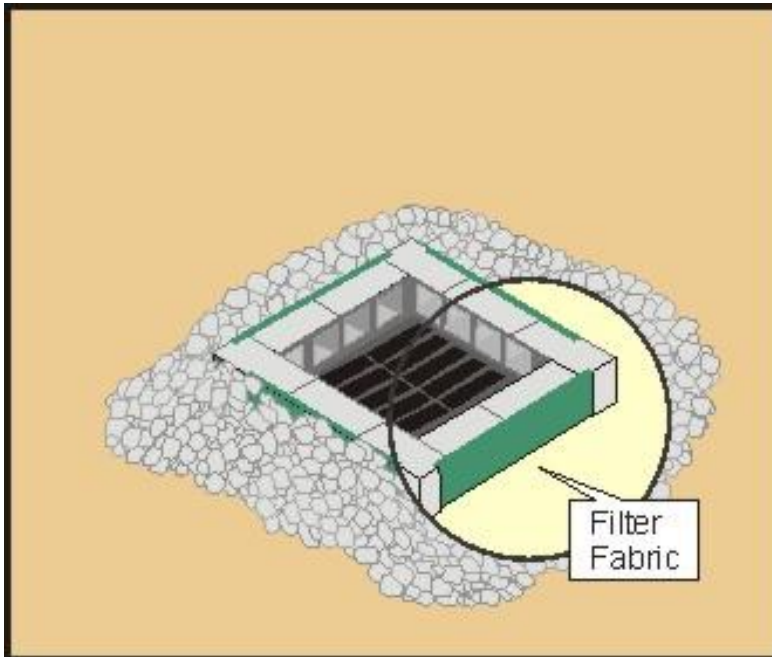

Map Symbols

Graphics produced by Kennedy/Jenks Consultants

Purpose: To allow ponding and filtering of sediment-laden runoff prior to entering the storm drain system.

Applications:

- Inlets potentially impacted by sediment laden surface runoff.
- Drainage areas 1 acre or less.
- Disturbed drainage areas that have not been permanently stabilized.
- Applicable for wet and snowmelt seasons.
- May not be necessary if storm drain discharges to a sediment retention basin.
- This BMP shall be the last line of defense for protection of the storm drain system.

Limitations:

- Not to be used when ponding will encroach into roadway traffic or onto erodible surfaces and slopes.
- Storm water will bypass protected curb inlets and continue downgrade on sloped surfaces.
- Sediment removal is not performed in high flow conditions.

Storm Drain Inlet Protection

DP-3

- Frequent maintenance is required to remove sediment and debris and replace BMP if clogged with sediment
- Route runoff to a sediment-trapping device if the drainage area is greater than 1 acre.
- Do not cover the inlet grate with filter fabric and do not place filter fabric beneath the grate.

Standards and Specifications:

Block and Gravel DI Protection

- Appropriate for drainage areas 1 acre and less with flows not exceeding 0.5 cfs.
- Allow for overtopping to prevent flooding.
- Place concrete blocks around inlet grate with openings parallel to the ground surface.
- Place filter fabric or wire screen around the outer openings and secure in place.
- Cover fabric or screen with 1 to 2 inch clean gravel approximately 1 foot wide.

Filter Fabric Fence (DI Protection Type 1)

- Appropriate for relatively small (less than 1 acre), flat (less than 5 percent slope) drainage areas subject to sheet flow and for flows not exceeding 0.5 cfs.
- Only surround inlet with filter fabric fence when it is located in a sump and the top of the fence is below the top of the surrounding slopes.
- Not appropriate for paved areas.
- Unless an approved catch basin filter device is used (see DP-4), filter fabrics shall not be placed over or underneath the inlet grate.
- Drive stakes a minimum of 8 inches into the ground. Stakes shall have a minimum dimension of 2 inches by 2 inches and be spaced a maximum of 3 feet apart.
- Bury the fabric filter at least 1 foot below the soil surface and rise no higher than 2 feet above the ground surface.
- Clean or replace the fabric when it becomes clogged with sediment.
- Remove sediment when the accumulation behind the fabric fence reaches one-third the height of the barrier.

Storm Drain Inlet Protection

DP-3

Sandbag Barrier (for Inlets on Grade)

- Sandbag barriers for inlet protection are applicable when sheet flows or concentrated flows exceed 0.5 cfs and when it becomes necessary to allow for overtopping to prevent flooding.
- Inspect bags for holes or rips.
- Remove the sediment behind the barrier when it reaches one-third the height of the barrier.

Excavated Drop Inlet Sediment Trap (DI Protection Type 2)

- Used where relatively heavy flows are expected and overflow capacity is needed.
- Size trap to provide a minimum storage capacity of 67 yd³/acre of drainage area.
- Remove sediments when the basin volume has been reduced by one half, disposing of them properly – away from the drainage path.

Below is an example of an Excavated Drop Inlet Sediment Trap (DI Protection Type 2)

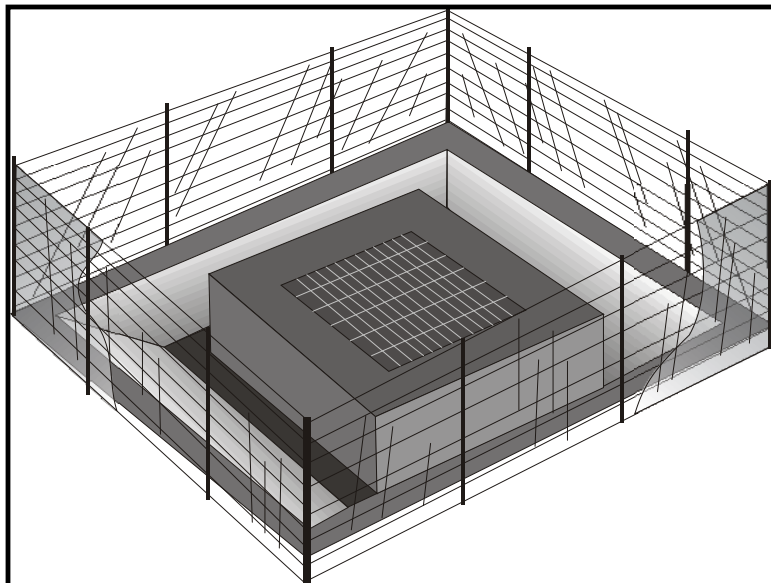

Graphic used with permission of Caltrans

Storm Drain Inlet Protection

DP-3

Inspection and Maintenance:

- Inspect before and after rainfall events and weekly during the wet/rainy season.
- Inspect inlet protection devices at least once every 24 hours during extensive rain events.
- Inspect storm drain inlets after severe storms in the rainy season for bypassed material.
- Properly dispose of accumulated sediments in appropriate manner out of the drainage path.
- From May to October, do not allow water to pond behind or within these control measures in excess of 7 days.
- Bring the disturbed area to the grade of the drop inlet and smooth and compact it. Appropriately stabilize all bare areas around the inlet.
- After site is stabilized, remove inlet protection devices or when protection is no longer needed.

Storm Drain Inlet Protection

DP-3

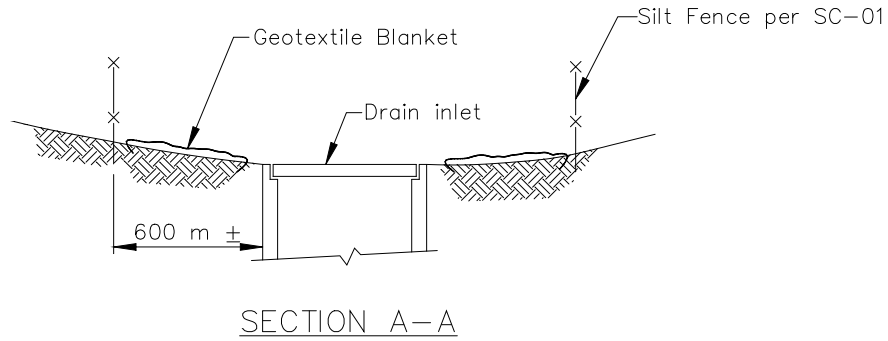

overlap at
silt fence.

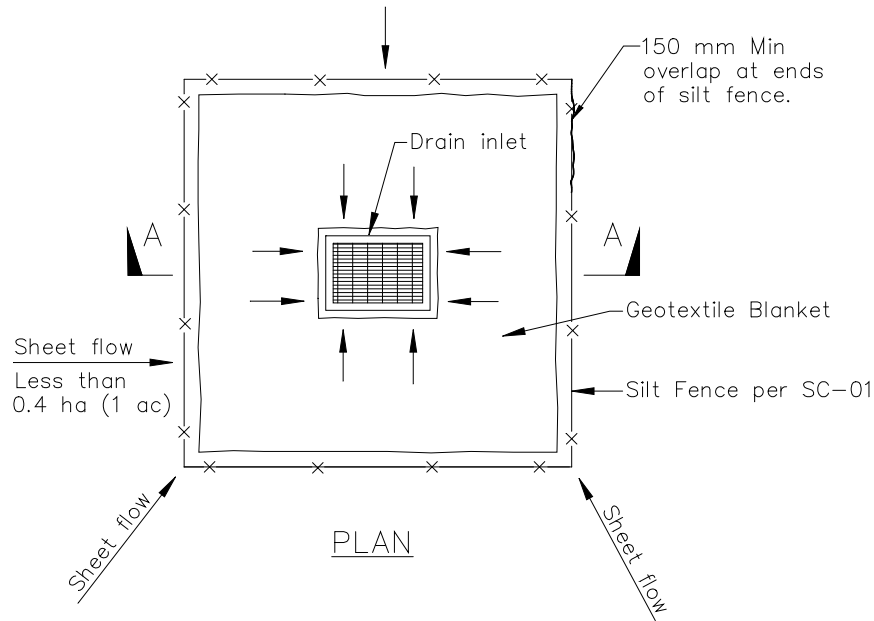

DI PROTECTION TYPE 1
NOT TO SCALE

NOTES:

1. For use in areas where grading has been completed and final soil stabilization and seeding are pending.
2. Not applicable in paved areas.
3. Not applicable with concentrated flows.

Graphic used with permission of Caltrans.

Storm Drain Inlet Protection

DP-3

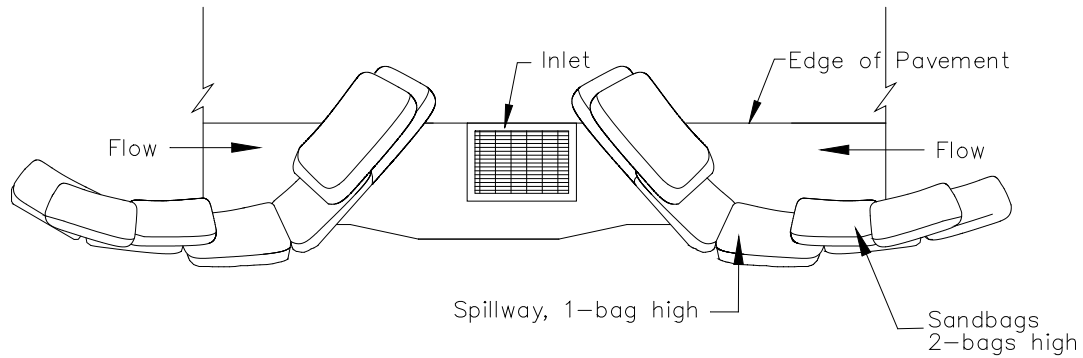

TYPICAL PROTECTION FOR INLET ON SUMP

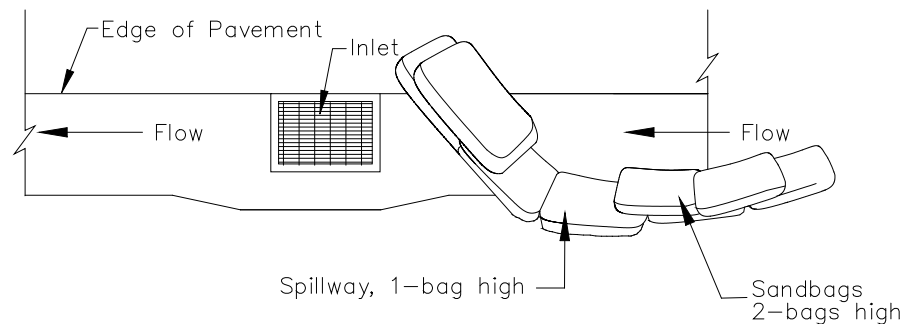

TYPICAL PROTECTION FOR INLET ON GRADE

NOTES:

1. Intended for short-term use.
2. Use to inhibit non-storm water flow.
3. Allow for proper maintenance and cleanup.
4. Bags must be removed after adjacent operation is completed
5. Not applicable in areas with high silts and clays without filter fabric.

Graphic used with permission of Caltrans.

Storm Drain Inlet Protection

DP-3

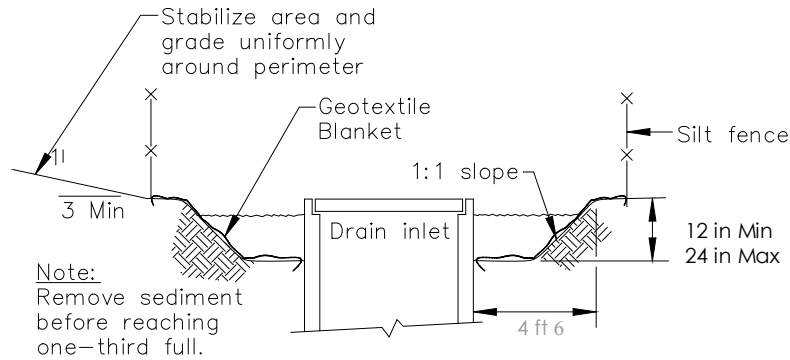

Section A-A

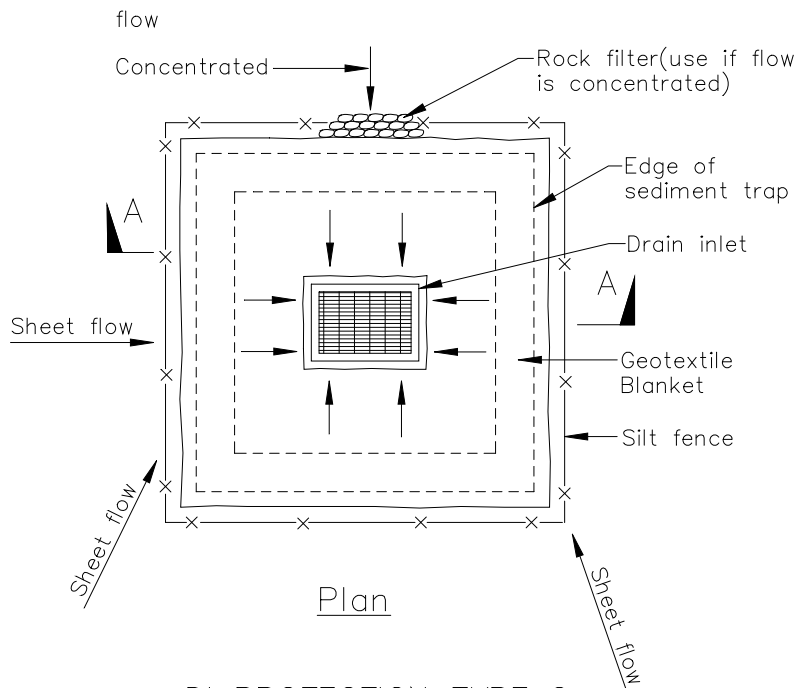

Plan

DI PROTECTION TYPE 2
NOT TO SCALE

Notes

1. For use in cleared and grubbed and in graded areas.
2. Shape basin so that longest inflow area faces longest length of trap.
3. For concentrated flows, shape basin in 2:1 ratio with length oriented towards direction of flow.

Graphic used with permission of Caltrans.

Catch Basin Filters

DP-4

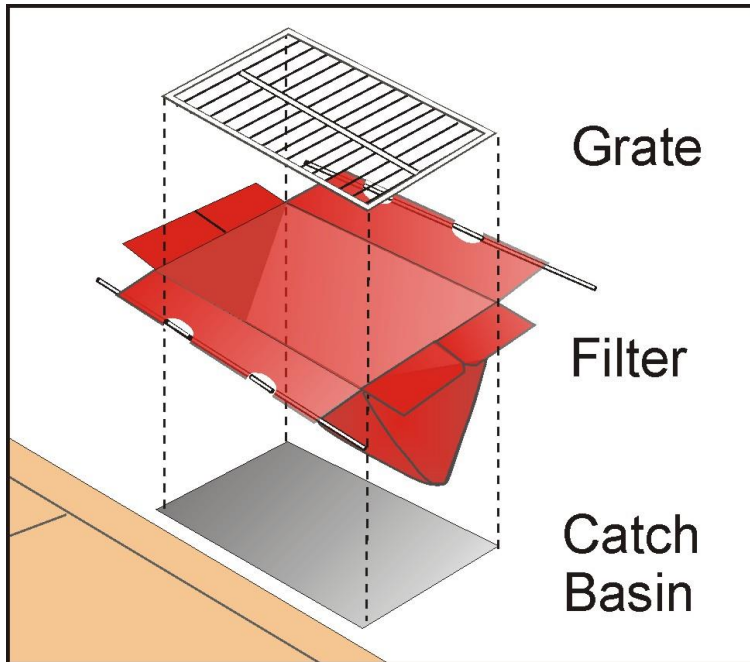

Graphic produced by Kennedy/Jenks Consultants

Purpose: To filter sediment-laden runoff and improve the quality of water entering the storm drain system. Filters are held in place by the catch basin grates.

Applications:

- At construction sites where disturbed areas may allow sediment laden water to enter catch basins or inlets.
- Where clogging of the drainage system by sediment laden storm water may be a problem.
- For use at sites where space or traffic constraints limit the use of other forms of storm drain inlet protection.

Limitations:

- To be used as a secondary sediment control with primary erosion control measures (hydroseeding, erosion control blankets).
- May cause flooding if not maintained.
- May cause a discharge of sediment to the storm drain system if filter fabric tears or pulls away from the grate.

Catch Basin Filters

DP-4

Standards and Specifications:

- Remove the drain gate and install the catch basin filter leaving 3 inches of flap exposed.
- Pinch the fabric between the grate and catch basin to ensure that the filter will be held in place.

Inspection and Maintenance:

- Inspect catch basin filters weekly and after every rain event.
- Empty catch basin filters when they are approximately half full.
- Follow manufactures guidelines for maintenance procedures, usually requires two people and two poles to remove.
- Properly dispose of sediments.
- Remove catch basin filters when construction activities are complete and final site stabilization has been accomplished.

Section 11: General Site and Materials Best Management Practices

This section presents control measures that can be used to manage construction site materials and wastes and manage maintenance, fueling and cleaning activities in order to reduce or eliminate discharges on and offsite and into receiving waters. Proper management of materials and wastes at construction sites can significantly reduce pollution in storm water.

Table 11-1: General Site and Materials Management Best Management Practices

BMP#	BMP Name	Temporary	Permanent
GM-1	Water Conservation Practices	T	P
GM-2	Stockpile Management	T	
GM-3	Solid and Demolition Waste Management	T	
GM-4	Dewatering Operations	T	
GM-5	Street and Surface Cleaning	T	
GM-6	Spill Prevention and Control	T	
GM-7	Vehicle and Equipment Cleaning	T	
GM-8	Vehicle and Equipment Maintenance and Fueling	T	
GM-9	Handling and Disposal of Concrete and Cement	T	
GM-10	Material Delivery, Handling, Storage and Use	T	
GM-11	Paints and Liquid Materials	T	
GM-12	Pavement Construction Management	T	
GM-13	Liquid Waste Management	T	
GM-14	Sanitary/Septic Waste Management	T	
GM-15	Landscaping and Revegetation Management	T	P
GM-16	Contaminated Soil and Water Management	T	
GM-17	Hazardous Waste Management	T	
GM-18	Illicit Discharges and Connections – Detection and Reporting	T	
GM-19	Drilling and Pile Driving Operations	T	
GM-20	Material and Equipment Use Over Water	T	
GM-21	Structure Demolition/Removal Over or Adjacent to Water	T	P
GM-22	Temporary Batch Plants	T	

Water Conservation Practices

GM-1

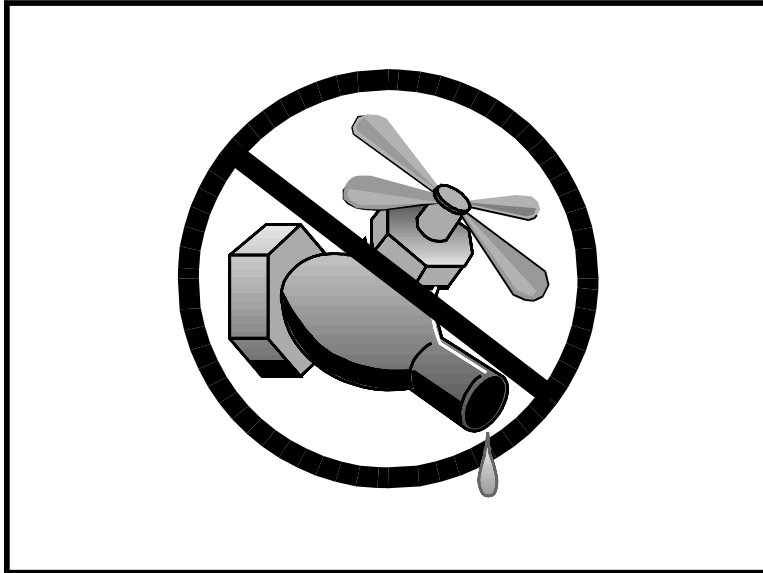

Graphics used with permission of Caltrans

Purpose: The potential for erosion and pollutants being transported offsite can be reduced by appropriately restricting the use of water on construction sites.

Applications:

- Implemented in all situations where water is used.
- Used on all construction sites.

Limitations:

- None have been identified.

Standards and Specifications:

- To determine an appropriate amount of water for a given area, take into consideration factors such as soil type and structure, grade, season, climate, and type of plant material.
- Where possible, direct construction runoff to areas where it can soak into the ground.
- Use minimal amounts of water to control dust and avoid washing sediments into the drainage system.
- Limit irrigation.
- Maintain water equipment in good working condition.
- Repair water leaks promptly.
- Discourage washing of equipment and vehicles on construction sites or conduct washing activities only in designated contained areas.

- Keep paved areas swept and vacuumed.
- When washing vehicles and equipment on-site:
 - Minimize water use and contain all runoff on-site.
 - Do not use detergents or chemicals.
 - Use a commercial wash facility whenever possible.

Inspection and Maintenance:

- Inspect water equipment a minimum of twice weekly.
- Shut off water and repair broken lines, sprinklers, or valves as soon as possible to prevent excess water use.

Stockpile Management

GM-2

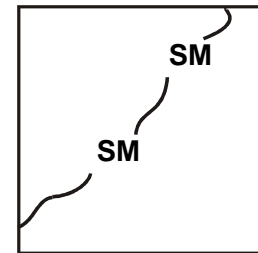
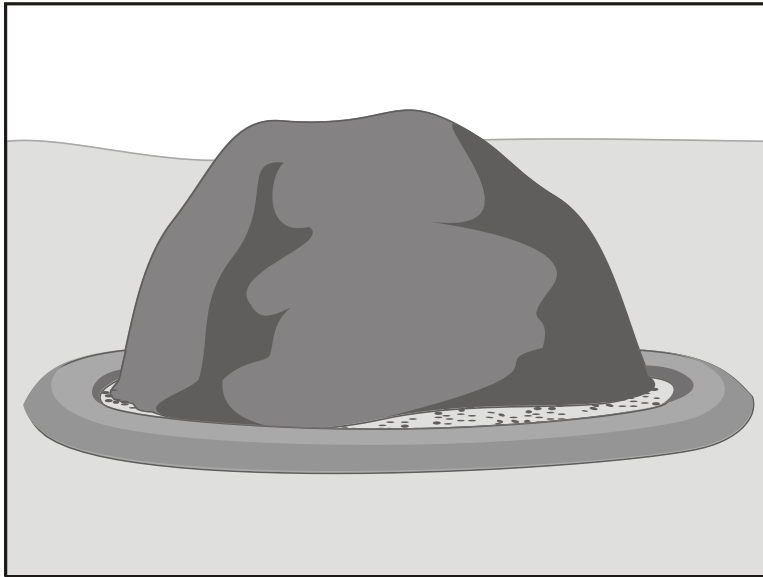

Map Symbol

Graphics used with permission of Caltrans

Purpose: Proper management of stockpiled materials can reduce or eliminate pollution of storm water from these sources.

Applications:

- All locations and projects where materials such as soils, composts, aggregates, and paving materials are stockpiled.

Limitations:

- None have been identified.

Standards and Specifications:

- Locate stockpiles away from storm water flows, drainage courses and inlets.
- Apply wind erosion and dust control measures on the surface of stockpiles (see EC-5).
- Revegetate if stored more than 60 days.
- Place bagged materials on pallets and cover (see GM-10 and GM-11).
- Maintain stockpile management controls year-round.
- Install stockpile perimeter controls such as temporary berms, dikes, silt fences, fiber rolls, sandbags or gravel bag barriers as soon as possible after stockpiles are created. These temporary sediment transport barriers can be temporarily removed or moved to one side when materials are removed or added to the stockpile.

Stockpile Management

GM-2

- If stockpiles are not to be used within 21 days, temporary cover (e.g. hydromulch with soil binders), must be installed as soon as practicable and no later than 14 days after stockpiles are created. Cover shall be placed on stockpiles as soon as practicable where the initiation of temporary covers is precluded by snow or frozen ground conditions.

Inspection and Maintenance:

- Inspect perimeter controls and covers weekly and before and after storm events.
- Inspect temporary cover before, during and after windy weather.
- Replace or repair perimeter controls and cover as needed.
- Inspect for weed infestations and treat as needed

Solid & Demolition Waste Management GM-3

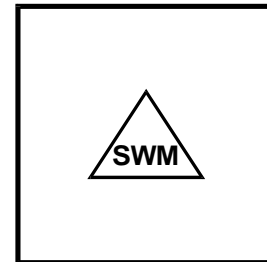
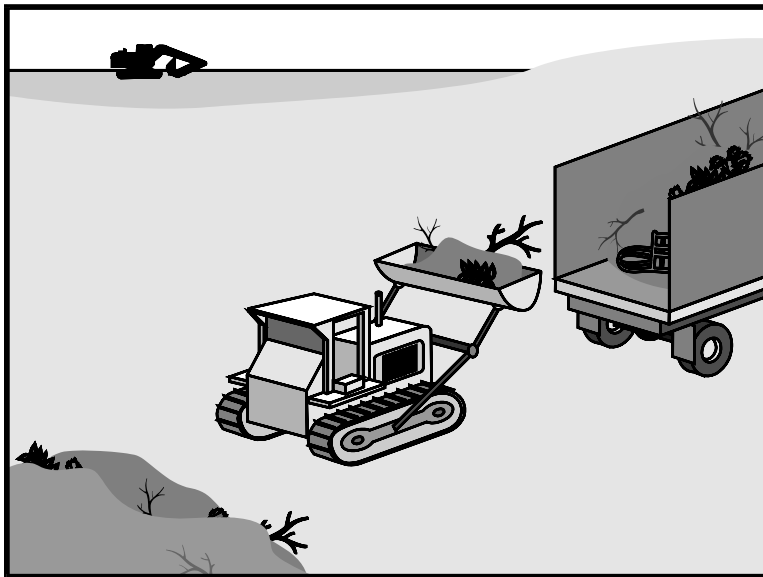

Map Symbol

Graphics used with permission of Caltrans

Purpose: Proper management through the routine collection and regular disposal of soil and demolition wastes will prevent or reduce the discharge of pollutants to the storm drain system.

Applications:

- All construction projects that generate non-hazardous solid wastes. These wastes include:
 - reusable materials (doors, banisters, windows, 2x4s),
 - recyclable materials (metal framing, concrete, brick, asphalt, cleared vegetation), and
 - non-recyclable materials (non-hazardous paint chips, steel and metal scraps, broken paving materials, domestic wastes).

Limitations:

- Temporary stockpiling of construction wastes may require stockpile management controls.

Standards and Specifications:

- Designate on-site waste collection areas away from streets, gutters, storm drains, and construction site entrance.
- Train employees and subcontractors in proper solid waste management.
- Reuse and recycle construction materials and wastes whenever possible.
- Collect construction site litter and debris daily.

Solid & Demolition Waste Management GM-3

- Do not dispose of toxic liquid wastes and chemicals in dumpsters designated for construction debris.
- Do not wash out dumpsters on-site.
- Replace leaky dumpsters.
- Clean up spills immediately.
- Cover dumpsters at night and during rainy or windy weather.

Inspection and Maintenance:

- The construction supervisor shall monitor on-site solid waste storage and disposal.
- Inspect dumpsters for leaks and secure covers.
- Arrange for regular waste collection.
- Immediately cleanup and remove any materials, debris or wastes that fall into waterways and drainage ways on or adjacent to the site.

Dewatering Operations

GM-4

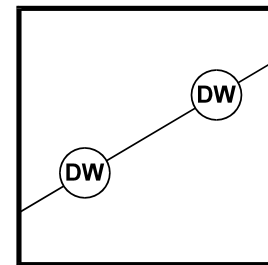
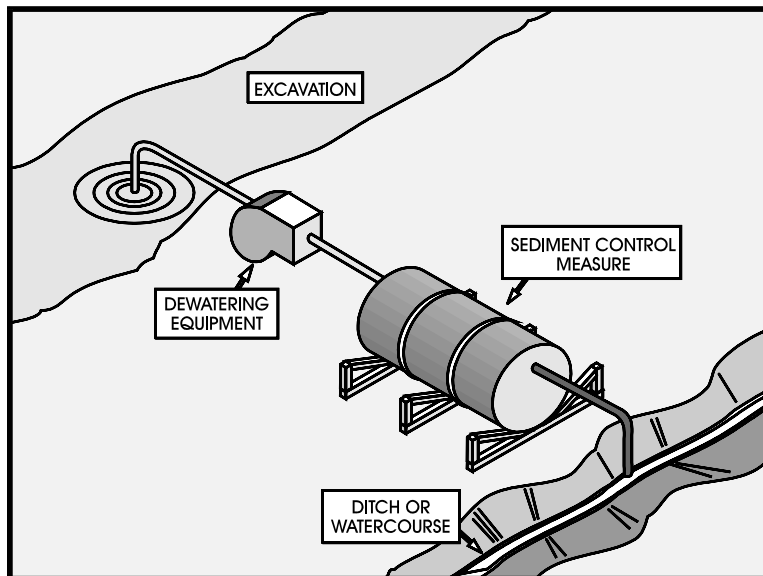

Map Symbol

Graphics used with permission of Caltrans

Purpose: Dewatering is often necessary to remove accumulated storm water or non-storm water from excavations or other depressions on a construction site. To prevent pollutants contained in the removed water from entering the storm drain system a variety of sediment controls may be used.

Applications:

- Applied on construction sites whenever water must be removed using a dewatering pump and the discharge is to a surface water or the storm drain system.
- May be used in conjunction with sediment traps or basins on construction sites that do not drain within 7 days from May to October.
- Applied to remove uncontaminated groundwater or waters accumulated in sumps or BMPs on the job site.

Limitations:

- Discharged water must be able to flow through the dewatering system without overflowing the structure.
- Dewatering practices should be used as a last resort control measure.
- Design and use will be determined by on-site conditions.
- When removing contaminated waters or hazardous substances, the contractor shall implement appropriate pollution controls.
- May need to obtain and comply with local permits.
- A temporary discharge permit is required from NDEP if the discharge rate exceeds 250 gpm or the dewatering period exceeds 48 hours.

The following suggested BMPs are primarily meant for sediment removal only. If waters present at the site are determined to be polluted or containing hazardous substances, additional controls must be implemented. And local environmental control authorities must be notified.

Standards and Specifications:

- Regional and watershed-specific discharge requirements must be followed.
- NDEP may require an additional NPDES Dewatering Permit for the discharge of accumulated non-storm water, including but not limited to groundwater, water from cofferdams, de-watering of piles, and water diversions.
- A dewatering plan shall be included in the SWPPP detailing the location of the dewatering, equipment used, and the discharge point.
- Records of dewatering activities shall be maintained for a minimum of three years.
- Do not allow discharges to cause erosion at the discharge point.

Inspection and Maintenance:

- Regular inspection is necessary to ensure that the structure is functioning efficiently.
- Do not discharge waters into the storm drain system or waters of the state when using floating suction hoses.

Implementation:

1. Sediment Traps - See Fact Sheet SC-6

- A sediment trap consists of a temporary basin formed by excavation or construction of an embankment across a drainage way. Water is detained in the structure and sediment is allowed to settle out. Water exits the trap via a reinforced spillway.
- Effective for removal of large and medium sized sediment.
- Requires excavation and cannot be transported to various discharge points.

2. Sediment Basins – See Fact Sheet SC-7

- A sediment basin is similar to a sediment trap except that the outlet structure consists of a perforated riser pipe, rather than a spillway.
- Effective for removal of trash and gravel through silt-sized sediment.

3. Weir Tanks

- A weir tank is a mobile unit which separates waste by passing water through a series of weirs, maximizing the residence time within the tank and removing oil, grease and sediments.
- Tanks can be used as a component in a treatment train if desired, or set up in parallel to allow for larger discharge volumes.

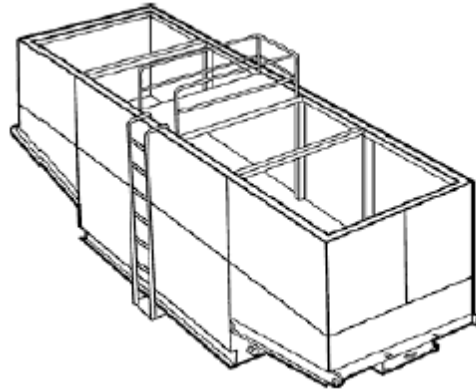

Graphics Source: CASQA

- Tanks of various sizes, for different flow volumes and contaminants of concerns are available from a variety of vendors. Vendors will deliver the tank to the construction site and assist with set-up and operation.
- Frequent cleaning may be required to maintain functionality. Oil and grease must be disposed of by a qualified entity.
- A Professional Engineer is required to determine the appropriate size of tank required.



4. Dewatering Containers

- A dewatering container is a mobile unit which removes debris and sediment employing a filter fabric. Flow enters the tank through the top, passes through the filter, and discharges through the bottom.
- Dewatering tanks typically remove trash, gravel, sand, and silt, with limited effectiveness for removing oil and grease and metals.
- Tanks can be used as a component in a treatment train if desired, or set up in parallel to allow for larger discharge volumes.
- Tanks of various sizes, for different flow volumes and contaminants of concerns are available from a variety of vendors. Vendors will deliver the tank to the construction site and assist with set-up and operation.

Dewatering Operations

GM-4

- Frequent cleaning may be required to maintain functionality. Oil and grease must be disposed of by a qualified entity.
- A Professional Engineer is required to determine the appropriate size of tank required.

5. Gravity Bag Filters



Photo source: U.S. Filter Bags

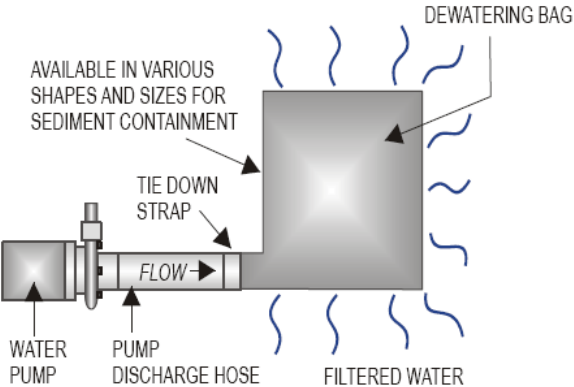

Graphics Source: CASQA

- A gravity bag (or “dewatering bag”) is a rectangular bag made of geotextile fabric designed to remove sand, silt, and fines from discharged water.
- Water is pumped into the bag and seeps through the material composing the body of the bag.
- The gravity bag filter is used in conjunction with a secondary containment device such as a rock filter bed barrier to capture sediments escaping the bag.
- The bag must be inspected at regular intervals and replaced when it fails to remove sediment.
- The gravity bag filter is only applicable for small-scale dewatering projects.

6. Sand Media Particulate Filter



- Water is pumped through canisters filled with sand filtration media.
- These can be used for stand-alone treatment or as a secondary treatment method following a sediment trap or basin.
- Effective for removal of trash, gravel, sand, and silt, and reduction of metals, BOD and turbidity.
- Vendors are available to deliver sand filter units to construction sites and assist with set-up and operation.
- Service units at least monthly to ensure proper function.

7. Pressurized Bag Filter.



- Discharged water is forced through pressurized polyester filter bags.
- Such units can be set up in a variety of configurations, depending upon site requirements. Often including cartridge filters for enhanced treatment.
- Effective for removal of trash, gravel, sand, and silt, and reduction of metals, BOD and turbidity. Oil absorbent bags are available for oil and grease removal.
- These can be used for stand-alone treatment or as a secondary treatment method following a sediment trap or basin.
- Vendors are available to deliver bag filter units to construction sites and assist with set-up and operation.
- Service units regularly to ensure proper function.



8. Cartridge Filter

- Cartridge filters combine a number of individual filters for an enhanced level of water treatment.

Dewatering Operations

GM-4

- Effective for removal of trash, gravel, sand, and silt, and reduction of metals, BOD and turbidity. Resin cartridges are available for oil and grease removal.
- Often used in series with sediment traps or basins for pre-treatment.
- Vendors are available to deliver bag filter units to construction sites and assist with set-up and operation.
- Service units regularly to ensure proper function.

Street & Surface Cleaning

GM-5



Map Symbol

Graphics used with permission of Caltrans

Purpose: To remove sediment tracked onto pavement and to prevent it from entering the storm drain system.

Applications:

- Any location where sediment is tracked from a private construction site onto paved roads.
- Any other surfaces receiving wash-down related to construction activities, including sidewalks, driveways, parking areas, storage areas, and building exteriors.

Limitations:

- Wet soil or mud may not allow for effective sweeping.

Standards and Specifications:

- Follow the policies stated in Standard No. 1 of the Construction Permit Submittal Checklist (Appendix D).
- Follow all applicable District Health dust control standards.

Inspection and Maintenance:

- Daily inspection of potential sediment tracking locations.
- Daily inspection of egress/ingress access points.
- Follow this general cleaning procedure:
 1. Use absorbents to pick up oil, as needed,
 2. Use dry sweep up to remove debris, and

3. Wash surfaces avoiding the use of detergents.
 - Daily sweeping and vacuuming of visible sediment tracking.
 - Block/cover storm drain inlets, and contain wash water runoff when washing streets.
 - Do not sweep up any potentially hazardous materials or objects.
 - If detergents are used, or wash water contains pollutants such as petroleum, grease, food waste, garbage and paint chips, it shall be disposed of in the sanitary sewer system provided approved pretreatment device is used, and permission is granted by the local authority.
 - If detergents are NOT used, and the wash water is sufficiently clear of pollutants such as petroleum, grease, food waste, garbage, paint chips, and sediment (i.e. dry sweep up occurred before washing) the water may be discharged to the storm sewer system.
 - Adjust brooms on sweeper frequently to maximize efficiency.
 - Proper disposal of sweeper waste is necessary – dispose of waste at the regional landfill.

Spill Prevention & Control

GM-6

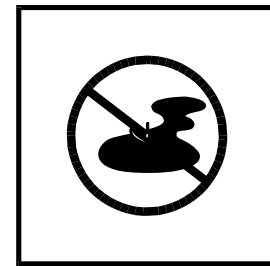
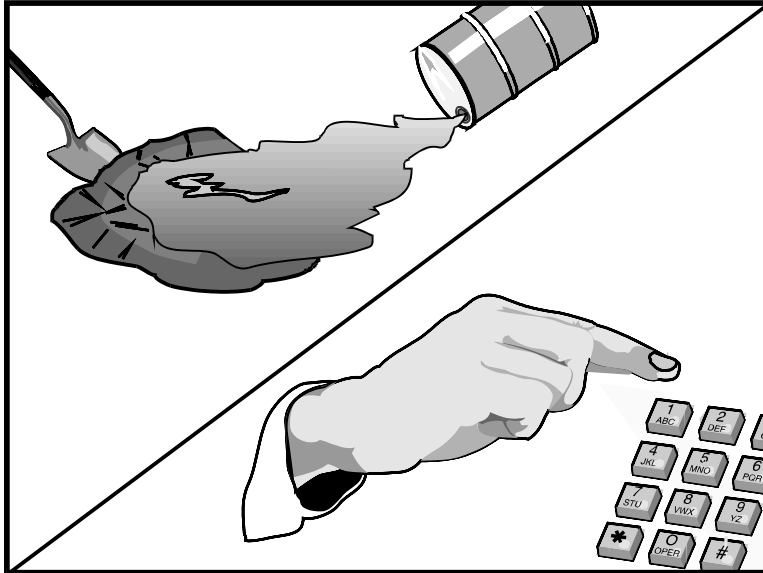

Map Symbol

Graphics used with permission of Caltrans

Purpose: Discharges of non-hazardous and hazardous materials to the storm drain system can be minimized or eliminated by preventing and controlling spills through defined procedures and practices.

Applications:

- Applies to all construction sites.
- Implemented any time chemicals are used (including fuel areas).
- Chemicals include (but are not limited to): soil stabilizers, dust palliatives, herbicides, growth inhibitors, fertilizers, deicing chemicals, fuels, paints, solvents, cement, lubricants, and other petroleum distillates.

Limitations:

- The described practices are general and therefore should be adjusted by the contractor for the specific materials used or stored on-site.
- Applies only to spills caused by the contractor or others on-site.

Standards and Specifications:

- Do not bury or wash spills with water.
- Attempt to cover spills during rainfall events as long as cleanup efforts are not compromised.
- Do not allow water used for cleanup purposes to enter the storm drain system.

- Keep waste storage areas clean, well-organized, and well equipped.
- Post information on proper storage, clean up and spill response at a visible and accessible location at all times.
- Educate employees and subcontractors about what a “significant” and “insignificant” spill is for each chemical used on-site and train in spill prevention and cleanup. – See project specific Spill Prevention Control and Countermeasure Plan (SPCC Plan).
- Hold regular meetings to discuss and reinforce disposal procedures (incorporate into regular safety meetings).
- Locate chemical storage and handling areas away from storm drains, waterways, or reservoirs.
- Do not store chemicals in areas where they may be susceptible to rain.
- Provide a secondary containment structure in case of leaks or spills.
- Always use a secondary containment, such as a drain pan or drop cloth, to catch spills or leaks when removing or changing fluids.
- Place drip pans or absorbent material under paving equipment when not in use.
- Promptly transfer used fluids to the proper waste or recycling drums. Do not leave full drip pans or other open containers lying around.
- Oil filters disposed of in trashcans or dumpsters can leak oil and pollute storm water. Place the oil filter in a funnel over a waste oil-recycling drum to drain excess oil before disposal.
- Store cracked batteries in a non-leaking secondary container.
- If vehicles will be fueled on site:
 - Discourage “topping off”.
 - Use designated areas located away from waterways and drainages.
 - Use a secondary containment to catch drips or spills.
- Place a stockpile of spill cleanup materials where it will be readily accessible.
- Clean up spills immediately and dispose of contaminated soils and clean up materials properly.
 - Sweep up dry spills. Do not wash or hose down the area.
 - Use absorbents for wet spills on impermeable surfaces.
 - Wet spills on soils require digging up and disposing of the contaminated soil.
- A secondary containment with enough capacity to contain a spill is required for fueling areas.

Spill Prevention & Control

GM-6

- Report significant spills to local and state agencies, such as the City of Sparks Environmental Control (775-691-9227), the City of Reno Environmental Control (775-334-4636), Washoe County District Health (775-328-2436), and NDEP (888-331-6337), who may assist in the cleanup.
- Federal regulations require that any significant oil spill into a water body or onto an adjoining shoreline be reported to the National Response Center (NRC) at 800-424-8802 (24 hours).
- Only a reputable, licensed company should be used to clean up large spills and dispose of contaminated materials.

Inspection and Maintenance:

- On a weekly basis, ensure that an adequate supply of spill control cleanup materials are located close to storage, fueling, and unloading areas.
- Inspect containment structures in fueling and storage areas.
- Update spill prevention plans when the types of chemicals stored on site changes.
- Regularly inspect on-site vehicles and equipment for leaks, and repair them immediately.

Vehicle & Equipment Cleaning

GM-7

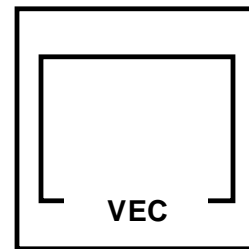
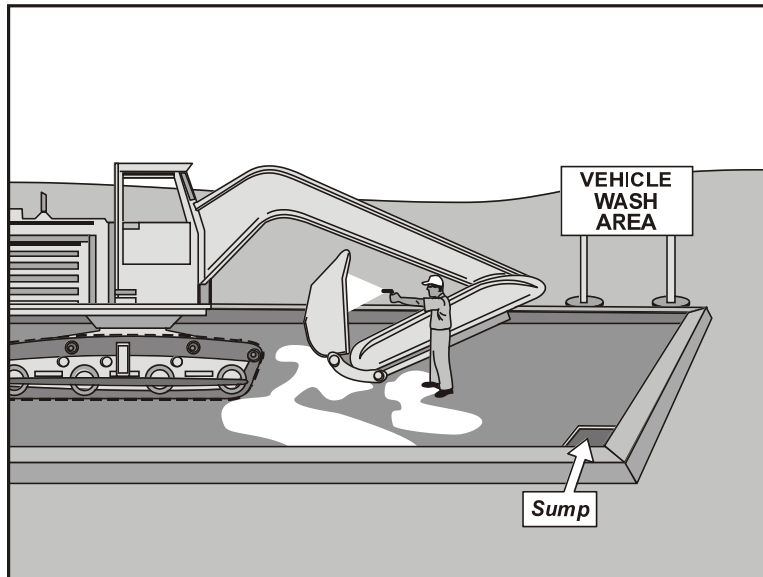

Map Symbol

Graphics used with permission of Caltrans

Purpose: To minimize or eliminate the discharge of pollutants entering the storm drain system from vehicle and equipment cleaning operations on construction sites.

Applications:

- All construction sites where vehicle cleaning occurs.

Limitations:

- Wash water discharges may need to be pretreated before release into the sanitary sewer.

Standards and Specifications:

- Onsite vehicle and equipment washing is discouraged.
- Do not clean vehicles and equipment with detergent, solvents or steam on the project site.
- Contain wash water away from storm drain inlets or waterways for evaporative drying or percolation.
- Off-site cleanings are required for all vehicles and equipment that regularly enter and leave the construction site.
- Conduct washing, fueling, and major maintenance offsite whenever possible.

Vehicle & Equipment Cleaning

GM-7

- In the event that outside cleaning must occur onsite:
 - Locate cleaning area away from storm drain inlets, drainage facilities, or waterways.
 - Pave the area with concrete or asphalt, create a berm to contain wash waters and prevent run-on or runoff.
 - Install a sump to collect wash water.
 - Do not discharge wash waters to storm drains or waterways.
 - Use only when necessary.
- When cleaning vehicles with water:
 - Consider using a high-pressure sprayer or a positive shutoff valve to reduce water usage.

Inspection and Maintenance:

- Minimum once per week inspection of the control measure.
- Monitor employees and subcontractors to ensure that proper practices are being implemented.
- Regular inspection and maintenance of the sump. Remove sediments and liquids as needed and dispose of properly.

Vehicle & Equipment Maintenance & Fueling

GM-8

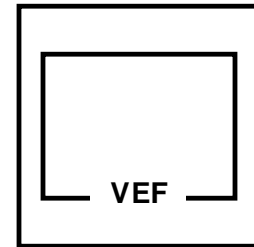
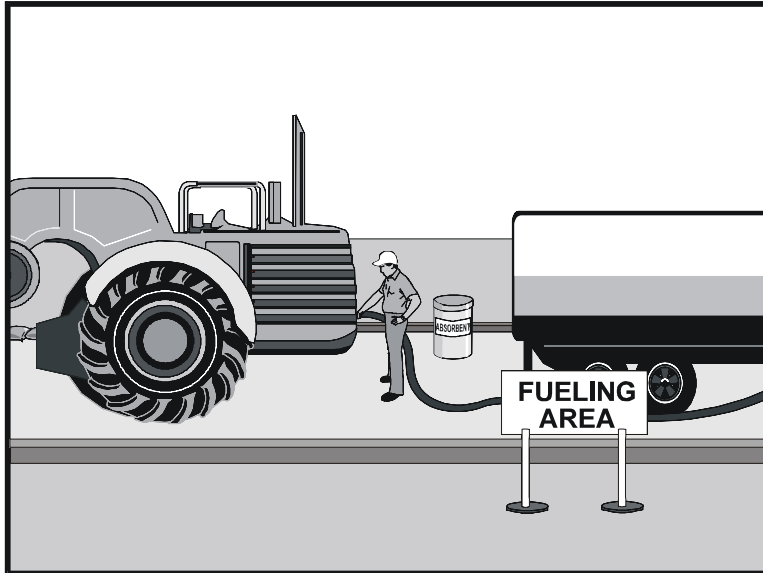

Map Symbol

Graphics used with permission of Caltrans

Purpose: To minimize or eliminate the discharge of fuel spills and other pollutants into the storm drain system on construction sites.

Applications:

- All construction sites where storage and maintenance of heavy equipment and vehicles occurs on-site.
- Fueling areas on all construction sites.

Limitations:

- Fuel vehicles on-site only when off-site fueling is impractical.
- Comply with local codes regarding fluid disposal and onsite equipment maintenance.

Standards and Specifications:

- Provide spill cleanup kits in fueling areas and on fueling trucks. Proper disposal is required.
- Use a drip pan or absorbent pad unless fueling or conducting maintenance activities occur over an impervious surface.

Vehicle & Equipment Maintenance & Fueling

GM-8

- Place a drip pan or sheet under vehicles when they are located over a water body (e.g. on a dock or a barge) and they will be idle for more than one hour (refer to fact sheet GM-20 for additional information).
- Fueling areas:
 - Locate at least 100 feet from waterways, channels and storm drains.
 - Protect from run-on and runoff by elevating or berming and covering the fueling area.
 - Located on a level-graded area.
 - Attend at all times during fueling.
- Equip fueling equipment with automatic shut-off nozzles to contain drips.
- Do not “top-off” fuel tanks.
- Avoid mobile fueling.
- Observe federal, state, and local requirements relating to any above ground storage tank.
- Provide secondary containment for fuel tanks and other containerized hazardous materials. The volume of the secondary containment area shall be at least 1.5 times the volume of the primary container.
- Do not dump fuels and lubricants on the ground.
- Do not bury used tires.
- Do not dispose of oil in a dumpster or pour it down the storm drain.
- Properly dispose of used batteries.
- Conduct washing, fueling, and major maintenance offsite whenever possible.
- Inspect vehicles for leaky hoses, gaskets, or other problems.
- Locate vehicle services areas away from waterways, storm drains, gutters, and curbs.
- Use berms, sandbags, or other barriers to contain areas.
- Do not use detergents, solvents, degreasers, or other chemical products to do on-site cleaning.
- Use a drip pan or drip cloth if fluids will be drained and replaced on-site.
- Collect all used fluids, store in separate labeled containers, and either recycle or dispose of properly.

Vehicle & Equipment Maintenance & Fueling

GM-8

Inspection and Maintenance:

- Inspect on all containment structures.
- Maintain waste fluid containers in a leak proof condition.
- Service sumps associated with wash areas regularly.
- Inspect daily for leaks on vehicles and equipment.
- Keep an ample supply of spill cleanup materials available onsite.
- Clean up spills immediately and dispose of waste properly.
- Prevent boil-overs by regularly cleaning equipment radiators.

Handling & Disposal of Concrete & Cement

GM-9

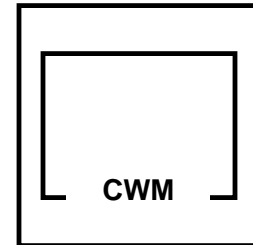
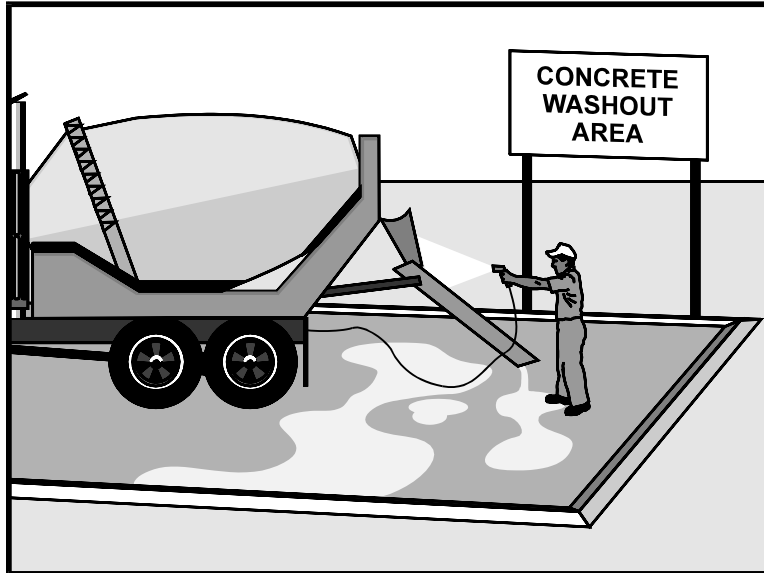

Map Symbol

Graphics used with permission of Caltrans

Purpose: To prevent pollution from concrete and mortars by providing a designated washout area for trucks, tools, and mortar mixers.

Applications:

- For the storing of wet and dry concrete and cement mortar materials.
- For the on-site preparation of concrete and cement mortars.
- Washing out of concrete equipment on-site.

Limitations:

- Site may constrain location of an appropriate wash out area.

Standards and Specifications:

- Educate all employees and subcontractors on concrete waste management.
- Collect and dispose of properly all Portland Cement Concrete (PCC) and asphalt concrete (AC) waste so that it does not enter the storm drain system.
- Post a sign next to the temporary concrete washout areas.
- Concrete washout facilities can be designed above or below grade. Below grade facilities are preferred.
- Collect and dispose of properly all slurry residues.

Handling & Disposal of Concrete & Cement

GM-9

- Place a berm around concrete washout facilities to prevent runoff from entering below grade pits.
- Determine the capacity of concrete washout facilities based on the estimated amount of concrete washout waste to be generated at site. The volume must also be designed to contain any runoff that drains to the facility and the rain falling directly into the facility during the 2-yr, 24-hr storm event.
- Concrete washout facilities shall be used only to temporarily contain washwater from the cleaning of concrete-coated equipment and washout from concrete trucks.
- Concrete washout facilities shall not be used for the disposal of excess concrete and cement and trucks shall not be allowed to back turn and dispose of residual loads.
- Concrete washout facilities must be lined to prevent chemical transport into nearby waters or groundwater.
- Locate concrete washout areas a minimum of 50 feet from waterways and the storm drain system.
- Mix only an appropriate amount of fresh concrete or cement mortar.
- Store materials away from waterways or storm drains.
- Perform wash out activities in the designated areas.
- Concrete Washout – The operator shall provide an effective means of eliminating the discharge of water from the washout of concrete;
 - Where possible, concrete suppliers should conduct washout activities at their own plants or dispatch facilities.
 - If washout is conducted at the construction site, the operator shall employ control measures (e.g., lined pits or portable washouts) to contain and manage on-site concrete washout to prevent discharge.
 - The pit or container must be designed so that no overflows can occur due to inadequate sizing or precipitation.
 - Remove and dispose of hardened concrete consistent with handling of other construction waste materials.

Inspection and Maintenance:

- Dispose of wastes at least once per week.
- When the washout is 75 percent full, it must be cleaned or a new washout must be constructed.

Material Delivery, Handling, Storage & Use

GM-10

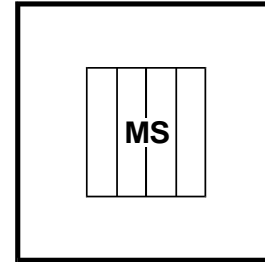
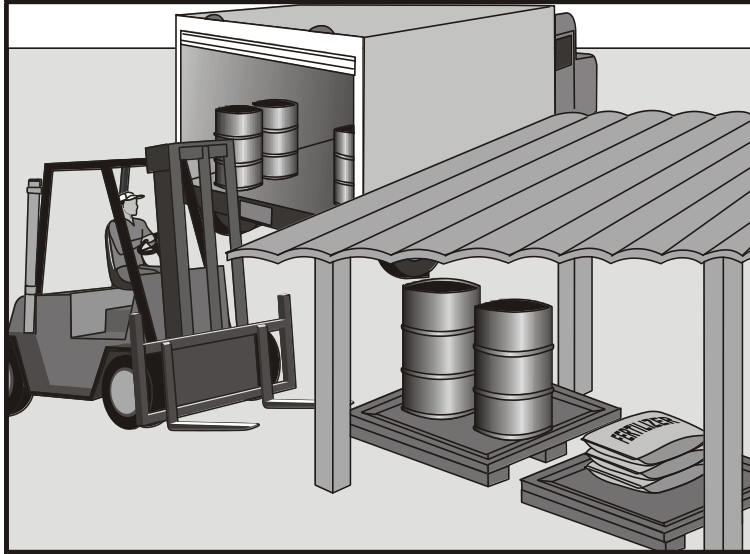

Map Symbol

Graphics used with permission of Caltrans

Purpose: To minimize or eliminate the discharge of hazardous or non-hazardous materials to storm drains, watercourses, or drainage channels.

Applications:

- All construction sites that have delivery and storage of:
 - Fuel, oil, grease
 - Herbicides, pesticides, fertilizers, soil amendments, inoculants
 - Asphalt, concrete and their components
 - Acids, curing and form compounds
 - Other hazardous materials

Limitations:

- All temporary storage buildings must meet building codes.
- Storage must meet fire codes.
- Remove all temporary secondary containment structures and materials from the site upon completion of the project and dispose of according to regulations.

Material Delivery, Handling, Storage & Use

GM-10

Standards and Specifications:

- Designate a storage area that is not near a storm drain or watercourse.
- All contractors and subcontractors must train employees in proper materials handling, storage, application and delivery procedures.
- Follow manufacturers' instructions on application, storage and disposal of materials.
- Store onsite only the amount of material necessary for the job.
- Use non-hazardous and environmentally friendly products whenever possible.
- Provide indoor storage or cover stockpiled materials and wastes with a tarp.
- Provide covered storage for secondary containment of hazardous materials.
- Cover top and sides of stored materials to prevent rain and snow contact, and runoff.
- Use secondary storage to prevent soil contamination.
- Monitor employees and subcontractors to ensure that proper practices are being implemented.
- Keep all material in original containers.
- Label all stored materials according to state, local and federal regulations.
- Do not store incompatible materials together.
- Keep adequate supply of cleanup materials on site at all times.
- Report all spills.
- Do not apply hazardous chemicals during wet or windy conditions.

Inspection and Maintenance:

- Inspect storage areas weekly to ensure neatness.
- Post proper storage instructions and Material Safety Data Sheets (MSDS) for all currently stored materials.
- Repair and replace damaged secondary containment facilities.
- Remove all empty containers and packaging from site.
- Store materials with adequate clearances for access and emergency response.

Paints & Liquid Materials

GM-11

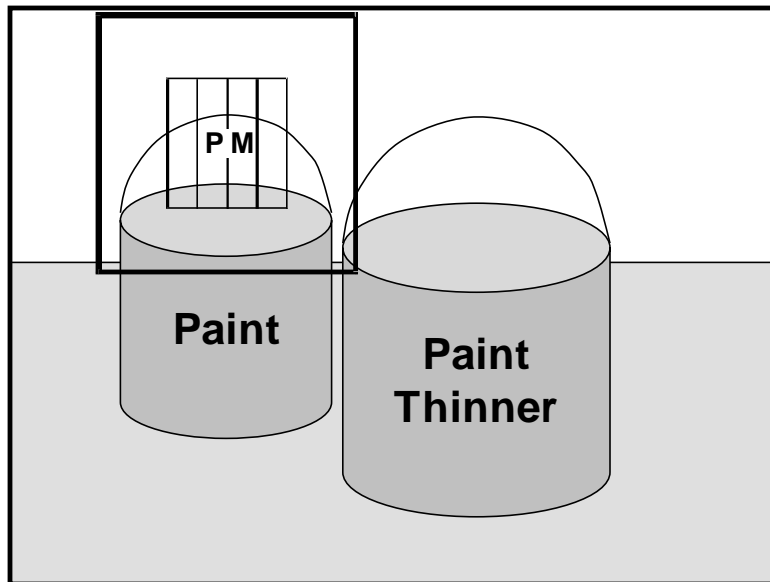

MAP SYMBOL

Graphics produced by Kennedy/Jenks Consultants

Purpose: To minimize or eliminate the discharge of hazardous or non-hazardous paint wastes, adhesives, solvents and cleaning products to storm drains, watercourses and drainage channels.

Applications:

- Hazardous residues from paints, thinners, solvents, cleaning agents.
- Non-hazardous materials such as paint cans, brushes, rags, drop cloths.
- Paint removal wastes such as chemical stripping residues, paint chips, sand blasting material and wash water.

Limitations:

- Hazardous wastes must be either recycled or disposed of by a licensed hazardous waste hauler.
- Storage must meet Fire Codes.

Standards and Specifications:

- Designate specific storage and cleaning areas.
- Use non-hazardous and environmentally friendly products when possible.
- Do not clean brushes or rinse containers near storm drains, watercourses or drainage channels.
- Keep all paints, liquids and wastes away from gutters, storm drains, watercourses and drainage channels.
- Sweep up non-hazardous sand blasting residue and paint chips. Dispose of these wastes in the garbage.

- Dispose of old brushes, rollers, and dried latex paint in the garbage.
- Test pre-1970 paint for lead. Follow regulations if lead is present.
- Dispose of non-recyclable oil based or other products as hazardous waste.
- Dispose of as hazardous waste all residues, paint chips, or dust which contain lead or tributyl tin.
- Recycle empty, dry paint cans if possible.
- Paint out water based paints out of brushes as much as possible before rinsing them in an area that drains to the sanitary sewer.
- When water blasting and stripping building exteriors, cover or berm storm drain inlets to prevent waste from entering gutters, storm drains, watercourses and drainage channels. If appropriate, dispose of wastewater in the sanitary sewer.

Inspection and Maintenance:

- Monitor employees and subcontractors to ensure that proper practices are being implemented.

Pavement Construction Management GM-12

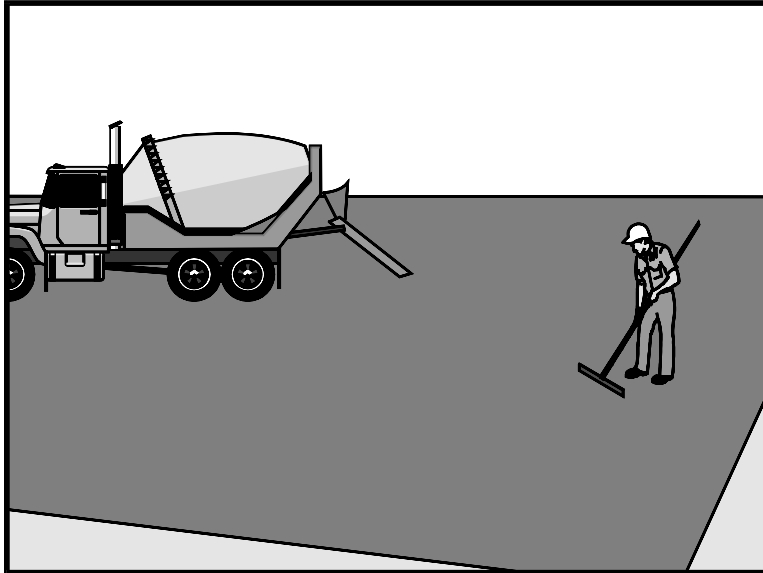

Map Symbol

Graphics used with permission of Caltrans

Purpose: To minimize or eliminate the discharge of on-site paving, surfacing, cutting, or installing asphalt or concrete materials to storm drains, gutters or water courses.

Applications:

- Application of concrete, asphalt, seal coats, tack coats, slurries etc.
- Application of thermoplastic striping and pavement markers.
- Pavement recycling operations.
- Storage of paving equipment.
- Saw cutting and saw cutting residue.
- Removal of existing concrete or asphalt.

Limitations:

- Do not apply materials in rainy or inclement weather that would allow materials to come into contact with storm water.

Standards and Specifications:

- Protect drainage ways and storm drains and divert or capture runoff from seal coats, tack coats, slurry or fog seals. Gather and properly dispose of trapped material. Do not allow runoff or trapped materials from these surfaces to enter the storm drain system.
- Substances used to coat asphalt trucks and equipment shall not contain detergent and shall be non-foaming and nontoxic.
- Minimize the washing of sands, gravels and asphalt from paving, sealing, grinding or coating operations into storm drains, watercourses and drainage channels.

Pavement Construction Management GM-12

- Dispose of spilled oil and asphalt off site according to all state, local and federal regulations.
- Do not clean paving equipment on site.
- Use as little water as possible during saw cutting operations.
- Do not allow saw cut slurry to enter storm drains, watercourses or drainage channels. Provide labor to utilize a push broom behind the saw cutting operation to keep fines accumulated in one area. Gather and remove wastes from the site at the end of the day (see GM-3 and GM-5)
- Remove asphalt from digouts, grinding and leveling operations from the site and dispose of according to local, state and federal regulations.
- Collect saw cutting slurry as generated.
- Contain all water and solid waste from high pressure water blasting operations (concrete finishing) and dispose of properly.
- If performing concrete finishing/saw cutting operation in the vicinity of storm drain inlets, be sure that all inlets are protected and prevent wash water from entering the storm drain system.
- If sandblasting is used to finish surfaces, contain the area by hanging plastic sheets or equivalent to prevent material from leaving the site.
- If chemical compounds are used to cure concrete, these chemicals must be used conservatively to avoid any runoff. Handle appropriately, according to BMP fact sheet GM-10 "Material Delivery, Handling, Storage and Use".

Inspection and Maintenance:

- Monitor employees and subcontractors to ensure that proper practices are being implemented.
- Park paving equipment over drip pans or absorbent material. Dispose of waste properly.
- Repair leaking machinery.
- Inspect inlet protection devices both before and after storm events. Check devices daily during extended storm events.
- Do not allow storm water to back up into active traffic areas.

Liquid Waste Management

GM-13

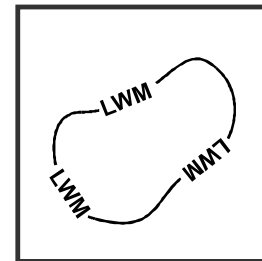
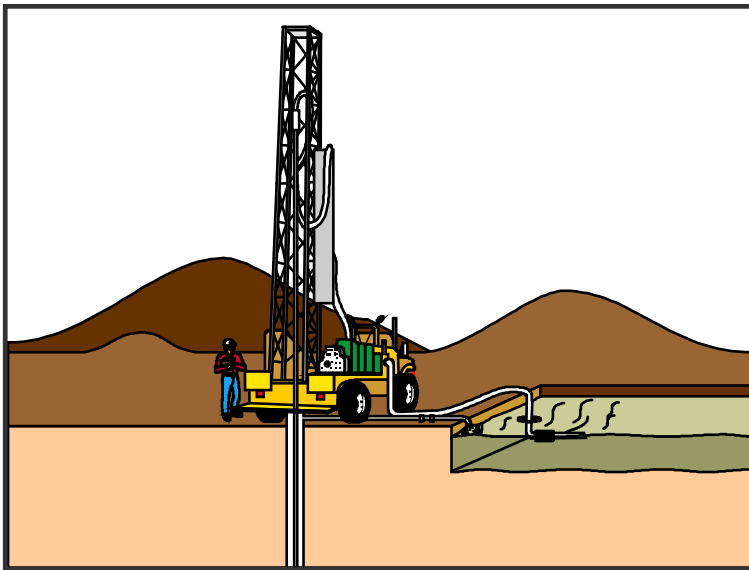

Map Symbol

Graphics used with permission of Caltrans

Purpose: To minimize or eliminate the discharge of on-site generated non-hazardous liquid waste to storm drains, gutters, watercourses and drainage channels.

Applications:

- Drilling slurries and fluids.
- Dredgings.
- Grease-free and oil-free wash waters.

Limitations:

- Disposal of some wastes may be subject to specific permitting requirements (NDEP or the U.S. Army Corps of Engineers). Testing of dredging wastes may be necessary before a disposal method can be determined.
- Not applicable for dewatering, line flushing, landscape irrigation, or diverted stream flows.
- Not applicable to foundation drains, crawl space dewatering, or discharges from emergency firefighting.

Standards and Specifications:

- Protect drainage ways with earth dikes, filter fabric, sand bags etc. to divert or capture run off from operations. Gather and dispose of trapped material properly.
- Educate workers on how to identify a non-hazardous from a hazardous liquid waste.

- Educate workers that it is unacceptable to have any liquid waste enter storm drains, gutters or watercourses and drainage channels. Incorporate in safety meetings.
- Store and contain wastes in pits or portable tanks that are large enough to completely contain wastes. Locate where accidental discharge will not follow to storm drains, gutters, watercourses and drainage channels.
- If necessary, treat wastes by filtrations, sedimentation or chemical neutralization before disposal.

Inspection and Maintenance:

- Monitor employees and subcontractors to ensure that proper practices are being implemented
- Remove deposited solids from containment areas and capturing devices. Dispose of offsite according to all local, state and federal regulations.
- Inspect containment areas and capturing devices for damages and leaks. Repair or replace as needed.

Sanitary/Septic Waste Management GM-14

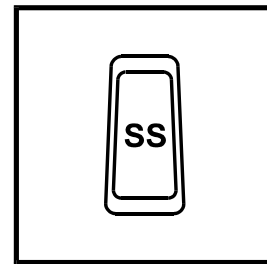
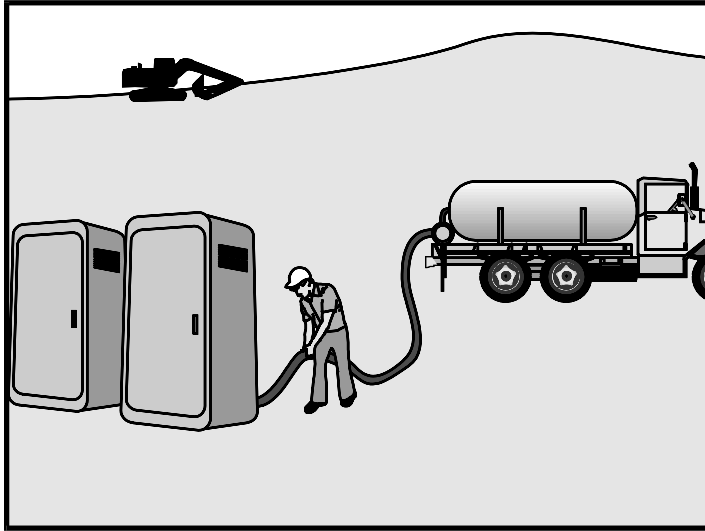

Map Symbol

Graphics used with permission of Caltrans

Purpose: To minimize or eliminate the discharge of sanitary wastes from construction sites to storm drains, gutters, watercourses and drainage channels.

Applications:

- Applies to construction sites that have portable or temporary sanitary waste systems.

Limitations:

- To dispose of wastes to the sanitary sewer, the leasing company must be permitted.
- On-site disposal systems must comply with all local and state regulations.
- Temporary connections to the sanitary sewer must meet local and state codes and regulations.

Standards and Specifications:

- Locate portable toilets where accidental discharge cannot flow to storm drains, gutters, watercourses and drainage channels.
- If unable to locate on a pervious site and toilet is parked on pavement, use appropriate straw wattles or other effective BMPs to prevent storm water contamination.
- Locate portable toilets on bare soil (not on pavement) and anchor them so they do not overturn during high winds (stake them down).
- All sanitary wastes must eventually be discharged to a sanitary sewer.
- Educate workers on the potential harm to the environment from sanitary wastes.
- Employ licensed sanitary services to ensure facilities are in working order at all times.

Inspection and Maintenance:

- Monitor employees and subcontractors to ensure that proper practices are being implemented.
- Inspect sanitary storage and disposal facilities at least once per week. Properly maintain, repair, or replace units as needed.

Landscaping Management

GM-15

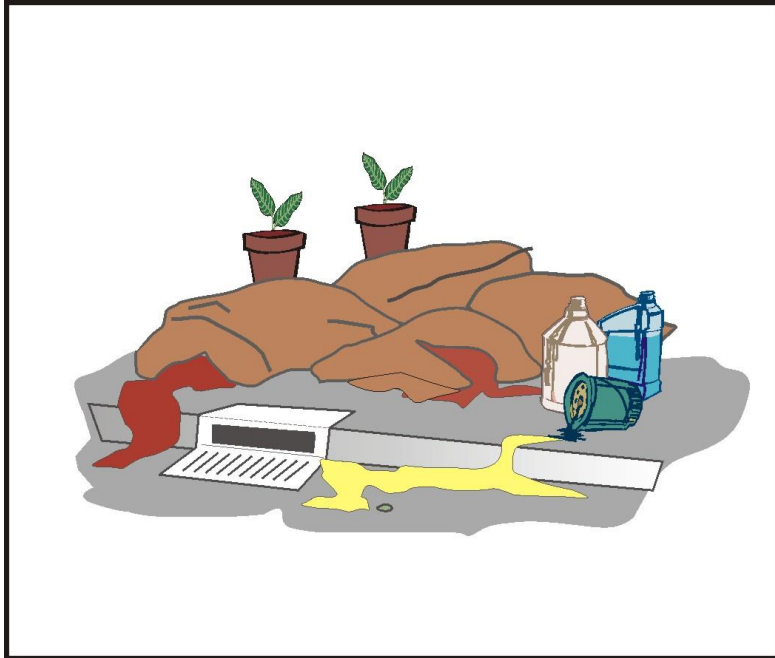

Graphics produced by Kennedy/Jenks Consultants

Purpose: To minimize or eliminate the discharge of soils, fertilizers and chemicals that are used in landscaping to storm drains, gutters, watercourses and drainage channels.

Applications:

- Preparation of soils for landscaping.
- Planting of trees, shrubs, grasses and other vegetation.
- Use of fertilizers, pesticides and herbicides.

Limitations:

- None have been identified.

Standards and Specifications:

- Use plants and grasses that are non-invasive, pest resistant and drought tolerant when possible to minimize chemical use and labor.
- Use tarps to protect stockpiled soils and landscaping materials from rain or snow contact.
- Schedule grading and trenching activities during dry weather. Avoid these practices during windy weather and apply dust control methods as necessary.
- Use earth dikes, filter fabric, or sand bags to divert or capture runoff from entering storm drains, gutters, watercourses and drainage channels.

Landscaping Management

GM-15

Inspection and Maintenance:

- Minimize the amount of chemicals applied to the site. Store only enough to complete the job and remove all empty storage containers from the site. Properly dispose of the empty containers.
- Attempt to use less toxic alternatives.
- Inspect areas after planting. Replace dead grass, trees and shrubs.
- Add erosion control where necessary to prevent and stop erosion.
- Minimize water runoff from landscape.
- Stockpiles shall not be stored in the right of way overnight. If stored more than 1 day on concrete, BMPs must be used to prevent storm water contamination.

Contaminated Soil & Water Management

GM-16

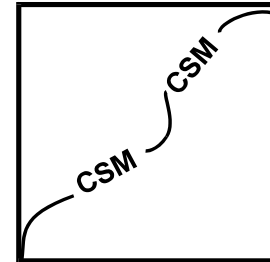
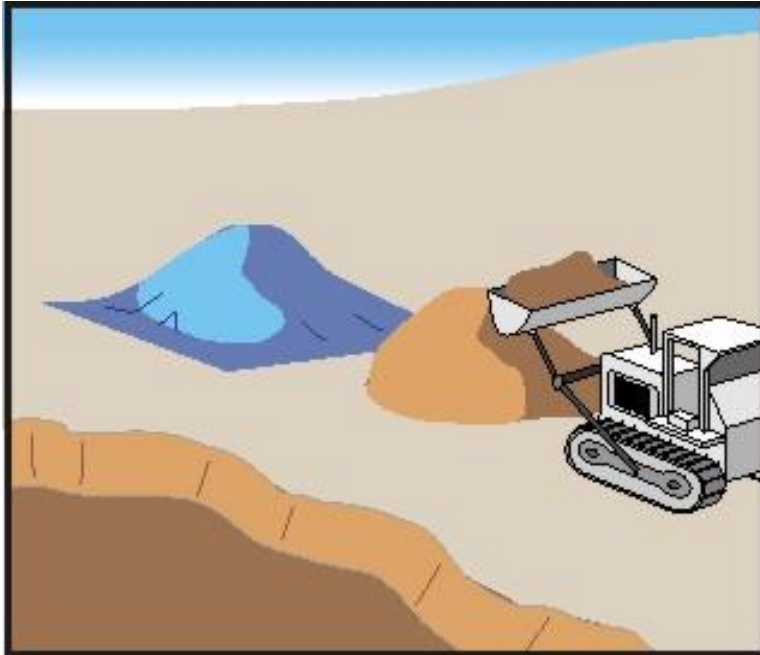

Map Symbol

Graphics produced by Kennedy/Jenks Consultants

Purpose: Minimize or eliminate the discharge of contaminated soil or water to storm drains, gutters or watercourses and drainage channels.

Applications:

- Areas of previous industrial and transportation activity.
- Sites where illegal dumping has occurred.
- Sites subject to cleanup orders.
- Sites where spills of petroleum products, herbicides, pesticides, other hazardous materials or chemicals have occurred.
- Sites where abandoned drums, tanks or contaminated soils are encountered during new construction.
- Ponded water standing over 48 hours may breed mosquitoes and midges.

Limitations:

- Once contamination is encountered in the field, treatment and disposal methods have to be determined.
- Federal, state, and local regulations must be followed when excavating, transporting, and disposing of contaminated materials.

Contaminated Soil & Water Management

GM-16

Standards and Specifications:

- Call the appropriate agency for guidance when contamination is suspected (Washoe County Environmental Health 775-328-2436).
- Review applicable reports and investigate the call-outs when contamination is identified on the plans.
- Never allow materials to discharge to storm drains, gutters, watercourses and drainage channels.
- Avoid stockpiling contaminated soil on site. Cover the stockpiles with tarps to prevent wind erosion. Install dikes around the stockpiles to prevent site runoff. Do not locate stockpiles close to storm drains, gutters, watercourses and drainage channels.
- Install temporary fencing to prevent unauthorized entry.
- Treat and dispose of waters collected from decontamination procedures at appropriate sites.
- Collect non-reusable protective equipment and dispose of at appropriate disposal sites.
- Install dikes around the site to prevent storm water from entering or leaving the site.
- Treat and properly dispose of all water that has come into contact with contaminated materials.

Inspection and Maintenance:

- Inspect sites prior to and during construction to note any odd odors, different colors in soils, other unusual properties of the soil and water and exposed drums or tanks.
- Educate employees and subcontractors in identification and handling of contaminated soils. Check to make sure proper procedures are followed.
- Train employees in newest procedures for handling materials. Update when new information is available.
- Monitor site for air and water quality during cleanup.

Hazardous Waste Management

GM-17

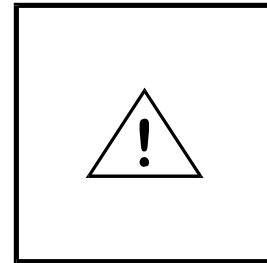
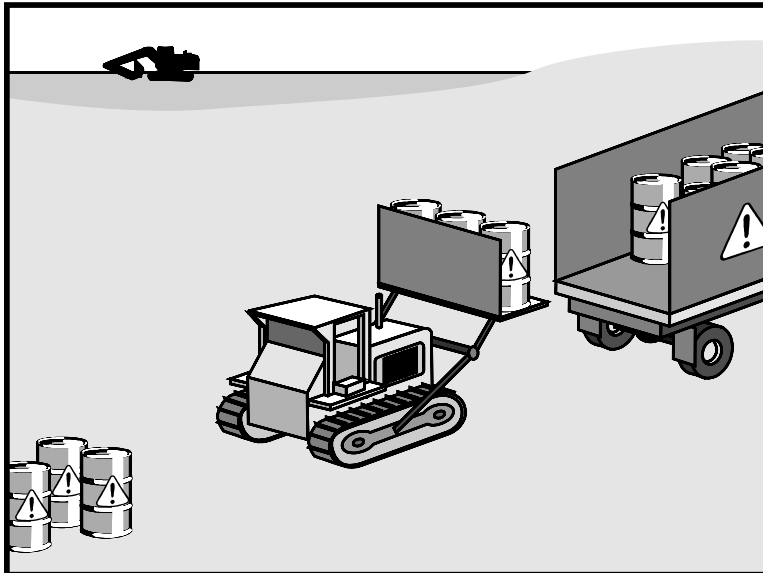

Map Symbol

Graphics used with permission of Caltrans

Purpose: To minimize or eliminate the discharge of hazardous wastes from construction sites to storm drains, gutters, watercourses and drainage channels.

Applications:

- Petroleum products
- Asphalt and concrete products
- Herbicides and pesticides
- Acids for cleaning masonry
- Soil stabilization chemicals
- Septic wastes
- Paints, solvents, stains and wood preservatives
- Materials that were used to treat or adsorb other wastes
- Hazardous construction wastes such as lead, asbestos, or lead paint

Limitations:

- Does not address pre-existing contamination or site assessments.
- Large spills or other serious hazardous wastes require immediate response from specialists.
- Contractor is required to follow all federal, state and local laws regarding handling, storing, and transporting waste materials.

Standards and Specifications:

- Contact Washoe County Environmental Health (775) 328-2436 regarding local hazardous waste management policies and procedures.
- Waste containers shall be constructed of a suitable material and properly labeled according to regulations. Labels must include type of material, time of collection and site location.
- Size temporary containment for stored materials at least 1.5 times the volume of the stored material. Materials must be stored in sealed drums.
- Temporary containment areas shall be free of accumulated storm water and spills.
- Temporary containment areas shall have room between containers for emergency response and cleanup.
- Incompatible materials shall be stored separately.
- Do not store different materials in the same container.
- Do not locate temporary containment areas near storm drains, gutters, watercourses or drainage channels.
- Provide adequate access to temporary containment areas.
- Store containers on pallets under a covered, protected area unless containers are water tight.
- Do not dispose of liquid waste in dumpsters or other solid waste containers.
- Collect water from decontamination procedures, treat it and dispose of it at an appropriate disposal site.
- Educate employees and subcontractors in waste storage and disposal. Ensure that proper procedures are followed.
- Train employees in newest procedures for handling materials. Update when new information is available.
- Immediately repair all dikes and liners used for storage or containment.
- Recycle materials if appropriate.

Inspection and Maintenance:

- Ensure that all wastes are properly labeled and stored.
- Verify that all hazardous wastes are disposed of properly.
- Hazardous wastes must be collected, labeled and disposed of at authorized disposal sites.
- Keep supplies on site for cleanup of spills.
- Post MSDS sheets for all materials stored on site.
- Immediately repair all dikes and liners used for storage or containment.

Illicit Discharges & Connections Detection & Reporting

GM-18

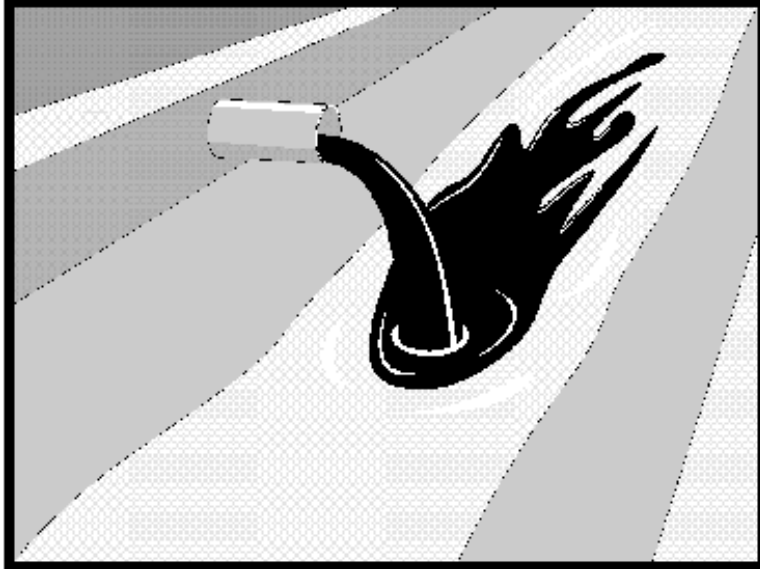

Map Symbol

Graphics used with permission of Caltrans

Purpose: To recognize and report illegal dumping, discharge or illegal connection to the storm drainage system facilities.

Applications:

- Applies to all construction sites.
- Anytime an illicit discharge, connection or illegally dumped material is discovered on the construction site.

Limitations:

- Any unlabeled, unidentifiable dumped material is assumed to be hazardous.
- This BMP refers to discharges, connections or dumping done by someone other than the contractor.

Standards and Specifications:

- Look for debris and rubbish piles.
- Look for staining or unusual colors on pavements or soils.
- Look for strange smells from the soil or from the drainage and dewatering systems may indicate illegal dumping or connections.
- Look for excessive sediment deposits in ditches that may indicate illegal flows during non-work hours.

Illicit Discharges & Connections GM-18

Detection & Reporting

- High flows in drainage or dewatering systems may indicate illegal connections.
- Unusual colors on standing water, in drainage structures, or in ditches may indicate illegal connections or dumping.
- Report any illegal dumping, discharges or connections to local and state agencies, such as the City of Sparks Environmental Control (775-691-9227), the City of Reno Environmental Control (775-334-4636), Washoe County District Health (775-328-2436), and NDEP (888-331-6337), who may assist in the cleanup.
-

Inspection and Maintenance:

- Inspect the construction site prior to starting any work in order to identify any illegally dumped material.
- Inspect the perimeter of the site for illegally dumped materials that may enter the job site.

Drilling & Pile Driving Operations GM-19

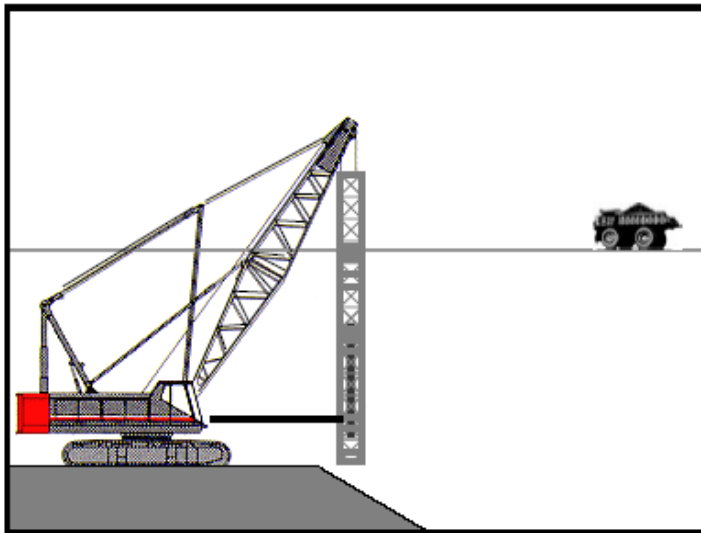

Graphics used with permission of NDOT

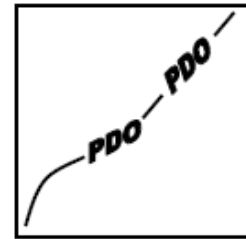

- | BMP Objectives | |
|----------------------------------|--------------------------------|
| <input type="radio"/> | Soil Stabilization |
| <input type="radio"/> | Sediment Control |
| <input type="radio"/> | Tracking Control |
| <input type="radio"/> | Wind Erosion Control |
| <input checked="" type="radio"/> | Non-Storm Water Management |
| <input checked="" type="radio"/> | Materials and Waste Management |

Purpose: Drilling and pile driving operations employ specialized equipment and materials including drilling fluid. Proper control and use of the equipment, materials, and waste products from drilling and pile driving operations will reduce the discharge of potential pollutants to the storm drain system or watercourses.

Applications:

- Construction sites near or adjacent to a watercourse where permanent and temporary pile driving operations take place.
- Impact and vibratory driving operations including pile shells, cast-in-steel shells and cast-in-drilled-hole drilled shaft piles.
- Drilling operations employing the use of fluids and/or equipment in the vicinity of waterbodies.

Limitations:

- Comply with all necessary permits required for construction within or near the watercourse, contact the Nevada Division of Environmental Protection to determine which permits apply: <http://ndep.nv.gov/index.htm>

Standards and Specifications:

- When drilling fluid is used, it shall be contained and prevented from flowing into any drainage channels or water bodies. See GM-13 “Liquid Waste Management.”
- Use drip pans or absorbent pads to prevent and clean-up spills during vehicle and equipment maintenance, cleaning, fueling, and storage. Park equipment over plastic sheeting or equivalent where possible.

Drilling & Pile Driving Operations GM-19

- Have spill kits and cleanup materials available at all locations of pile driving and/or drilling. Refer to BMP GM-6 “Spill Prevention and Control.”
- Keep all equipment leak-free, especially when it is stored or in used in or near streambeds and other water bodies.
- The storage or use of equipment in streambeds or other bodies of water shall comply with all applicable permits.
- Implement other BMPs as applicable, such as GM-4 “Dewatering Operations”, and GM-13 “Liquid Waste Management.”
- When not in use, store equipment away from flowing water, drainage courses, and inlets. Prevent storm water from washing contaminants off of hammers and other hydraulic attachments placing them on plywood and covering them when not in use.
- Install Construction Site Entrances and Exits (SC-8) to prevent the tracking of mud and dirt onto public roads by vehicles entering and exiting the construction site.

Inspection and Maintenance:

- Inspect work areas and equipment for leaks and spills on a daily basis.
- Inspect equipment routinely and repair any possible leaks as needed

Material & Equipment Use Over Water

GM-20

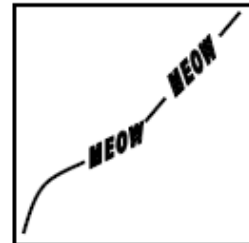
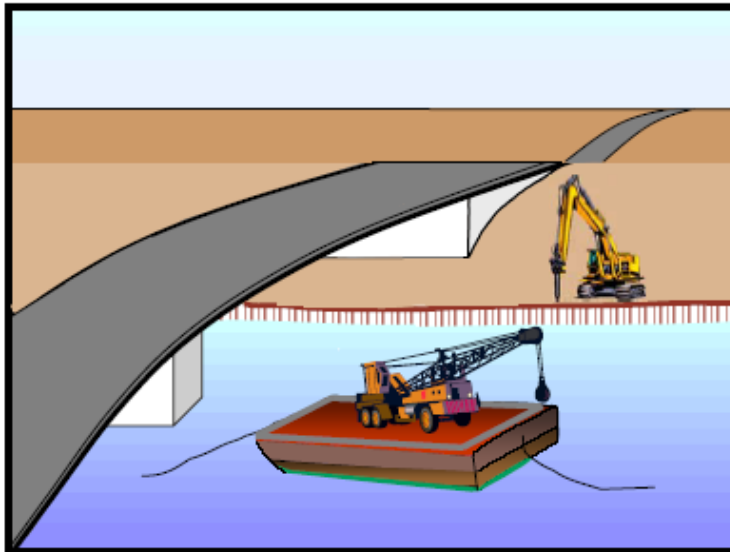

BMP Objectives	
<input type="checkbox"/>	Soil Stabilization
<input type="checkbox"/>	Sediment Control
<input type="checkbox"/>	Tracking Control
<input type="checkbox"/>	Wind Erosion Control
<input checked="" type="checkbox"/>	Non-Storm Water Management
<input checked="" type="checkbox"/>	Materials and Waste Management

Graphics used with permission of NDOT

Purpose: Equipment operation from barges, boats, construction pads, bridges, and platforms directly over a waterbody calls for extra vigilance and care to prevent pollution. This BMP presents procedures for the proper use, storage, and disposal of materials and equipment located above a watercourse.

Applications:

- For construction materials and wastes (solid and liquid) and any other materials that may be detrimental if released.
- Where materials and equipment are used on barges, bridges, boats, docks, and other platforms over or adjacent to a watercourse.

Limitations:

- Comply with all necessary permits required for construction within or near the watercourse, such as Nevada Division of State Lands, U.S. Army Corps of Engineers, NDEP, and other local permitting agencies
- Contact the Regional Water Planning Commission to determine which permits apply: <http://www.co.washoe.nv.us/water/rwpc>.

Standards and Specifications:

- Apply BMPs GM-10 “Material Delivery and Storage” and GM-6 “Spill Prevention and Control”
- Ensure that an adequate supply of spill cleanup materials is available.

Material & Equipment

Use Over Water

GM-20

- If a vehicle or piece of equipment is expected to be idle for more than one hour, drip pans shall be placed under all vehicles and equipment positioned over water bodies.
- Secure all materials in windy conditions, and cover any items that may blow into the water.
- Maintain equipment in accordance with BMP GM-8 “Vehicle and Equipment Maintenance.” Do not conduct maintenance operations over water. If leaks cannot be repaired, do not use equipment over the water.
- Provide watertight curbs or toe boards along the edge of the barge, platform or dock to contain spills and prevent materials, tools, and debris from falling into the water.
- Identify types of spill control measures to be employed, including the storage of such materials and equipment. Ensure that staff is trained regarding the deployment and access of control measures and those measures are being used.
- Remove accumulated wastes in a timely manner and dispose of properly.
- Refer to BMP GM-21 “Structure Demolition/Removal Over or Adjacent to Water.”

Inspection and Maintenance:

- Inspect equipment for leaks and spills on a daily basis, and make necessary repairs.
- Ensure that employees and subcontractors are aware of the BMPs in practice, and implement appropriate measures for storage and use of materials and equipment.
- Inspect and maintain all BMPs frequently to ensure continuous function and protection of the watercourse.

Structure Demolition/Removal Over or Adjacent to Water

GM-21

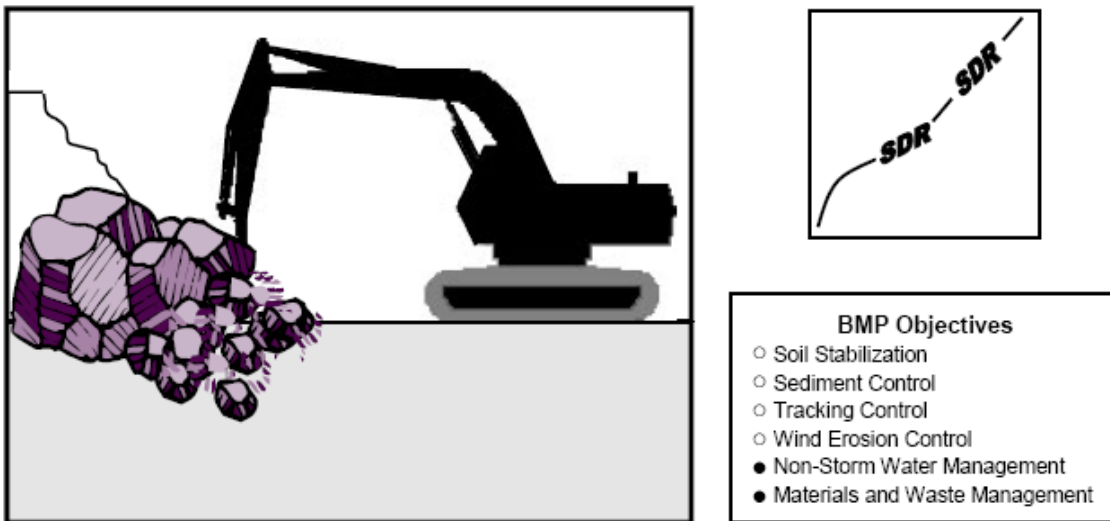

Graphics used with permission of NDOT

Purpose: To protect water bodies from debris and wastes associated with structure demolition or removal over or adjacent to watercourses.

Applications:

- Bridge demolition and removal.
- Bridge modification (barrier rail, edge of deck replacement).
- Bridge widening projects.
- Concrete channel removal.
- Dam removal.

Limitations:

- Comply with all necessary permits required for construction within or near the watercourse, contact the Nevada Division of Environmental Protection to determine which permits apply: <http://ndep.nv.gov/>

Standards and Specifications:

- Do not allow demolished waste material to enter waterway.
- If necessary, divert water away from the demolition area using coffer dams.

Structure Demolition/Removal Over or Adjacent to Water

GM-21

- Backhoes and other equipment may have attachments that can be used to catch debris from small demolition operations.
- Use covers or platforms to surround the site and to collect debris.
- Stockpile accumulated debris and waste generated during demolition in a location away from watercourses and in accordance with BMP GM-2 “Stockpile Management.”
- Do not obstruct safe passage for wildlife.
- Immediately report any accidental discharges to a waterway.
- For structures containing hazardous materials, (i.e., lead paint or asbestos) refer to BMP GM-17 “Hazardous Waste Management”.

Inspection and Maintenance:

- Contractor must inspect demolition areas over or near adjacent watercourses on a daily basis.
- Any debris-catching devices shall be emptied regularly. Collected debris shall be removed and stored away from the watercourse and protected from run-on and runoff.
- Inspect the waterbody regularly to ensure that no adverse impacts are occurring.

Temporary Batch Plants

GM-22



Photograph used with permission of NDOT

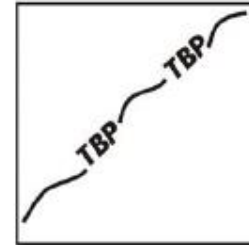

Standard Symbol

BMP Objectives	
<input type="radio"/>	Soil Stabilization
<input type="radio"/>	Sediment Control
<input checked="" type="radio"/>	Tracking Control
<input checked="" type="radio"/>	Wind Erosion Control
<input checked="" type="radio"/>	Non-Storm Water Management
<input checked="" type="radio"/>	Materials and Waste Management

Purpose: Many construction projects requires temporary batch plant facilities to crush rock, manufacture asphalt concrete (AC) or Portland cement concrete (PCC) near the construction site. These facilities typically use materials such as fly ash, lime, cement, sand and gravel, concrete additives and water. Proper control and use of equipment, materials, and waste products from temporary batch plant facilities will reduce the discharge of potential pollutants to the storm drain system or watercourses, reduce air emissions, and mitigate noise impacts. The BMPs presented in this fact sheet offer guidelines for complying with NDEPs 2015 General Permit requirements.

Applications:

- On-site and off-site temporary batch plant facilities for construction sites.

Limitations:

- Specific permit requirements by Washoe County, NDEP and local noise ordinances, may be applicable because of air emissions, storm and non-storm water discharges, and/or noise.
- If the temporary batch plant serves multiple projects, then separate NPDES permit coverage must be obtained under the Nevada General Construction Permit (e.g. permit coverage under one associated construction project is not sufficient).

Temporary Batch Plants

GM-22

Standards and Specifications:

Planning

- Implement proper planning, design, and construction of temporary batch plants to minimize potential water quality, air pollution, and noise impacts.
- Consider wind direction and areas sensitive to air pollution when planning batch plant locations.
- Plan placement of access roads to minimize water and air quality impacts.

Layout and Design

- Locate and design temporary batch plants to minimize potential water quality impacts to receiving water bodies. Locate batch plants away from watercourses, drainage courses, and drain inlets. Locate batch plants to minimize the potential for storm water run-on to the site.
- Locate temporary batch plant facilities (including associated stationary equipment and stockpiles) at least 300 feet from any recreational area, school, residence, or other structure not associated with the construction project.
- Continuous interior AC or PCC berms around batch plant equipment (mixing equipment, silos, concrete drop points, conveyor belts, admixture tanks, etc.) can facilitate proper containment and cleanup of releases. Place rolled curb or dikes at ingress and egress points, and loading areas.
- Direct storm water and non-storm water runoff from paved or unpaved portions of the batch plant facility to catchment ponds, tanks, or a lined washout area or baker tank.
- Construct and remove concrete washout facilities in accordance with BMP fact sheet GM-9 “Handling and Disposal of Concrete and Cement”.

Operational Procedures

- Conduct washout of concrete trucks in a designated area in accordance with BMP fact sheet GM-9 “Handling and Disposal of Concrete and Cement”.
- Do not dispose of concrete slurry into drain inlets, the storm water drainage system or watercourses.
- Washing equipment, tools, or vehicles to remove PCC shall be conducted in accordance with BMP fact sheets GM-9 “Vehicle and Equipment Cleaning” and GM-7 “Handling and Disposal of Concrete and Cement”

Temporary Batch Plants

GM-22

- All dry material transfer points shall be ducted through cartridge type filter unless there are no visible emissions from the transfer point.
- Equip all bulk storage silos, including auxiliary bulk storage trailers, with fabric or cartridge type filter(s).
- Maintain silo vent filters in proper operating condition.
- Equip silos and auxiliary bulk storage trailers with a visible and/or audible warning mechanism to warn operators that the silo or trailer is full.
- Equip silos and auxiliary bulk storage trailers with dust-tight service hatches.
- Fabric dust collection system shall be capable of controlling particulate matter in compliance with the project's Air Quality Permit.
- Equip fabric dust collectors (except for vent filters) with an operational pressure differential gauge to measure the pressure drop across the filters.
- Equip all transfer points with a wet suppression system to control fugitive particulate emissions unless there are no visible emissions.
- Cover or equip all conveyors with spray systems, unless the material being transferred results in no visible emissions.
- Collect dust emissions from the loading of open-bodied trucks at the drip point of dry batch plants, or dust emissions from the drum feed for central mix plants.
- Spray with water and cover with a tarp all open-bodied vehicles transporting unmixed, unconsolidated, or dry material to reduce emissions.

Tracking Control

- Stabilize plant roads (batch truck and material delivery truck roads) and areas between stockpiles and conveyors, by watering, treated with dust-palliatives, or paving with a cohesive hard surface that can be repeatedly swept, washed, and maintained intact and cleaned as necessary to control dust emissions. Refer to BMP fact sheet SC-10 "Stabilized Construction Roadway" for additional information.
- Do not allow trucks to track PCC from plants onto public roads. Use appropriate practices from BMP fact sheet SC-8 "Construction Entrances and Exits" to prevent tracking.

Materials Storage

- Refer to BMP fact sheet GM-11 “Material Delivery Handling, Storage and Use” for all batch plants using concrete components or compounds. An effective strategy is to cover and contain.

Temporary Batch Plants

GM-22

- Use materials in a way to minimize or eliminate the discharge of materials to storm drain system or watercourse.
- Minimize dispersion of finer materials into the air during operations, such as unloading cement delivery trucks.
- When not actively being used, cover stockpiles and enclose with perimeter sediment barriers per BMP fact sheet GM-2 “Stockpile Management”. Sprinkle uncovered stockpiles with water and/or dust-palliatives as necessary to control dust emissions. Provide an operable stockpile water system onsite at all times.
- Store bagged and boxed materials on pallets and cover top and sides of materials on nonworking days or prior to rain.
- Provide secondary containment for liquid materials (GM-13) per CFR (Code of Federal Regulations) Sections 110, 117, and 302. The volume of the secondary containment area shall be at least 1.5 times the volume of the primary container.
- Immediately clean up spilled cement and fly ash and contain or dampen so that dust or emissions from wind erosion or vehicle traffic are minimized.

Equipment Maintenance

- Maintain equipment to prevent fluid leaks and spills per BMP fact sheet GM-7 “Vehicle and Equipment Maintenance and Fueling”.
- Maintain adequate supplies of spill cleanup materials and train staff to respond to spills per BMP fact sheet GM-6 “Spill Prevention and Control”.

Inspection and Maintenance:

- Inspect batch plant components daily during batch plant construction and operation.
- Inspect and repair equipment (for damaged hoses, fittings, and gaskets).
- Inspect and maintain Stabilized Construction Entrance/Exit BMPs as needed.

Temporary Batch Plants

GM-22

Typical Temporary Batch Plant Layout

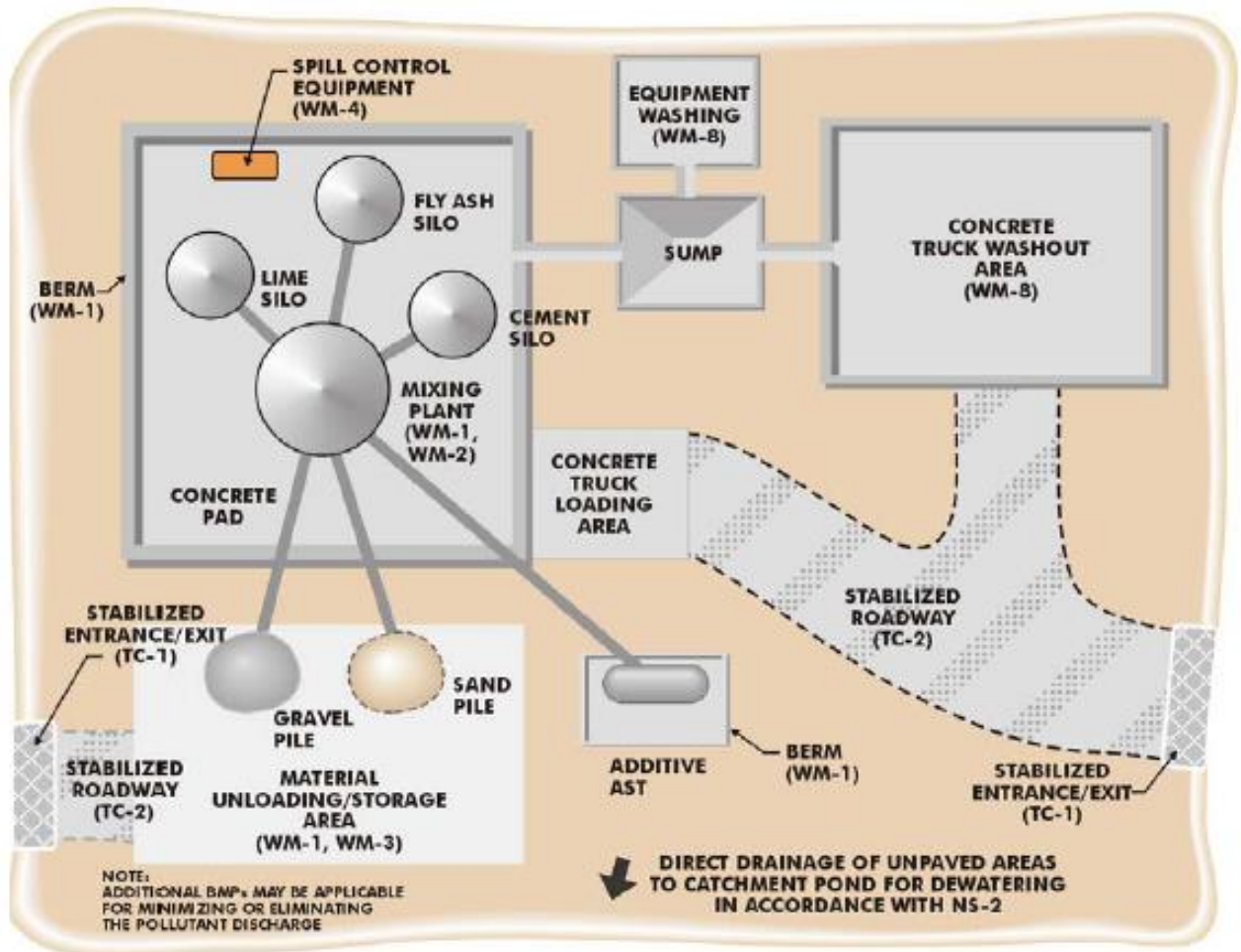

Graphics used with permission of NDOT

Appendix A
General Construction Permit NVR100000

NVR100000

STATE OF NEVADA
DIVISION OF ENVIRONMENTAL PROTECTION

PERMIT FOR
STORMWATER DISCHARGES ASSOCIATED WITH LARGE CONSTRUCTION ACTIVITY, SMALL
CONSTRUCTION ACTIVITY AND INDUSTRIAL ACTIVITY FROM TEMPORARY CONCRETE, ASPHALT AND
MATERIAL PLANTS OR OPERATIONS DEDICATED TO THE PERMITTED CONSTRUCTION PROJECT

AUTHORIZATION TO DISCHARGE

In compliance with the provisions of the federal Water Pollution Control Act as amended (33 U.S.C. 1251 et seq: the "Act") and Chapter 445A of the Nevada Revised Statutes (NRS), eligible dischargers have submitted: 1) a Notice of Intent and filing fee in accordance with Nevada Administrative Code (NAC) 445A.268.

In accordance with the terms and conditions set forth hereof;

Site Number: CSW- XXXXX

NOI Approval Date: mm/dd/yyyy

Facility Information	
Site Name	XX
Site Address	XX
Owner Name	XX
Operator Name	XX

This permit shall become effective on: **January 5, 2015**

This permit and the authorization to discharge shall expire at midnight **January 4, 2020.**

Signed this **18th** day of **December 2014.**

Michele R. Reid
Staff Engineer I
Bureau of Water Pollution Control



Table of Contents

1.0 Coverage Under this Permit	1
1.1 Eligibility	1
1.2 Authorized Discharges	1
1.3 Prohibited Discharges	3
1.4 Limitations of Coverage	3
1.5 Requirement for Individual Permit.....	4
1.6 Requirement for a Stormwater Permit for Projects less than 1 acre	4
2.0 Authorization Under this General Permit	4
2.1 Owner/Operator Responsibility	4
2.2 Application for Coverage.....	5
2.3 NOI Electronic Application Requirements	6
2.4 Effective Date of Permit Coverage	7
2.5 Emergency-Related Construction Activities	7
2.6 Continuation of This Permit.....	8
2.7 Requirement to Post a Notice of Permit Coverage	8
2.8 Terminating Coverage	8
3.0 Effluent Limitations Applicable to All Discharges	9
3.1 Provisions for Existing Construction Projects	9
3.2 Non-Numeric Effluent Limitations and Associated Control Measures	10
3.3 General Maintenance Requirements	10
3.4 Erosion and Sediment Controls	11
3.5 Erosion and Sediment Controls Required by All Sites	12
3.6 Site Stabilization Requirements, Schedules, and Deadlines	16
3.7 Pollution Prevention Requirements.....	17
3.8 Dewatering Practices	19
3.9 Water Quality Standards.....	20
4.0 Limitations Applicable to Sites w/Constructed Stormwater Channels and Basins	21
4.1 Constructed Stormwater Conveyance Channels	21
4.2 Sediment Basins	21
5.0 Inspections	22
5.1 Inspector Qualifications.....	22
5.2 Routine Site Inspection Procedures.....	22
5.3 Reduced Inspection Schedule	23
5.4 Routine Facility Inspection Documentation.....	24
5.5 Inspection Results.....	24
5.6 Inspection Follow-up	24

6.0 Stormwater Pollution Prevention Plan (SWPPP)	24
6.1 General SWPPP Information	24
6.2 SWPPP Contents	25
6.3 Documentation Requirements Including Permit Related Records	29
6.4 SWPPP Updates and Modification Requirements	29
6.5 Deficiencies in the SWPPP	30
6.6 Procedures for Inspection, Maintenance, and Corrective Action	31
6.7 SWPPP Review and Making SWPPPs Available	31
7.0 General Permit Conditions	31
7.1 Annual Fee.....	31
7.2 General Permit Re-issuance for Ongoing Projects	31
7.3 Facilities Operations	32
7.4 Need to Halt or Reduce Activity Not a Defense	32
7.5 Noncompliance, Unauthorized Discharge, Bypass, and Upset	32
7.6 Sampling and Analysis.....	33
7.7 Test Procedures.....	33
7.8 Recording Results.....	33
7.9 Odors	34
7.10 Removed Substances.....	34
7.11 Changes in Discharge.....	34
7.12 Adverse Impact	34
7.13 Right of Entry	34
7.14 Transfer of Ownership or Control.....	34
7.15 Availability of Reports	35
7.16 Furnishing False Information and Tampering with Monitoring Devices	35
7.17 Penalty for Violation of General Permit Conditions	35
7.18 General Permit Modification, Suspension or Revocation	35
7.19 Liability	36
7.20 Property Rights	36
7.21 Records Retention	36
7.22 Severability	36
7.23 Signature Requirements	36
7.24 Changes to Authorization.....	37
7.25 Certification Requirements.....	37
7.21 Address for Fee Payment, NOI Certification Page and Notice of Termination Form	37
Appendixes	
Appendix A – Definitions, Abbreviations and Acronyms	39-44
Appendix B – DeMinimis Discharge Sampling and Limitations.....	46-47

1.0 Coverage under this General Permit

1.1 Eligibility

- 1.1.1 The objective of this permit is to control and reduce pollution to Waters of the State of Nevada that meet the definition of Waters of the United States from: Stormwater Discharges Associated with Construction Activity and Stormwater Discharges Associated with Industrial Activity from temporary plants or operations set up to produce concrete, asphalt or other materials exclusively for the permitted construction project, through the use of Best Management Practices (BMPs).
- 1.1.2 This General Permit authorizes stormwater discharges associated with large construction activity, small construction activity and associated industrial activity, provided the operator complies with all the requirements of this general permit and submits a Notice of Intent (NOI) in accordance with Part 2.3 of this general permit. A waiver from coverage under this permit is not offered.
- 1.1.3 This permit is not authorized for use by operators with stormwater discharges associated with construction activities on any Tribal Lands in Nevada. USEPA Region 9 is the permitting authority for Tribal Lands in Nevada.
- 1.1.4 Any discharges that do not comply with the eligibility conditions of this permit are not authorized by the permit. A person shall either apply for a separate National Pollutant Discharge Elimination System (NPDES) permit to cover the ineligible discharge(s), cease the discharge(s), or take necessary steps to make the discharge(s) eligible for coverage under this permit.

1.2 Authorized Discharges

- 1.2.1 Allowable Stormwater Discharges. Subject to compliance with the terms and conditions of this permit, the following is a list of discharges that are allowed under the permit provided that appropriate stormwater controls are designed, installed and maintained:
- 1.2.1.1 Stormwater runoff associated with construction activities;
- 1.2.1.2 Stormwater discharges from construction support activities (e.g. concrete or asphalt batch plants, equipment staging yards, material storage yards, excavated material disposal areas, borrow areas) provided:
- 1.2.1.2.1 The support activity is directly related to a construction site that is required to have NPDES permit coverage for discharges of stormwater associated with construction activity;
- 1.2.1.2.2 The support activity is not a commercial operation (serving multiple unrelated construction projects by different operators) and does not operate beyond the completion of the construction activity at the last construction project it supports; and
- 1.2.1.2.3 Appropriate controls and measures covering the discharges from the support activity areas are identified in a stormwater pollution prevention plan (SWPPP).

1.2.2 Allowable Non-Stormwater Discharges. The operator shall reduce or eliminate discharges of non-stormwater from construction sites to the maximum extent practicable.

1.2.2.1 The following are non-stormwater discharges allowed under this permit, provided they are not a significant source of pollutants and appropriate control measures are in place to assure compliance with Parts 3.0 and 3.8 of this permit:

1.2.2.1.1 Discharges from emergency fire-fighting activities;

1.2.2.1.2 Water used to rinse/wash vehicles and equipment, provided that reclaimed water or other wastewater is not used and no soaps, solvents, detergents, oils, grease, or fuels are present in the rinse/wash water;

1.2.2.1.3 Water used to control dust, provided reclaimed water or other wastewaters are not used;

1.2.2.1.4 Routine external building wash-down where detergents are not used;

1.2.2.1.5 Pavement wash waters where spills or leaks of toxic or hazardous materials have not occurred (unless all spilled material has been removed) and where detergents are not used. Directing pavement wash waters directly into any surface water, storm drain inlet, or stormwater conveyance without the appropriate pollution control measures in place is prohibited;

1.2.2.1.6 Uncontaminated air conditioning or compressor condensate;

1.2.2.1.7 Dewatering of accumulated stormwater where flows are not contaminated (see Part 3.8 Dewatering Practices); and

1.2.2.1.8 Water used for compacting soil, provided reclaimed water or other wastewaters are not used.

1.2.3 Allowable Non-Stormwater DeMinimus Discharges

1.2.3.1 The following are non-stormwater de minimis discharges allowed under this permit, provided they are not a significant source of pollutants and appropriate control measures are in place to assure compliance with Parts 3.0 and 3.8 of this permit:

1.2.3.1.1 Uncontaminated, non-turbid groundwater or spring water;

1.2.3.1.2 Foundation or footing drains where flows are not contaminated with process materials such as solvents or contaminated groundwater;

1.2.3.1.3 Potable water sources including uncontaminated water line flushing; and

1.2.3.1.4 Uncontaminated, non-turbid potable water well flushing where the receiving waters are ephemeral.

1.2.3.2 DeMinimis Discharges are limited to one discharge outfall per permitted site. The discharge flow is limited to 250 gallons per minute (gpm) or less for 30 days or less. DeMinimis discharges that exceed these conditions must apply for permit coverage under the General Permit for DeMinimis Discharges NVG201000 at <http://ndep.nv.gov/bwpc/diminimis.htm>

1.3 Prohibited Discharges

- 1.3.1 The operator shall not allow any non-stormwater discharges from the site except as provided in Part 1.2.2, 1.2.3 or Part 3.8 Dewatering Practices. All other non-stormwater discharges shall be eliminated or authorized under a separate permit as determined by NDEP. The prohibited discharges include but are not limited to:
- 1.3.1.1 Wastewater from washout of concrete, unless managed by an appropriate control described in Part 3.7.2.2;
 - 1.3.1.2 Wastewater from washout and cleanout of stucco, paint, form release oils, curing compounds and other construction materials. See Part 3.7.2.3;
 - 1.3.1.3 Fuels, oils, or other pollutants used in vehicle and equipment operation and maintenance. See Part 3.7.2.4;
 - 1.3.1.4 Soaps or solvents used in vehicle and equipment washing; and
 - 1.3.1.5 Toxic or hazardous substance from a spill or other release.
- 1.3.2 Stormwater discharges that are mixed with non-stormwater, other than the allowable non-stormwater discharges listed in Part 1.2.2, are not eligible for coverage under this permit.

1.4 Limitations of Coverage

- 1.4.1 Post Construction Discharges. This general permit does not authorize stormwater discharges that originate from the site after construction activities have been completed and the site, including any temporary support activity site, has achieved final stabilization and a Notice of Termination (NOT) has been filed. Post construction stormwater discharges from industrial sites may need to be covered by a separate NPDES permit.
- 1.4.2 Discharges Covered by Another NPDES Permit. This general permit does not authorize discharges associated with construction activities that have been covered under an individual permit or another applicable general permit. Construction discharges at mining operations are covered under the Mining General Permit NVR300000.
- 1.4.3 Discharges Threatening Water Quality. This general permit does not authorize discharges that will cause or contribute to non-attainment of water quality standards or the beneficial uses of receiving waters as defined in NAC 445A.121 and NAC 445A.122 respectively. The operator shall design and implement BMPs sufficient to meet these requirements.
- 1.4.4 Discharges to Water Quality Impaired Waters. A discharge to a surface water contained in the current 303(d) *Impaired Water Body* listing issued by NDEP Bureau of Water Quality Planning (BWQP), that is impaired for (1) sediment or a sediment-related parameter, such as total suspended solids (TSS) or turbidity, and/or (2) nutrients, including impairments for nitrogen and/or phosphorus shall make one of the following demonstrations and retain such data and technical information on site with the Stormwater Pollution Prevention Plan (SWPPP):
- 1.4.4.1 That the site will employ measures to prevent the discharge of stormwater pollutant(s) for which the waterbody is impaired; or

- 1.4.4.2 That the discharge from the site has no potential to contain the pollutants causing impairment; or
- 1.4.4.3 That the discharge is not expected to cause or contribute to an exceedence of an applicable water quality standard.
- 1.4.5 Discharges to Water Bodies with Established Total Maximum Daily Load (TMDL). The Permittee shall comply with all applicable TMDL requirements. TMDL information can be found on the NDEP website: <http://ndep.nv.gov/bwqp/303dlist2012.htm>
- 1.4.6 Exempt Discharges. Persons performing the following activities are not required to seek coverage under this permit:
 - 1.4.6.1 Construction projects that disturb less than 1 acre, unless part of a larger common plan of development or sale (e.g., subdivisions or commercial development areas) or unless required as a condition of Part 1.6.1;
 - 1.4.6.2 Routine maintenance that disturbs less than 5 acres that is performed to maintain the original line and grade, hydraulic capacity, or original purpose of a facility or structure; or
- 1.4.7 Use of Cationic Treatment Chemicals. The use of cationic treatment chemicals (as defined in Appendix A), are ineligible for coverage under this permit, unless the Permittee notifies NDEP in advance and the Administrator authorizes the coverage under this permit. The Permittee must include appropriate controls and implementation procedures designed to ensure that any approved use of cationic treatment chemicals will not lead to a violation of water quality standards.
- 1.4.8 Oil and Gas Operations. Construction activities associated with the oil and gas exploration, production, processing, or treatment operations or transmission facilities (e.g. drilling site preparation, crude oil pipelines, etc.) are addressed in NDEP's Stormwater General Permit NVR050000 for Stormwater Associated with Industrial Activity.

1.5 Requirement for Individual Permit

- 1.5.1 NDEP may require the holder of a general stormwater permit to apply for and obtain an individual permit in accordance with NAC 445A.269.

1.6 Requirement for a Stormwater Permit for Projects Less Than 1 Acre

- 1.6.1 If NDEP determines that a project less than 1 acre in size will impact receiving waters or their tributaries within a 1/4-mile radius of the project, the owner of the project may be required to obtain a stormwater permit and abide by the terms of this permit.

2.0 Authorization Under this General Permit

2.1 Owner/Operator Responsibility

- 2.1.1 All Operators. All operators are required to obtain coverage for stormwater discharges associated with construction activity under this permit. In some cases, an operator may be

the owner or the developer, in other cases the operator may be the general contractor. In the event of a default by the “Operator” submitted on the NOI, NDEP will consider the “Owner” submitted on the NOI as the responsible “Operator”. For the purpose of this permit, an “Operator” is any person associated with the construction project who meets the following criteria:

- 2.1.1.1 The person has operational control over the construction plans and specifications, including the ability to make modifications to those plans and specifications; or
- 2.1.1.2 The person has day-to-day operational control of those activities at a project that are necessary to ensure compliance with the permit conditions (e.g., they are authorized to direct workers at a site to carry out activities required by the permit).
- 2.1.2 Multiple Operators. Where there are multiple operators associated with the same project, each operator is required to file an NOI for permit coverage. The following applies in these situations:
 - 2.1.2.1 If one operator has control over plans and specifications and a different operator has control over activities at the project site, they may divide responsibility for compliance with the terms of this permit and jointly develop a common SWPPP, which documents which operator has responsibility for each requirement of the permit.
 - 2.1.2.2 If an operator only has operational control over a portion of a larger project (e.g. one of the four homebuilders in a subdivision), the operator is responsible for compliance with applicable effluent limits, terms and conditions of this permit as it relates to their activities on their portion of the construction site, and implementation of control measures described in the SWPPP in the areas under their control.
 - 2.1.2.3 Operators shall ensure, either directly or through coordination with other operators, that their activities do not render another operator’s pollutant discharge controls ineffective.

2.2 Application for Coverage

- 2.2.1 Prior to submission of a Notice of Intent (NOI), an applicant seeking authorization to discharge under this general permit shall:
 - 2.2.1.1 Ensure that the facility is not located on Tribal lands;
 - 2.2.1.2 Ensure the facility meets the eligibility requirements under Part 1.1; and
 - 2.2.1.3 Develop and implement a SWPPP that meets the requirements of Part 6.0 of this permit and that covers either the entire site or all portions of the site for which the Permittee is an operator.
 - 2.2.1.3.1 The SWPPP shall be prepared prior to submission of the NOI and shall be implemented prior to the start of construction.
 - 2.2.1.3.2 It is not necessary to submit a copy of the SWPPP to NDEP. The SWPPP, including any updates, shall be retained and made available in accordance with Part 6.7.1.

- 2.2.1.4 An operator shall submit separate NOIs to NDEP for each project that disturbs one or more acres of land. The operator of a common plan of development or sale that will ultimately disturb one or more acres shall also submit an NOI in accordance with Part 2.3.

2.3 NOI Electronic Application Requirements

- 2.3.1 NOIs must be submitted using NDEP's electronic NOI system. Submission of the NOI demonstrates the owner's/operator's intent to be covered by this permit; it is not a determination by NDEP that the owner/operator has met the eligibility requirements for the permit.
- 2.3.2 New Dischargers seeking authorization for stormwater discharges under this general permit shall submit a Notice of Intent (NOI) and filing fee with NDEP no later than 14 days prior to the start of the permitted activity. The NOI application may be accessed via the NDEP website at: <https://genpermits.ndep.nv.gov/>
- 2.3.3 Existing Dischargers seeking authorization for stormwater discharges under this general permit shall submit a **RENEWAL** Notice of Intent (NOI) within 60 days (**by March 6, 2015**) of the effective date of this permit. **NO FEE IS REQUIRED FOR A RENEWAL NOI.** The Renewal NOI application may be accessed via the NDEP website at: <https://genpermits.ndep.nv.gov/>
- 2.3.4 The minimum information required for an approved NOI consists of:
- 2.3.4.1 Project Owner and Operator (Applicant) Information – Name, Address, City, State, Zip Code, Phone Number(s) and Tax Identification Number for both the owner and operator;
- 2.3.4.2 Project/Site Information – Project Name, Project Address/Location, City, County, State, Zip Code, Latitude, Longitude, and at least one Assessor's Parcel Number (APN) associated with the project;
- 2.3.4.3 Name of the receiving water;
- 2.3.4.4 Whether any part of the site is located on Tribal lands;
- 2.3.4.5 Estimated start date;
- 2.3.4.6 Estimated completion date;
- 2.3.4.7 Estimate of area to be disturbed (to nearest acre);
- 2.3.4.8 Estimate for likelihood of discharge;
- 2.3.4.9 Address for location of SWPPP for viewing – City, State, Zip Code and Phone Number(s); and
- 2.3.4.10 NOI Certification page signed and dated by appropriate authority (see Part 7.23) and mailed with the application fee to NDEP at the address indicated on the form and in Part 7.26 of this permit.
- 2.3.5 If the contact information or addresses on the NOI filed for permit coverage change during

the permit coverage, the Permittee shall, within 15 days of the change, submit a letter on official letterhead indicating the updated information.

2.4 Effective Date of Permit Coverage

2.4.1 New Discharger – Following receipt of the NOI Certification Page and applicable Application Fee, NDEP will determine if the NOI is complete and confirm coverage by providing an Approval Letter with a site authorization number.

2.4.2 If NDEP determines the NOI is incomplete, coverage may not be “approved” until a completed NOI is submitted. NDEP will notify an applicant of an incomplete application within 7 days of receipt of the NOI Certification Page in the Bureau of Water Pollution Control.

2.4.2.1 In accordance with NAC 445A.268 (4), a discharger will not be covered under a general permit until the discharger has been notified by the Director.

2.4.3 Existing Discharger – For operators of construction projects ongoing as of the effective date of this permit who received authorization to discharge for these projects under the expired 2007 Construction General Permit (NVR100000), the Operator shall submit a Renewal NOI within 60 days of the effective date of this permit (**by March 6, 2015**). NDEP will determine if the NOI is complete and confirm coverage by providing a Renewal Approval Letter. Following receipt of the renewal approval letter the operator shall comply with the following terms:

2.4.3.1 Within 120 days of the effective date of this permit (**by May 5, 2015**), the Permittee shall update the SWPPP as necessary to comply with the requirements of Part 6.0 of this permit.

2.4.3.2 The Permittee shall continue to comply with the terms and conditions of the expired 2007 Construction General Permit NVR100000 until the SWPPP is updated.

2.4.4 Change of Owner/Operator – For construction projects where the owner/operator changes, including instances where an operator is added after an NOI has been submitted, the following shall apply:

2.4.4.1 **Current operator** shall notify the succeeding owner/operator of the existence of this permit by letter, a copy of which shall be forwarded to NDEP for file record;

2.4.4.2 **New operator** shall update SWPPP documents as needed or develop and implement a new SWPPP to comply with permit requirements in Part 6.0; and submit an NOI **within 14 calendar days** of taking over operational control of the site; and

2.4.4.3 **Current operator** shall submit a Notice of Termination (NOT) **within 30 calendar days** after the new owner/operator assumes responsibility for the site.

2.5 Authorization of Emergency-Related Construction Activities

2.5.1 Emergency-related construction activities are automatically authorized provided that;

2.5.1.1 An operator is conducting earth-disturbing activities in response to a public

emergency (e.g., natural disaster, widespread disruption in essential public services), and the related work requires immediate authorization to avoid imminent endangerment to human health, public safety, or the environment, or to reestablish essential public services;

- 2.5.1.2 If the activity continues past 30 calendar days of commencing construction activities, the operator shall prepare a SWPPP and submit an NOI in accordance with Parts 2.2 and 2.3 of this permit;
 - 2.5.1.3 The operator provides documentation in the SWPPP to substantiate the occurrence of the public emergency; and
 - 2.5.1.4 The operator complies with all other applicable requirements in the permit regarding discharges associated with the construction activities.
- 2.5.2 Operators of emergency-related construction activities are considered provisionally covered under the terms and conditions of this permit immediately, and fully covered within 14 calendar days after NDEP receives a complete NOI and application fee in accordance with Part 2.3 above.

2.6 Continuation of this Permit

- 2.6.1 If this permit is not reissued or replaced prior to the expiration date, it will be administratively continued and remain in force and effect. If the operator is authorized to discharge under this permit prior to the expiration date, any discharges authorized under this permit will automatically remain covered by this permit until:
- 2.6.1.1 The owner/operator submits an NOI requesting authorization to discharge under a renewal or revision of the permit and NDEP issues an Approval Letter; or
 - 2.6.1.2 The owner/operator submits a NOT; or
 - 2.6.1.3 A formal permit decision is made by NDEP not to reissue this general permit, at which time NDEP will identify a reasonable time period for covered dischargers to seek coverage under an alternative general permit or an individual permit. Coverage under this permit will cease at the end of this time period.

2.7 Requirement to Post a Notice of Permit Coverage

- 2.7.1 The Permittee shall post a sign or other notice conspicuously at a safe, publicly accessible location in close proximity to the project site. At a minimum, the notice shall include the Permit site ID (CSW-xxxxx) and a contact name and telephone number.
- 2.7.2 The notice shall be located so that it is visible from the public road that is nearest to the active part of the construction site, and it shall use a font large enough to be readily viewed from a public right-of-way. For linear projects, the site authorization number(s) shall be posted near the entrance where most of the construction activity is occurring.

2.8 Terminating Coverage

- 2.8.1 To terminate coverage, the Permittee shall submit a completed hard-copy Notice of

Termination (NOT) form, available at <http://ndep.nv.gov/bwpc/forms.htm>, to the address listed on the form and in Part 7.26 of this permit. The submitted form shall include a wet signature; copies will not be accepted. The facility's authorization to discharge will expire at midnight of the day that a complete NOT form is received by NDEP. The permittee is responsible for meeting the terms and conditions of this permit until the facility's authorization to discharge are terminated.

- 2.8.1.1 Should an electronic NOT version become available during the term of this permit a link for this electronic reporting requirement will be provided on the NDEP Stormwater page at http://ndep.nv.gov/bwpc/storm_cont03.htm
- 2.8.2 All Notice of Termination (NOT) forms shall be signed in accordance with the signatory requirements of Part 7.23.
- 2.8.3 The Permittee may submit an NOT form to NDEP after any of the following conditions have been met:
 - 2.8.3.1 The Permittee has established final stabilization on all portions of the site for which the operator is responsible, in accordance with Part 3.6.3; or
 - 2.8.3.2 Another operator, who has a valid NOI and site number under this general permit or an individual NPDES permit, has assumed control over all areas of the site that have not been finally stabilized; or
 - 2.8.3.3 For residential construction only, temporary stabilization has been completed and the residence has been transferred to the homeowner in accordance with Part 3.6.3.2 of this permit; or
 - 2.8.3.4 The planned construction activity identified on the original NOI was never initiated (i.e., no grading or earthwork was ever started and plans for construction have been permanently abandoned or indefinitely postponed); or
 - 2.8.3.5 The operator has obtained coverage for the site under another NPDES permit.
- 2.8.4 The minimum information required on a NOT consists of:
 - 2.8.4.1 Site specific identification number (i.e., CSW-xxxxx);
 - 2.8.4.2 Owner/Operator (Applicant) Information – name, address, city, state, Zip Code and phone number(s);
 - 2.8.4.3 Project/Site Information – project name, project address/location, city, county, state, Zip Code, latitude, longitude or APN, and phone number(s); and
 - 2.8.4.4 Certification signed and dated by the appropriate authority (see Parts 8.23 and 8.25).

3.0 Effluent Limitations Applicable to All Discharges from Construction Sites

3.1 Provisions for Existing Construction Projects

- 3.1.1 If a project is an “existing project” as defined in Appendix A, or if a person is a new operator of an existing project, and it is infeasible for the operator to comply with a specific requirement in Part 3.0 because (1) the requirement was not part of the permit the project was previously covered under (i.e. the 2007 CGP NVR100000) and (2) the operator is prevented from compliance due to the nature or location of earth disturbances at the site, or the operator is unable to comply with the requirement due to the manner in which the stormwater controls have already been installed or were already designed prior to **January 5, 2015**, the project is waived from complying with that requirement as long as the operator documents this fact in the SWPPP. This provision only applies to those portions of a project that have already commenced earth-disturbing activities or where stormwater controls implemented in compliance with the previous permit have already been installed.

3.2 Non-numeric Effluent Limitations and Associated Control Measures

- 3.2.1 The stormwater control requirements in this Part are technology-based, effluent limitations that, where applicable, apply to all discharges from construction sites eligible for coverage under this permit. These requirements apply the national effluent limitations guidelines and new source performance standards found at 40 CFR Part 450. The Permittee shall comply with the stormwater control requirements included in Part 3.0 through site planning and through designing, installing, and maintaining stormwater controls.
- 3.2.2 Whenever applicable, the operator shall design, install and maintain the following control measures at construction sites:
- 3.2.2.1 Erosion and sediment control (Part 3.4 and Part 3.5);
 - 3.2.2.2 Site Stabilization (Part 3.6); and
 - 3.2.2.3 Pollution Prevention (Part 3.7);

3.3 General Maintenance Requirements

- 3.3.1 The operator shall ensure that all control measures required in this Part remain in effective operating condition during permit coverage and are protected from activities that would reduce their effectiveness.
- 3.3.2 The operator shall inspect all control measures in accordance with the inspection requirements in Part 5.0. The operator shall document the findings in accordance with Part 5.4. When controls need to be replaced, repaired or maintained, the operator shall make the necessary repairs or modifications in compliance with the following schedule:
- 3.3.2.1 Initiate work to correct the problem immediately after discovery, and complete such work by the close of the next work day, if feasible and the problem does not require significant maintenance, repair or replacement.
 - 3.3.2.2 If existing control measures need significant repair or modification, or if additional control measures are necessary, implementation shall be completed within 7 calendar days or before the next storm event (whichever is sooner). If implementation before the next storm event is impracticable, the reason(s) for the delay shall be documented in the SWPPP and alternative control measures shall be implemented as soon as possible. Additionally, the following maintenance activities

shall be implemented:

- 3.3.2.2.1 Remove accumulated sediment when it reaches a maximum of one-half the height of the silt fence or one-half the height of the fiber roll.
- 3.3.2.2.2 Sediment shall be removed from temporary and permanent sedimentation basins, ponds and traps when the depth of the sediment collected in the basin reaches 50% of the storage capacity.
- 3.2.2.2.3 Construction site egress location(s) shall be inspected for evidence of off-site tracking of sediment, debris, and other pollutants onto paved surfaces. Removal of sediment, debris, and other pollutants from all off-site paved areas shall be completed as soon as practicable, or as otherwise required by Federal, State, and local requirements.
- 3.2.2.2.4 Accumulations of sediment, debris, and other pollutants observed in off-site surface waters, drainage ways, catch basins, and other drainage features shall be removed in a manner and at a frequency sufficient to minimize impacts and to ensure no adverse effects on water quality.

3.4 Erosion and Sediment Controls

- 3.4.1 The Operator shall design, install, and maintain erosion and sediment controls that minimize the discharge of pollutants from earth-disturbing activities. The operator shall minimize the amount of soil exposed during construction activities and control stormwater volume and velocity to minimize soil erosion. The operator is also subject to the deadlines for temporarily and/or permanently stabilizing exposed portions of the site in accordance with Part 3.6.
- 3.4.2 Design Requirements – The operator shall account for the following factors in designing stormwater controls:
 - 3.4.2.1 The expected amount, frequency, intensity, and duration of a 2-year, 24-hour precipitation event;
 - 3.4.2.2 The nature of stormwater runoff and run-on at the site, including factors such as expected flow from impervious surfaces, slopes, and site drainage features. If any stormwater flow will be channelized at the site, stormwater control measures shall be designed to control both peak flow rates and total stormwater volume to minimize channel and stream bank erosion and scour in the immediate vicinity of discharge points:
 - 3.4.2.3 The range of soil particle sizes expected to be present on the site.
- 3.4.3 The operator shall direct discharges from stormwater controls to vegetated areas of the site to increase sediment removal and maximize stormwater infiltration, including any natural buffers established under Part 3.5.1, unless infeasible. Use velocity dissipation devices if necessary to prevent erosion when directing stormwater to vegetated areas.
- 3.4.4 Installation Requirements
 - 3.4.4.1 Complete installation of stormwater controls by the time each phase of the earth disturbance has begun. By the time construction activities in any given portion of the

site have begun, unless infeasible, the operator shall install and make operational any down-gradient sediment controls (e.g., buffers, or equivalent sediment controls, perimeter controls, exit point controls, storm drain inlet protection) that control discharges from the initial site clearing, grading, excavating, and other land-disturbing activities.

- 3.4.4.2 Following the installation of these initial controls, all other stormwater controls planned for this portion of the site and described in the SWPPP shall be installed and made operational as soon as site conditions allow. The requirement to install stormwater controls prior to earth disturbance for each phase of the project does not apply to the earth disturbance associated with the actual installation of these controls.
- 3.4.4.3 The operator shall install all stormwater controls in accordance with good engineering practices, including applicable design specifications. Design specifications may be found in manufacturer specifications and/or in applicable erosion and sediment control manuals or local ordinances. Any departures from such specifications shall reflect good engineering practice and shall be explained in the SWPPP.
- 3.4.5 The operator shall control stormwater discharges, including both peak flow rates and total stormwater volume, to minimize channel and stream bank erosion and scour in the immediate vicinity of the discharge points.
 - 3.4.5.1 Culvert Stabilization – If culverts are present on the site, the SWPPP shall include measures to sufficiently minimize the threat of erosion at culvert location to prevent the formation of rills and gullies during construction; and
 - 3.4.5.2 Velocity Dissipation Devices – The operator shall place velocity dissipation devices at locations where discharges leave the construction site as necessary to provide a non-erosive flow velocity.

3.5 Erosion and Sediment Controls Required by All Sites

- 3.5.1 **Maintain Natural Buffers** adjacent to surface waters of the State that meet the definition of Waters of the U.S., and direct stormwater to vegetated areas to maximize stormwater infiltration and reduce pollutant discharges, unless infeasible. The operator is not required to enhance the quality of the vegetation that already exists in the buffer, or provide vegetation if none exists. Areas not owned or that are otherwise outside the operational control of the Permittee may be considered areas of undisturbed natural buffer for purposes of compliance with this Part.
 - 3.5.1.1 Provide Natural Buffers or Equivalent Sediment Controls – these requirements only apply when surface water is located within 50 feet of the project’s earth disturbances.
 - 3.5.1.1.1 The operator shall ensure that any discharges to surface waters through the area between the disturbed portions of the property and any surface waters located within 50 feet of the site are treated by an area of undisturbed natural buffer and/or additional erosion and sediment controls in order to achieve a reduction in sediment load estimated to be equivalent to that achieved by a 50-foot natural buffer. Appendix G of EPA’s Construction General Permit may help in providing guidance in determine estimated equivalents.

http://water.epa.gov/polwaste/npdes/stormwater/upload/cgp2012_appendixg.pdf

- 3.5.1.2 Alternatives to Natural Buffers – In areas where it is infeasible to maintain the 50 foot buffer the operator shall:
- 3.5.1.2.1 Document in the SWPPP the reasons why the 50-foot buffer cannot be maintained, and identify the additional erosion and sediment controls selected;
 - 3.5.1.2.2 Preserve as much buffer as possible and design, implement and maintain additional erosion and sediment controls (such as berms, diversion dikes, sediment basins, etc.);
 - 3.5.1.2.3 Ensure that all discharges from the area of the earth disturbance to the natural buffer are first treated by the site's erosion and sediment controls, and use velocity dissipation devices if necessary to prevent erosion caused by stormwater within the buffer;
 - 3.5.1.2.4 Document in the SWPPP the natural buffer width retained on the property, and show the buffer boundary on the site plan;
 - 3.5.1.2.5 Delineate, and clearly mark off with flags, tape or other similar marking device, all natural buffer areas; and
 - 3.5.1.2.6 Follow the additional stabilization requirements described in Part 3.6.2.
- 3.5.1.3 Exceptions –
- 3.5.1.3.1 If there is no discharge of stormwater to perennial waters through the area between the site and any perennial waters located within 50 feet of the site, the operator is not required to comply with the requirements of this Part. This includes situations where control measures, such as a berm or other barrier that will prevent such discharges, have been implemented.
 - 3.5.1.3.2 Where no natural buffer exists due to pre-existing development disturbances (e.g., structures, impervious surfaces) that occurred prior to the initiation of planning for the current development of the site, operators are not required to comply with the requirements in this Part, unless portions of the pre-existing development are removed.
 - 3.5.1.3.3 Where some natural buffer exists but portions of the area within 50 feet of the perennial water are occupied by preexisting development disturbances, operators are required to comply with the requirements in this Part. For the purposes of calculating the sediment load reduction, an operator is not expected to compensate for the reduction in buffer function from the area covered by these pre-existing disturbances.
 - 3.5.1.3.4 If any portion of a pre-existing area will be disturbed during the project, the area disturbed will be deducted from the area treated as natural buffer.
 - 3.5.1.3.5 Linear construction projects are not required to comply with the requirements in this Part if site constraints (e.g., limited right-of-way) prevent the operator

from meeting any of the compliance alternatives in Part 3.5.1.2, provided that, to the extent practicable, the operator limits disturbances within 50 feet of the surface water and/or provides supplemental erosion and sediment controls to treat stormwater discharges from earth disturbances within 50 feet of the surface water. The operator shall also document in the SWPPP the rationale for why it is infeasible to comply with the requirements in Part 3.5.1.2, and describe any buffer width retained and/or supplemental erosion and sediment controls installed.

3.5.1.3.6 “Small residential lot” construction (i.e., a lot being developed for residential purposes that will disturb less than 1 acre of land, but is part of a larger residential project that will ultimately disturb greater than or equal to 1 acre) is exempt from buffer requirements provided that the operator minimizes the discharge of pollutants and complies with the requirements of Part 3.4.

3.5.1.3.7 The following disturbances within 50 feet of surface water are exempt from the requirements in this Part but shall be documented in the SWPPP and on the site map:

3.5.1.3.7.1 Construction approved under a CWA Section 404 permit; or

3.5.1.3.7.2 Construction of a water-dependent structure or water access area (e.g., pier, boat ramp, trail).

3.5.2 **Install Perimeter Controls –**

3.5.2.1 The operator shall install appropriate control measures (e.g., fiber rolls, berms, silt fences, vegetative buffer strips, sediment traps, or equivalent approved sediment controls) along those perimeter areas of the site that will receive stormwater from earth-disturbing activities.

3.5.2.2 For linear projects with rights-of-way that restrict or prevent the use of such perimeter controls, the operator shall maximize the use of perimeter controls where practicable and document in the SWPPP why it is impracticable in other areas of the project.

3.5.3 **Minimize Sediment Track-Out** – The operator shall implement effective control measures (e.g., stone/rip rap pad, concrete or steel wash racks, or other NDEP approved systems) to minimize tracking of sediments, debris and other pollutants from vehicles and equipment leaving the site. To comply with this requirement the operator shall:

3.5.3.1 Restrict vehicle use to properly designated exit points;

3.5.3.2 Use appropriate stabilization techniques at all points that exit onto paved roads so that sediment removal occurs prior to vehicle exit;

3.5.3.3 Where necessary, use additional controls to remove sediment from vehicle tires prior to exit; and

3.5.3.4 Where sediment has been tracked-out from the site onto the surface of off-site streets, other paved areas, and sidewalks, the deposited sediment shall be removed by the end of the same work day in which the track-out occurs or by the end of the next work day if the track-out occurs on a non-work day. Track-out shall be removed by sweeping, shoveling, or vacuuming these surfaces, or by using other similarly

effective means of sediment removal. Hosing or sweeping tracked-out sediment into any stormwater conveyance, without appropriate control measures in place, is strictly prohibited.

- 3.5.3.5 If site conditions make it infeasible to install structural controls to prevent track-out (e.g., linear project along a paved right-of-way), the operator shall explain in the SWPPP why such controls cannot be installed and what alternative measures will be used to prevent, monitor and remove track-out sediment from paved roadways.
- 3.5.4 **Control Discharges from Stockpiled Sediment or Soil** – As necessary, implement the following measures for any stockpiled or land clearing debris composed, in whole or in part, of sediment or soil:
 - 3.5.4.1 Place stockpiles away from stormwater conveyances, such as curb and gutter systems, and streets leading to such conveyances. If placement is infeasible, install appropriate sediment controls and document the reasons in the SWPPP;
 - 3.5.4.2 Locate the piles outside of any buffers implemented in accordance with Part 3.5.1;
 - 3.5.4.3 Protect piles from contact with stormwater (including run-on) using a temporary sediment barrier or other protective means;
 - 3.5.4.4 Do not hose down or sweep soil or sediment accumulated on pavement or other impervious surfaces into any stormwater conveyance, storm drain inlet, or surface water leading to a Water of the State Nevada that meets the definition of Waters of the United States; and
 - 3.5.4.5 Unless infeasible, contain and securely protect from wind.
- 3.5.5 **Discharge of Sediments during Dry Weather** – The operator shall implement effective control measures that minimize the discharge of sediment from construction activities to any water body, including dry washes, during dry weather.
- 3.5.6 **Minimize the Disturbance of Steep Slopes** – Where practicable, implement standard erosion and sediment control practices, such as phasing disturbances to these areas and using stabilization practices designed to be used on steep grades.
- 3.5.7 **Minimize Soil Compaction and Preserve Topsoil** – The operator shall minimize soil compaction and, unless infeasible, preserve topsoil for re-vegetation.
 - 3.5.7.1 In areas of the site where final vegetative stabilization will occur or where infiltration practices will be installed, the operator shall either:
 - 3.5.7.1.1 Restrict vehicle and equipment use in these locations to avoid soil compaction; or
 - 3.5.7.1.2 Prior to seeding or planting areas of exposed soils that have been compacted, use techniques that condition the soils to support vegetative growth, if necessary and feasible.
 - 3.5.7.2 Minimizing soil compaction is not required where the intended function of a specific area of the site dictates that it be compacted.
 - 3.5.7.3 Preserving topsoil is not required where the intended function of a specific area of

the site dictates that the topsoil be disturbed or removed.

3.5.8 **Storm Drain Inlet Protection** – For discharge to any storm drain inlet that carries stormwater flow from the site directly to surface water (and it is not first directed to a sediment basin, sediment trap, or similarly effective control), **where the operator has authority to access the storm drain inlet**, the operator shall:

3.5.8.1 Install inlet protection measures that remove sediment from the discharge prior to entry into the storm drain inlet; and

3.5.8.2 Clean, or remove and replace, the protection measures as sediment accumulates, the filter becomes clogged, and/or performance is compromised.

3.5.8.3 Public Safety – Inlet protection measures can be removed in the event of flooding conditions or to prevent erosion.

3.5.9 **Preserve Natural Vegetation** – Where practicable, existing vegetation should be preserved. If natural vegetation can be preserved, the operator shall clearly mark vegetation before clearing activities begin. Locations of trees and boundaries of environmentally sensitive areas and buffer zones to be preserved shall be identified on the SWPPP site map.

3.6 Site Stabilization Requirements, Schedules and Deadlines

3.6.1 The operator shall, at a minimum, initiate soil stabilization measures immediately whenever any clearing, grading, excavating, or other earth disturbing activities have permanently ceased on any portion of the site, or temporarily ceased on any portion of the site and will not resume for a period exceeding 14 calendar days.

3.6.2 *Temporary Stabilization* – The operator shall provide temporary stabilization, or initiate permanent stabilization, of disturbed areas within 14 calendar days of the most recent land disturbance in areas where construction or support activities have been temporarily suspended or have permanently ceased, except as follows:

3.6.2.1 Where stabilization by the 14th day is precluded by snow cover or frozen ground conditions, stabilization measures shall be initiated as soon as practicable;

3.6.2.2 Where disturbed areas are awaiting vegetative stabilization for periods greater than 14 calendar days, non-vegetative methods of stabilization shall be employed. These methods shall be described in the SWPPP.

3.6.2.3 In arid areas (areas with an average annual precipitation of 0-10 inches), semi-arid areas (areas with an average annual precipitation of 10-20 inches), and areas experiencing drought, where initiating vegetative stabilization measures immediately is infeasible, alternative stabilization measures shall be employed and vegetative or final stabilization measures shall be initiated as soon as practicable.

3.6.3 *Final Stabilization* – Final stabilization means the operator has achieved one of the following conditions:

3.6.3.1 All soil disturbing activities at the site have been completed; all construction materials, waste and temporary erosion and sediment control measures (including any sediment that was being retained by temporary erosion and sediment control

measures) have been removed and properly disposed of; and

3.6.3.1.1 A uniform (i.e., evenly distributed, without large bare areas) annual and/or perennial vegetative cover with a density of 70% of the native background vegetative cover for the area is in place on all unpaved areas and areas not covered by permanent structure, or

3.6.3.1.2 Equivalent permanent stabilization measures (such as the use of riprap, gabions, gravel, geotextiles, or other NDEP approved methods) have been employed.

Note: When preconstruction native background vegetation covered less than 100% of the ground (i.e., arid areas, beaches), the 70% coverage criteria is adjusted as follows: if the native vegetation covered 50% of the ground, 70% of 50% (.70 x .50 = .35) or 35% cover density would be required.

3.6.3.2 For individual lots in residential construction, final stabilization means that the homebuilder:

3.6.3.2.1 Has completed final stabilization as specified in Part 3.6.3 above; or

3.6.3.2.2 Has established temporary stabilization, including perimeter controls, for an individual lot prior to occupation of the home by the homeowner and has informed the homeowner of the need for, and benefits of, final stabilization.

3.6.3.3 For construction projects on land used for agricultural purposes (e.g., pipelines across crop or range land), final stabilization may be accomplished by returning the disturbed land to its preconstruction agricultural use. Areas disturbed that were not previously used for agricultural activities, such as buffer strips immediately adjacent to waters of the U.S., and areas that are not being returned to their preconstruction agricultural use shall meet the final stabilization criteria in Part 3.6.3 above.

3.7 Pollution Prevention Requirements

3.7.1 These requirements apply to all areas of the construction site and any support activities covered by this permit. The operator shall design, install, implement, and maintain effective pollution prevention measures to minimize the discharge of pollutants. To meet this requirement, the operator shall comply with all of the following:

3.7.1.1 Eliminate certain pollutant discharges from the site (see Part 1.3 Prohibited Discharges);

3.7.1.2 Properly maintain all pollution prevention controls (see Part 3.3 General Maintenance Requirements); and

3.7.1.3 Comply with pollution prevention measures for pollutant generating activities that occur at the site (See Parts 3.7.2 and 3.7.3).

3.7.2 **Minimize the Discharge of Pollutants** – The operator shall minimize the discharge of pollutants from equipment and vehicle washing, wheel washing and other wash waters.

3.7.2.1 *Equipment/Vehicle Washing* – The operator shall minimize the discharge of

pollutants from equipment and vehicle washing and wheel wash water.

- 3.7.2.1.1 Wash waters shall be treated in a sediment basin or an alternative control that provides equivalent or better treatment prior to discharge.
- 3.7.2.2 *Concrete Washout* – The operator shall provide an effective means of eliminating the discharge of water from the washout of concrete.
 - 3.7.2.2.1 Where possible, concrete suppliers should conduct washout activities at their own plants or dispatch facilities.
 - 3.7.2.2.2 If washout is conducted at the construction site, the operator shall employ control measures (e.g., lined pits or portable washouts) to contain and manage on-site concrete washout to prevent discharge.
 - 3.7.2.2.3 The pit or container shall be designed so that no overflows can occur due to inadequate sizing or precipitation.
 - 3.7.2.2.4 Hardened concrete shall be removed and disposed of consistent with handling of other construction waste materials.
- 3.7.2.3 *Washing of Applicators and Containers used for paint or other materials* – The operator shall provide an effective means of eliminating the discharge of wash water from the washout and cleanout of stucco, paint, form release oils, curing compounds and other construction materials.
 - 3.7.2.3.1 All wash water shall be directed into a leak-proof container or leak-proof pit. The container or pit shall be designed so that no overflows can occur due to inadequate sizing or precipitation.
 - 3.7.2.3.2 Any washout or cleanout activities shall be located as far away as possible from surface water and stormwater inlets or conveyances, and, to the extent practicable, areas designated to be used for these activities.
 - 3.7.2.3.3 Liquid waste shall be disposed of in accordance with local and state regulations.
- 3.7.2.4 *Fueling and Maintenance of Equipment or Vehicles* – An operator that conducts fueling and/or maintenance of equipment or vehicles at the site shall provide an effective means of eliminating the discharge of spilled or leaked chemicals, including fuel, from the area where these activities take place.
 - 3.7.2.4.1 Adequate supplies shall be available at all times to handle spills, leaks and disposal of used liquids.
 - 3.7.2.4.2 Drip pans, absorbents or other approved methods shall be used under or around leaky vehicles and equipment.
 - 3.7.2.4.3 Oil and oily wastes shall be disposed of or recycled in accordance with other federal, state, or local requirements.
 - 3.7.2.4.4 Spills shall be cleaned up immediately and the source of the spill eliminated to prevent further discharge.

- 3.7.2.4.5 If applicable, the Spill Prevention Control and Countermeasures (SPCC) requirements in 40 CFR 112 and Section 311 of the CWA shall be complied with.
- 3.7.3 **Building Materials, Chemicals, Products and Waste** – The operator shall minimize the exposure of building materials, building products, construction wastes, trash, landscape materials, fertilizers, pesticides, herbicides, detergents, sanitary waste and other materials present on the site to precipitation and to stormwater. Minimization of exposure is not required in cases where the exposure to precipitation and to stormwater will not result in a discharge of pollutants, or where exposure of a specific material or product poses little risk of stormwater contamination (such as final products and materials intended for outdoor use).
- 3.7.3.1 *Storage, Handling, and Disposal of Construction Products, Wastes and Material* – The operator shall minimize the exposure to stormwater of any of the products, materials, or wastes specified below in this Part. These requirements do not apply to those products or materials that are designed to be exposed to precipitation and stormwater.
- 3.7.3.1.1 Building product storage areas shall provide either (1) cover (e.g., plastic sheeting or temporary roofs) to prevent products from coming in contact with rainwater, or (2) a similarly effective means designed to prevent the discharge of pollutants from these areas.
- 3.7.3.1.2 Pesticides, herbicides, insecticides, fertilizers, and landscape materials shall (1) be covered (i.e. plastic sheeting or temporary roofs) to prevent these chemicals from coming into contact with rainwater, or (2) be provided a similarly effective means to prevent discharge of pollutants from these areas. Application and disposal requirements shall be in accordance with the products registered label.
- 3.7.3.1.3 Diesel fuel, oil, hydraulic fluids and other petroleum products and chemicals shall be stored in water-tight containers and (1) provided cover (e.g. plastic sheeting or temporary roofs) to prevent containers from coming into contact with rainwater or (2) provide similarly effective means designed to prevent the discharge of pollutants from these areas (e.g. spill kits) or provide secondary containment (e.g., spill berms, decks, spill containment pallets).
- 3.7.3.1.4 Hazardous or toxic waste shall be kept separate from construction and domestic waste. Waste shall be stored in sealed containers constructed of suitable materials, and provided cover or secondary containment to prevent spills from being discharged. All containers shall be labeled in accordance with applicable Resource Conservation and Recovery Act (RCRA) requirements and other applicable federal, state and local requirements. Additionally, hazardous or toxic wastes shall be disposed of in accordance with the manufacturer's recommendations and federal, state and local requirements.
- 3.7.3.1.5 Waste containers (e.g. dumpsters or trash receptacles) of sufficient size and number shall be provided for construction and domestic waste.
- 3.7.3.1.6 Portable toilets for sanitary waste shall be positioned outside stormwater flow areas and secured to ensure they will not tip over.

3.8 Dewatering Practices

3.8.1 **Accumulated stormwater** to be removed from excavations, trenches, foundations, vaults or other similar spaces may be discharged if effectively managed by appropriate controls. Dewatering of accumulated stormwater shall meet the following requirements:

3.8.1.1 A flow of 250 gallons per minute (gpm) or less for no more than 30 days;

3.8.1.2 Only uncontaminated non-turbid waters may be discharged without being routed through a control;

3.8.1.3 An oil-water separator or other suitable filtration device that is designed to remove oil, grease or other products shall be used if dewatering water is found to contain these materials;

3.8.1.4 To the extent feasible, vegetated, upland areas of the site shall be utilized to infiltrate dewatering water before discharge. In no case will surface water be considered part of the treatment area; and

3.8.1.5 At all points where dewatering water is discharged, the velocity dissipation requirements of Part 3.4.5.2 shall be complied with.

3.8.2 **Allowable DeMinimis Discharges**, identified in Part 1.2.3, may be discharged if they are effectively managed by appropriate controls and meet the following requirements:

3.8.2.1 The discharge occurs only from a single outfall per permitted site;

3.8.2.2 A flow of 250 gallons per minute (gpm) or less for no more than 30 days;

3.8.2.3 Within 24 hours of commencement of the discharge a sample shall be taken, for the parameters listed in Appendix B of this permit, to ensure the discharge does not contribute to an exceedence of the discharge limits indicated in the table;

3.8.2.4.1 The sample shall be collected after any control measures, including BMPs, and prior to discharge into the receiving water or MS4.

3.8.2.4.1 If the sample analyses indicate an exceedence of the discharge limits indicated in the Appendix B table, the Permittee shall cease the discharge and contact NDEP for additional permitting options.

3.8.2.5 The following DeMinimis discharge information shall be recorded and maintained in the SWPPP to demonstrate compliance with this permit.

3.8.2.5.1 A description of the discharge;

3.8.2.5.2 The beginning and ending dates of the discharge, and

3.8.2.5.3 A copy of the sampling results,

3.9 Water Quality Standards

3.9.1 The Permittee shall control discharges to surface waters, impaired for common construction

related pollutants such as sediment, sediment-related parameters and nutrients (including nitrogen and phosphorus), from the facility as necessary to not cause or contribute to an exceedance of an applicable water quality standard. If at any time the Permittee becomes aware, or NDEP determines, that the facility's discharge causes or contributes to an exceedance of an applicable water quality standard, the Permittee shall take corrective action and report to NDEP as required.

- 3.9.1.1 When discharges are proposed to water quality-impaired waters that are contained in the current 303(d) Impaired Water Body listing issued by the NDEP Bureau of Water Quality Planning, the permittee shall investigate whether discharges from the Permittee's site will contribute to any 303(d) listing. Information for 303(d) listed waters can be found on the following NDEP website:
<http://ndep.nv.gov/bwqp/303dlist2012.htm>
- 3.9.1.2 If a site discharges into a waterbody with an established Total Maximum Daily Load (TMDL), the Permittee shall comply with all applicable TMDL requirements.
- 3.9.1.3 If a TMDL has not been established as described in Part 3.9.1.2 above, the Permittee shall include a section in the SWPPP describing the condition for which the water has been listed. The SWPPP shall also include a demonstration that the BMPs that are selected for implementation will be sufficient to ensure that the discharges will not cause or contribute to an exceedance of an applicable State water quality standard.

4.0 Effluent Limitations Applicable to Sites Using Constructed Stormwater Conveyance Channels or Sediment Basins.

4.1 Constructed Stormwater Conveyance Channels

- 4.1.1 Stormwater conveyance channels shall be designed to avoid un-stabilized areas on the site and to reduce erosion, unless infeasible. Operators shall minimize erosion of channels and their embankments, outlets, adjacent stream banks, slopes, and downstream waters during discharge conditions through the use of erosion controls and velocity dissipation devices within and along the length of any constructed stormwater conveyance channel, and at any outlet to provide a non-erosive flow velocity.

4.2 Sediment Basins

- 4.2.1 If sediment basins are installed the operator shall comply with the following design and maintenance requirements:
 - 4.2.1.1 Provide storage for either the calculated volume of runoff from a 2-year, 24-hour storm event for each disturbed acre drained, or 3600 cubic feet per acre drained;
 - 4.2.1.2 When discharging from the sediment basin, utilize outlet structures that withdraw water from the surface in order to minimize the discharge of pollutants, unless infeasible. If it is determined to be infeasible, support documentation shall be provided in the SWPPP.
 - 4.2.1.3 Prevent erosion of (1) the sediment basin using stabilization controls (e.g., rip-rap or

erosion control blankets), and (2) the inlet and outlet using erosion controls and velocity dissipation devices;

- 4.2.1.4 Sediment basins shall be situated outside of surface waters and any natural buffers established under Part 3.5.1; and
- 4.2.1.5 Basins shall be maintained in effective operating condition and removal of accumulated sediment shall be conducted when design capacity has been reduced by 50%.

5.0 Inspections

5.1 Inspector Qualifications

- 5.1.1 The operator shall provide qualified personnel to perform inspections according to the schedules outlined below. "Qualified Personnel" means a person knowledgeable in the principles and practice of erosion and sediment controls and who possesses the skills to assess conditions at the site that could impact stormwater quality and effectiveness of the control measures selected to manage the quality of the stormwater discharges.

5.2 Routine Site Inspection Procedures

- 5.2.1 Implementation and functioning of the SWPPP shall be verified by inspections. If, during any routine site inspection or any other time, the facility's control measures are found to be inadequate or otherwise not properly operated and/or maintained, the Permittee shall review selection, design, installation, and implementation of the control measures to determine if maintenance and/or modifications are necessary. Modifications shall be documented in the SWPPP and implemented within 7 days following the inspection results or prior to the next storm event, whichever is sooner.
- 5.2.2 The Permittee shall conduct, at a minimum, a routine site inspection once every 7 days and within 24 hours of the end of a 0.5 inch or greater storm event, that includes all areas of the site where construction materials and/or activities are exposed to stormwater discharges authorized by this permit. Routine inspections shall incorporate the following:
 - 5.2.2.1 Disturbed areas and areas used for storage of materials that are exposed to precipitation shall be inspected for evidence of, or potential for, pollutants entering the drainage system;
 - 5.2.2.2 Sediment and erosion control measures identified in the SWPPP shall be observed to ensure that they are operating correctly;
 - 5.2.2.3 Where discharge locations or points are accessible, they shall be inspected to ascertain whether erosion control measures are effective in preventing significant impacts to receiving waters;
 - 5.2.2.4 Where discharge locations are inaccessible, nearby downstream locations shall be inspected to the extent that such inspections are practicable;
 - 5.2.2.5 Locations where vehicles enter or exit the site shall be inspected for evidence of

offsite sediment tracking;

- 5.2.2.6 The effectiveness of non-structural stormwater controls and practices (such as good housekeeping practices and pollution prevention measures) shall be evaluated;
- 5.2.2.7 Site conditions shall be inspected for evidence of, or the potential for, pollutants entering the municipal separate storm sewer; and
- 5.2.2.8 All locations where temporary stabilization measures have been implemented shall be inspected.

5.3 Reduced Inspection Schedule

- 5.3.1 The operator may reduce inspection frequency if the following conditions are met:
 - 5.3.1.1 Land disturbance activities have been suspended and discharges are unlikely based on seasonal rainfall patterns; and
 - 5.3.1.2 The disturbed areas of the site have been temporarily stabilized as described in Part 3.6.2; or
 - 5.3.1.3 Runoff is unlikely due to winter conditions (e.g., site is covered with snow, ice; or frozen ground exists).
- 5.3.2 During a reduced inspection schedule, the operator shall inspect the site at least once every 30 days and within 24 hours of the end of each storm event of 0.5 inch or greater during a 24 hour period. The reduced schedule shall be documented in the SWPPP and the beginning and ending dates of the period noted.
- 5.3.3 For sites where snow cover or frozen ground exists, the site shall be waived from inspection requirements until one month before thawing conditions are expected to result in a discharge if all of the following requirements are met:
 - 5.3.3.1 The project is located in an area where frozen conditions are anticipated to continue for extended periods of time (i.e., greater than 30 days);
 - 5.3.3.2 Land disturbance activities have been suspended; and
 - 5.3.3.3 The beginning and ending dates of the reduced inspection schedule are documented in the SWPPP.

5.4 Routine Facility Inspection Documentation

- 5.4.1 The Permittee shall document the findings of each routine site inspection performed and maintain this documentation onsite with the SWPPP. At a minimum, the documentation for each routine facility inspection shall include:
 - 5.4.1.1 The inspection date and time;
 - 5.4.1.2 The name(s) and signatures(s) of the inspector(s);
 - 5.4.1.3 Weather information for the period since the last inspection and a description of any

- discharges occurring at the time of the inspection;
- 5.4.1.4 Location(s) of discharges of sediment or other pollutants from the site;
- 5.4.1.5 Any control measures needing maintenance or repairs;
- 5.4.1.6 Any control measures that failed to operate as designed or proved inadequate for a particular location;
- 5.4.1.7 Discussion describing the reason(s) for any failed control measure;
- 5.4.1.8 Any observations of deviations from the permit or SWPPP; and
- 5.4.1.9 Locations where additional control measures are needed to comply with the permit requirements;

5.5 Inspection Results

- 5.5.1 Actions taken based on inspection results shall be recorded and retained as part of the SWPPP. Such reports shall identify any incidents of noncompliance. Where a report does not identify any incidents of noncompliance, the report shall contain a certification that the facility is in compliance with the SWPPP. The report shall be signed in accordance with Part 7.23 of this permit.
- 5.5.2 Inspection reports shall be retained as part of the SWPPP for at least three years from the date that permit coverage is terminated or the site is finally stabilized.

5.6 Inspection Follow-up

- 5.6.1 Based on the findings and observations of the inspection, including the visual assessment, the operator shall implement the changes necessary to comply with the conditions of this permit. The SWPPP shall be updated and modified as needed in accordance with Part 6.4. The changes shall be implemented in accordance with the schedule described in Part 3.3 "General Maintenance Requirements".
- 5.6.2 Based on the scope of the inspection conducted in accordance with 5.0, the operator shall determine and implement appropriate corrective actions, and meet the applicable deadlines and in accordance with the permit.

6.0 Stormwater Pollution Prevention Plan (SWPPP)

6.1 General SWPPP Information

- 6.1.1 The Permittee shall prepare a SWPPP for the site before submitting a Notice of Intent (NOI) for permit coverage. If the Permittee prepared a SWPPP for coverage under the previous NPDES permit, they shall review and update the SWPPP to implement all provisions of this permit within 120 days of the General Permit NVR100000 issuance date. The SWPPP documentation requirements are intended to guide the identification of stormwater pollution sources and the reduction of their impacts, and otherwise lead to compliance with the

conditions of this permit.

6.1.2 The SWPPP shall be prepared and implemented in accordance with good engineering practices and shall:

6.1.2.1 Identify all potential sources of pollution that may reasonably be expected to affect the quality of stormwater discharges from the construction site;

6.1.2.2 Identify, describe, and ensure implementation of control measures that will be used to reduce pollutants in stormwater discharges from the construction site;

6.1.2.3 Ensure compliance with the terms and conditions of this permit; and

6.1.2.4 Be consistent with applicable State and/or local waste disposal, sanitary sewer, or septic system regulations to the extent these are located within the permitted area.

6.1.3 All operator(s) shall sign and certify the SWPPP in accordance with the signatory requirements Part 7.23.

6.1.4 The operator shall implement the SWPPP from initial commencement of the construction activity until final stabilization is complete and a Notice of Termination (NOT) is filed, or an NOT transferring the site to a new operator is received by NDEP.

6.1.5 SWPPPs that do not meet all the provisions of this permit are considered incomplete. Operating under an incomplete or inadequate SWPPP is a violation of this permit.

6.2 SWPPP Contents

6.2.1 *Identification of Operator(s)* – The SWPPP shall identify (by name, title, and contact number) the operator(s) for the project site. If there is more than one operator the SWPPP shall identify the areas and phases over which each operator has control.

6.2.2 *Stormwater Team* – Each operator or group of operators shall assemble a “stormwater team”, which is responsible for overseeing the development of the SWPPP, any modifications to the SWPPP, and compliance with the requirements of this permit. The SWPPP shall identify the team members by name, title and individual responsibilities. The team may include members who are not employed by the operator (i.e., third party consultants)

6.2.3 *Nature of Construction Activities* – The SWPPP shall describe the nature of the construction activities, including the size of the property (in acres) and the total area expected to be disturbed by the construction activities (in acres), construction support activity areas covered by this permit (see Part 1.2.1.3), and the maximum area expected to be disturbed at any one time.

6.2.3.1 *Emergency Related Construction Activities* – For earth-disturbing activities in response to a public emergency (see Part 2.5), the Permittee must document the cause of the public emergency (e.g., natural disaster, extreme flooding conditions, etc.), information substantiating its occurrence (e.g., state disaster declaration or similar state or local declaration), and a description of the construction necessary to reestablish effected public services.

6.2.4 *Sequence and Estimated Dates of Construction Activities* – The SWPPP shall include a

description of the intended sequence of construction activities, including a schedule of the estimated start dates and the duration of the activity for the following activities:

- 6.2.4.1 Installation of stormwater control measures, and when they will be made operational, including an explanation of sequence and schedule for installation of stormwater control measures;
- 6.2.4.2 Commencement and duration of construction activities, including clearing and grubbing, grading, site preparation (i.e., excavating, cutting, and filling), final grading, and creation of soil and vegetation stockpiles requiring stabilization;
- 6.2.4.3 Cessation, temporarily or permanently, of construction activities on the site, or in designated portions of the site;
- 6.2.4.4 Final or temporary stabilization of areas of exposed soil. The dates for stabilization shall reflect the applicable deadlines in Part 3.6; and
- 6.2.4.6 When departures from initial projections are necessary, this shall be documented in the SWPPP itself or in associated records, as appropriate.
- 6.2.5 *Site Description* – The SWPPP shall describe the construction site, including:
 - 6.2.5.1 The project name and location including address, city, county and at least one APN associated with the project;
 - 6.2.5.2 A description of the site and its intended use after the NOT is filed (e.g., low density residential, shopping mall, highway, etc.);
 - 6.2.5.3 The total area of the site, and estimate of the total area of the site expected to be disturbed by construction activities, including off-site supporting activities, borrow and fill areas, staging and equipment storage areas;
 - 6.2.5.4 The percentage of the site that is impervious before and after construction;
 - 6.2.5.5 A description of soils at the site including the potential for erosion;
 - 6.2.5.6 For areas where it is infeasible to maintain a 50-foot buffer in accordance with Part 3.5.1, a description of which alternative was selected for the site, and any additional required documentation;
 - 6.2.5.7 Identification and description of all material storage areas (on-site and off-site) including overburden, stockpiles of dirt, borrow areas, etc.; and
 - 6.2.5.8 A general location map (e.g., USGS quadrangle map, a portion of a city or county map or other map) with enough detail to identify the following:
 - 6.2.5.8.1 The location of the construction site and one-mile radius; and
 - 6.2.5.8.2 The waters of the State of Nevada including tributaries within a one-mile radius of the site.
- 6.2.6 *Site Map(s)* – The SWPPP shall contain a legible site map or series of maps completed to scale showing the entire site that identifies all of the following:

- 6.2.6.1 Topography of the site, existing types of cover (e.g., forest, pasture, pavement, structures), and drainage pattern(s) of flow onto, over, and from the site both before and after major grading activities;
- 6.2.6.2 Areas of soil disturbance and areas that will not be disturbed. Boundaries of the property and locations where construction activities will occur, including:
 - 6.2.6.2.1 Locations where construction activities will occur, noting any phasing;
 - 6.2.6.2.2 Locations where sediment or soil will be stockpiled;
 - 6.2.6.2.3 Locations of any crossings of surface waters;
 - 6.2.6.2.4 Designated points on the site where vehicles will exit onto paved road; and
 - 6.2.6.2.5 Locations of construction support activity areas covered by this permit;
- 6.2.6.3 Locations of temporary and permanent stormwater control measures identified in the SWPPP;
- 6.2.6.4 Locations where stabilization control measures are expected to occur;
- 6.2.6.5 Areas protected by buffers (i.e., either the 50-foot buffer or other buffer areas retained on site when within 50 feet of perennial water) consistent with Part 3.5.1. The site map shall show the boundary line of all such buffers;
- 6.2.6.6 Locations of on-site material, waste, borrow areas or equipment storage areas, and other supporting activities (per Part 1.2.1.3);
- 6.2.6.7 Locations of all potential pollutant-generating activities identified in Part 6.2.9;
- 6.2.6.8 Locations of all surface waters and any impaired waters within ¼ mile of the site;
- 6.2.6.9 Stormwater discharge location(s), using arrows to indicate discharge direction(s) that include the following:
 - 6.2.6.9.1 Location(s) where stormwater and/or allowable non-stormwater discharges are discharged to a Water of the U.S.; and
 - 6.2.6.9.2 Location(s) of any discharges to municipal separate storm sewer systems (MS4s) from the construction site.
 - 6.2.6.9.3 Areas where final stabilization has been accomplished and no further construction permit requirements apply; and
 - 6.2.6.9.4 Location of trees and boundaries of environmentally sensitive areas and buffer zones to be preserved.
- 6.2.7 *Receiving Waters* – the SWPPP shall identify the name of the receiving water(s) and the areal extent and description of wetland or other special aquatic sites at or near the site which will be disturbed or which will receive discharges from disturbed areas of the construction site.
 - 6.2.7.1 If any discharge point from the construction site is within ¼ mile of impaired water,

the SWPPP shall identify any common construction related pollutants such as sediment, sediment-related parameters and nutrients (including nitrogen and phosphorus) listed on the 303(d) list that may potentially be discharged from the construction site and describe additional or enhanced control measures to minimize discharges of these pollutants.

- 6.2.8 *Stormwater Control Measures to be used During Construction Activity* – The SWPPP shall describe all control measures as required in Part 3.0 that will be implemented and maintained as part of the construction project to control pollutants in discharges. The SWPPP shall clearly describe for each major activity identified:
- 6.2.8.1 The appropriate control measures and the general timing (or sequence) during the construction process that the measure will be implemented; and
 - 6.2.8.2 Which operator is responsible for implementation of the control measures.
- 6.2.9 *Summary of Potential Pollutant Sources* – The SWPPP shall identify the location of and describe any pollutant sources, including any non-stormwater discharges expected to be associated with the project, from areas other than construction (i.e., support activities including stormwater discharges from dedicated asphalt or concrete plants and any other non-construction pollutant sources such as fueling and maintenance operations, materials stored on-site, waste piles, equipment staging yards, etc.)
- 6.2.10 *Spill Prevention and Response Procedures* – The SWPPP shall describe procedures to prevent and respond to spills, leaks, and other releases including:
- 6.2.10.1 Procedures for plainly labeling containers (e.g., “Used Oil”, “Pesticides”, etc.) that could be susceptible to spillage or leakage to encourage proper handling and facilitate rapid response as spills or leaks occur;
 - 6.2.10.2 Preventative measures such as barriers between material storage and traffic areas, secondary containment provisions, and procedures for material storage and handling;
 - 6.2.10.3 Procedures for expeditiously stopping, containing, and cleaning up spills, leaks, and other releases. Identify the name or position of the employee(s) responsible for detection and response of spills or leaks; and
 - 6.2.10.4 Procedures for notification of appropriate facility personnel, emergency response agencies, and regulatory agencies where a leak, spill, or other release containing a hazardous substance or oil in an amount equal to or in excess of a reportable quantity established under either 40 CFR Part 110, 40 CFR Part 117, or 40 CFR Part 302, occurs during a 24-hour period. Contact information shall be in locations that are readily accessible and available;
 - 6.2.10.5 The operator may reference the existence of other plans, such as the Spill Prevention Control and Countermeasure (SPCC) plans developed for the construction activity under Part 311 of the CWA, or spill control programs otherwise required by NDEP permits for the construction activity, provided that a copy of that other plan is kept with the SWPPP onsite. If an SPCC or other spill prevention plan already exists, the operator may use such plans and incorporate them by reference in the SWPPP.
- 6.2.11 *Waste Management Procedures* – The SWPPP shall describe procedures for handling and

disposing of all wastes generated at the site, including, but not limited to, clearing and demolition debris, sediment removed from the site, construction and domestic waste, hazardous or toxic waste, and sanitary waste.

6.3 Documentation Requirements including Permit Related Records

6.3.1 The Permittee shall keep the following inspection, monitoring, and certification records complete and up-to-date. Retaining these records with the SWPPP (unless otherwise specified below) is necessary to demonstrate compliance with the conditions of this permit.

6.3.1.1 A copy of the signed electronic NOI certification page submitted to NDEP;

6.3.1.2 A copy of the approval letter received from NDEP;

6.3.1.3 A copy of this permit;

6.3.1.4 Descriptions and dates of any incidences of significant spills, leaks, or other releases that resulted in discharges of pollutants in stormwater to a regulated MS4 or waters of the State of Nevada that meet the definition of Waters of the U.S., the circumstances leading to the release and actions taken in response to the release and measures taken to prevent recurrence of such releases;

6.3.1.5 Documentation of repairs of structural control measures, including the date(s) of discovery of areas in need of repair/replacement, date(s) that the structural control measure(s) returned to full function, and the justification for any extended repair schedules;

6.3.1.6 All inspection reports including post storm event inspections;

6.3.1.7 Description of any corrective action taken at the site, including events and dates when problems were discovered and modification occurred;

6.3.1.8 Buffer documentation if the sites disturbance area is located within 50 feet of perennial water;

6.3.1.9 Records of employee training, including the date training was received; and

6.3.1.10 The SWPPP may incorporate by reference the appropriate elements of plans required by other agencies. A copy of the requirements incorporated by reference shall be included as an attachment to the SWPPP.

6.3.1.11 For DeMinimis discharges, a description of the discharge, the beginning and end dates of the discharge, and a copy of the sampling analyses report.

6.3.2 *Post Construction Stormwater Management* – The SWPPP shall include the following documentation:

6.3.2.1 A description of stormwater management control measures that will be installed during the construction process to control pollutants in stormwater discharges after construction has been completed.

6.4 SWPPP Updates and Modification Requirements

- 6.4.1 *Maintaining an Updated SWPPP* – The SWPPP shall be revised as necessary during permit coverage to reflect current conditions and to maintain accuracy. The operator shall make any required amendments to the SWPPP within 7 calendar days whenever:
- 6.4.1.1 There is a change in design, construction, operations, or maintenance at the construction site that may have a significant effect on the discharge of pollutants to the waters of the state of Nevada that meet the definition of waters of the U.S. that has not been previously addressed in the SWPPP; or
 - 6.4.1.2 During inspections, monitoring if required, or investigations by the operator or by local, state, MS4 or federal officials, it is determined the discharges are causing or contributing to water quality exceedences or the SWPPP is ineffective in eliminating or significantly minimizing pollutants in stormwater discharges from the construction site; or
 - 6.4.1.3 There is a change to the stormwater team.
- 6.4.2 *Conditions Requiring SWPPP Modification* – The operator shall complete required revisions to the SWPPP within 7 calendar days following the occurrence of any of the conditions listed below. The operator shall modify the SWPPP, including the site map(s), in response to any of the following conditions:
- 6.4.2.1 Whenever new operators become active in construction activities on the site, or changes are made to construction plans, stormwater control measures, pollution prevention measures, or other activities at the site that are no longer accurately reflected in the SWPPP. This includes changes made in response to corrective actions;
 - 6.4.2.2 To reflect areas on the site map where operational control has been transferred (and the date of transfer) since initiating permit coverage;
 - 6.4.2.3 If inspections or investigation by site staff, or by local, state or federal officials, determine that SWPPP modifications are necessary for compliance with this permit;
 - 6.4.2.4 Where NDEP determines it is necessary to impose additional requirements on the discharge, the following shall be included in the SWPPP:
 - 6.4.2.4.1 A copy of any correspondence describing such requirements; and
 - 6.4.2.4.2 A description of the stormwater control measures that will be used to meet such requirements.
 - 6.4.2.5 To reflect any revisions to applicable federal, state, tribal, or local requirements that affect the stormwater control measures implemented at the site.

6.5 Deficiencies in the SWPPP

- 6.5.1 NDEP may notify the permittee at any time that the SWPPP does not meet one or more requirements of this section. The notification shall identify the parts of this permit that are not being met and parts of the SWPPP that require modification. Within fifteen (15) calendar days of receipt of the written notification from NDEP, the operator shall make the

required changes to the SWPPP and submit to NDEP a written certification that the requested changes have been made. NDEP may request a copy of the SWPPP to confirm that all deficiencies have been adequately addressed. NDEP may also take appropriate enforcement action for the period of time the permittee was operating under a plan that did not meet minimum requirements of this permit.

6.6 Procedures for Inspection, Maintenance, and Corrective Action

6.6.1 The SWPPP shall describe the procedures operators will follow for maintaining their stormwater control measures, conducting site inspections, and, where necessary, taking corrective actions, in accordance with Parts 3.0, 4.0, and 5.0, of this permit. The following information shall also be included in the SWPPP:

6.6.1.1 Personnel responsible for conducting inspections;

6.6.1.2 The inspection schedule that will be followed based on whether the site is subject to Part 5.2 or whether the site qualifies for the reduced inspection frequency in Part 5.3;

6.6.1.3 If reducing the inspection frequency in accordance with Part 5.3, the beginning and ending dates of the reduced inspection period; and

6.6.1.4 Any inspection or maintenance checklists or other forms that will be used.

6.6.1.5 The operator shall ensure that all qualified personnel (see Appendix A) review the requirements of this permit. Qualified personnel are responsible for:

6.6.1.5.1 The design, installation, maintenance, and/or repair of stormwater controls (including pollution prevention measures); and

6.6.1.5.2 Conducting inspections as required in Part 5.0.

6.7 SWPPP Review and Making SWPPPS Available

6.7.1 The operator shall retain a copy of the current SWPPP at the site or at an easily accessible location so that it can be made available to NDEP, EPA, or another Federal, State or local agency having stormwater program authority, or the operator of a regulated MS4 receiving discharges from the facility (where applicable), at the time of an onsite inspection or upon request.

7.0 General Permit Conditions

7.1 Annual Fee

7.1.1 In accordance with NAC 445A.268, a discharger who is covered under a general permit shall pay to the Director the applicable nonrefundable annual fee not later than July 1 of each year that the discharger is covered under that permit.

7.1.2 If application/fee for the permit occurs prior to July 1, the permittee shall also submit the

annual renewal fee due on or before July 1 of the same year.

7.2 General Permit Re-issuance for Ongoing Projects

- 7.2.1 The Permittee will be included in the reissued general permit after this general permit expires, or will be informed of other permitting requirements. The Permittee will receive public notice if NDEP determines to reissue the general permit.

7.3 Facilities Operation

- 7.3.1 The Permittee shall at all times maintain in good working order and operate as efficiently as possible all equipment and ancillary BMPs used by the Permittee to achieve compliance with the terms and conditions of this general permit.

7.4 Need to Halt or Reduce Activity Not a Defense

- 7.4.1 It shall not be a defense for the Permittee in an enforcement action that it would have been necessary to halt or reduce the permitted activity, under the Permittee's control, in order to maintain compliance with the conditions of this permit.

7.5 Noncompliance, Unauthorized Discharge, Bypass, and Upset

- 7.5.1 Any diversion, bypass, spill, overflow, upset or discharge of treated or untreated stormwater from stormwater treatment or conveyance facilities under the control of the Permittee is prohibited except as authorized by this permit. In the event the Permittee has knowledge that a diversion, bypass, spill, overflow, upset or discharge not authorized by this permit is imminent, the permittee shall notify NDEP immediately.

- 7.5.1.1 **Bypass**: means the intentional diversion of stormwater from any portion of a control measure.

- 7.5.1.1.1 Bypass is prohibited, and NDEP may take enforcement action against the Permittee for bypass, unless:

- 7.5.1.1.1.1 Bypass was unavoidable to prevent loss of life, personal injury, or severe property damage;

- 7.5.1.1.1.2 There were no feasible alternatives to the bypass. This condition is not satisfied if adequate back-up equipment should have been installed in the exercise of reasonable engineering judgment to prevent a bypass which occurred during normal periods of equipment downtime or preventative maintenance; and

- 7.5.1.1.1.3 The Permittee submitted prior notice at least 10 days before the date of the bypass.

- 7.5.1.1.2 NDEP may approve an anticipated bypass, after considering its adverse effects, if NDEP determines that it will meet the three conditions listed in Part 7.5.1.1.1 above.

- 7.5.1.2 **Upset:** means an exceptional incident in which there is unintentional and temporary noncompliance with technology-based permit effluent limitations because of factors beyond the reasonable control of the Permittee. An upset does not include noncompliance to the extent caused by operational error, improperly designed control measures, inadequate control measures, lack of preventive maintenance, or careless or improper operation.
- 7.5.1.2.1 An upset constitutes an affirmative defense to an action brought for non-compliance with such technology-based permit effluent limitations if the requirements of Part 7.5.1.2.2 below are met.
- 7.5.1.2.2 A Permittee who wishes to establish the affirmative defense of upset shall demonstrate, through properly signed, contemporaneous operating logs or other relevant evidence, that:
- 7.5.1.2.2.1 An upset occurred and that the Permittee can identify the cause(s) of the upset;
- 7.5.1.2.2.2 The permitted site was at the time being properly operated;
- 7.5.1.2.2.3 The Permittee submitted notice of the upset as required under this section; and
- 7.5.1.2.2.4 The Permittee complied with any remedial measures required under Part 7.0.
- 7.5.1.2.3 In selecting the appropriate enforcement option, NDEP shall consider whether or not the noncompliance was the result of an upset. The burden of proof is on the Permittee to establish that an upset occurred.
- 7.5.1.3 There shall be no discharge of substances to Waters of the State that would cause a violation of water quality standards of the State of Nevada.

7.6 Sampling and Analysis

If any samples or measurements are taken pursuant to this permit they shall be representative of the volume and nature of the discharge. Laboratory analyses shall be performed by a State of Nevada certified lab. Results from this lab shall be provided to NDEP.

7.7 Test Procedures

Test procedures for analyses of pollutants shall conform to regulations (40 CFR § 136) published pursuant to Section 304(h) of the Act, under which such procedures may be required, unless other procedures are approved by NDEP.

7.8 Recording the Results

If any measurement or sample is taken pursuant to this permit, the permittee shall record the following information:

- 7.8.1 The exact place, date, and time of sampling;
- 7.8.2 The dates the analyses were performed;

- 7.8.3 The person(s) who performed the analyses;
- 7.8.4 The analytical techniques or methods used; and
- 7.8.5 The results of all required analyses.

7.9 Odors

- 7.9.1 There shall be no objectionable odors resulting from activities authorized by this general permit.

7.10 Removed Substances

- 7.10.1 Solids or other pollutants removed in the course of treatment or control of stormwater shall be disposed of in a manner such as to prevent pollution from such materials from entering any surface water.

7.11 Changes in Discharge

- 7.11.1 All discharges authorized herein shall be consistent with the terms and conditions of this general permit. Any anticipated new discharges at the site which will result in new, different, or increased discharges of pollutants shall be reported to NDEP. Pursuant to NAC 445A.263, the general permit may be modified to specify and limit any pollutants not previously limited.

7.12 Adverse Impact

- 7.12.1 The Permittee shall take all reasonable steps to minimize, to the extent practicable, any adverse impact to receiving waters resulting from noncompliance with this general permit, including such accelerated or additional monitoring as necessary to determine the nature and impact of the non-complying discharge. The Permittee shall carry out such measures, as reasonable, to prevent significant adverse impacts on human health or the environment.

7.13 Right of Entry

- 7.13.1 The Permittee shall allow the Administrator and/or his authorized representatives, upon the presentation of credentials:
 - 7.13.1.1 To enter upon the Permittee's premises where a discharge is or could be located or in which any records are required to be kept under the terms and conditions of the general permit; and
 - 7.13.1.2 At reasonable times, to have access to and copy any records required to be kept under the terms and conditions of this general permit; to inspect any monitoring equipment or monitoring method required in this general permit; and to perform any necessary sampling to determine compliance with the general permit or to sample any discharge.

7.14 Transfer of Ownership or Control

7.14.1 In the event of any change in control or ownership of facilities from which the authorized discharge emanates, the Permittee shall notify the succeeding owner/operator of the existence of this permit by letter, a copy of which shall be forwarded to NDEP. Completion of transfer requires the following actions:

7.14.1.1 Transfer of coverage from one owner/operator to a different owner/operator (e.g., facility sold to a new company): the new owner/operator shall complete and file a Notice of Intent in accordance with Part 2.3, at least 14 days prior to taking over operational control of the facility. The current owner/operator shall file a Notice of Termination within thirty (30) days after the new owner/operator has assumed responsibility for the facility.

7.14.1.2 Name changes for the Permittee (e.g., Company "A" changes name to "BCD, Inc.") may be done by submitting to NDEP a request letter on company letterhead, indicating the facility's assigned permit number and requesting the name change.

7.15 Availability of Reports

7.15.1 Except for data determined to be confidential under NRS 445A.665, all reports prepared in accordance with the terms of this general permit shall be available for public inspection at the office of NDEP. As required by the Act, effluent data shall not be considered confidential. Knowingly making any false statement on any such report may result in the imposition of criminal penalties as provided for in NRS 445A.710.

7.16 Furnishing False Information and Tampering with Monitoring Devices

7.16.1 Any person who knowingly makes any false statement, representation, or certification in any application, record, report, plan or other document filed or required to be maintained by the provisions of NRS 445A.300 to 445A.730, inclusive, or by any general permit, rule, regulation or order issued pursuant thereto, or who falsifies, tampers with or knowingly renders inaccurate any monitoring device or method required to be maintained under the provisions of NRS 445A.300 to 445A.730 inclusive, or by any general permit, rule, regulation or order issued pursuant thereto, is guilty of a gross misdemeanor and shall be punished by a fine of not more than \$10,000 or by imprisonment. This penalty is in addition to any other penalties, civil or criminal, provided pursuant to NRS 445A.300 to 445A.730 inclusive.

7.17 Penalty for Violation of General Permit Conditions

7.17.1 The Permittee shall comply with all conditions of this permit. Any permit non-compliance constitutes a violation of the CWA and is grounds for enforcement action, permit termination, revocation and re-issuance, modification, or denial of a permit renewal application. NRS 445A.675 provides that any person who violates a general permit condition is subject to administrative and judicial sanctions as outlined in NRS 445A.690 through 445A.705.

7.18 General Permit Modification, Suspension or Revocation

7.18.1 After notice and opportunity for a hearing, this general permit may be modified, suspended, or revoked in whole or in part during its term for cause including, but not limited to, the following:

7.18.1.1 Violation of any terms or conditions of this general permit;

7.18.1.2 Obtaining this general permit by misrepresentation or failure to disclose fully all relevant facts; or

7.18.1.3 A change in any condition that requires either a temporary or permanent reduction or elimination of the authorized discharge.

7.19 Liability

7.19.1 Nothing in this general permit shall be construed to preclude the institution of any legal action or relieve the Permittee from any responsibilities, liabilities, or penalties established pursuant to any applicable Federal, State or local laws, regulations, or ordinances.

7.20 Property Rights

7.20.1 The issuance of this general permit does not convey any property rights, in either real or personal property, or any exclusive privileges, nor does it authorize any injury to private property or any invasion of personal rights, nor any infringement of Federal, State or local laws or regulations.

7.21 Records Retention

7.21.1 All records and information resulting from activities performed pursuant to this permit shall be retained for a minimum of three years, or longer if required by NDEP.

7.22 Severability

7.22.1 The provisions of this general permit are severable, and if any provisions of this general permit, or the application of any provisions of this general permit to any circumstance is held invalid, the application of such provision to other circumstances, and the remainder of the general permit, shall not be affected thereby.

7.23 Signature Requirements

7.23.1 All Notices of Intent, Notices of Termination, SWPPPs, reporting forms and document submissions shall be signed by one of the following:

7.23.1.1 A principal executive officer of the corporation (of at least the level of vice president) or his authorized representative who is responsible for the overall operation of the facility for which the discharge described in the application or reporting form originates; or

7.23.1.2 A general partner of the partnership; or

- 7.23.1.3 The proprietor of the sole proprietorship; or
- 7.23.1.4 A principal executive officer, ranking elected official or other authorized employee of the municipal, state or other public facility.
- 7.23.1.5 A duly authorized representative only if:
 - 7.23.1.5.1 The authorization is made in writing by a person described above in Part 7.23.1.1;
 - 7.23.1.5.2 The authorization specifies either an individual or a position within the organization; and
 - 7.23.1.5.3 The written authorization is submitted to the Director.

7.24 Changes to Authorization

- 7.24.1 If an authorization under Part 7.23 is no longer accurate because a different individual or position has responsibility for the overall operation of the facility, a new authorization satisfying the requirements of Part 7.23 shall be submitted to NDEP prior to or together with any reports, information, or application to be signed by an authorized representative.

7.25 Certification Requirements

- 7.25.1 Signatures, Certification Required on Application and Reporting Forms: All applications, reports, or information submitted to the Administrator shall be signed and certified by making the following certification. "I certify under penalty of law, that this document and all attachments were prepared under my direction or supervision in accordance with a system designed to assure that qualified personnel properly gathered and evaluated the information submitted. Based on my inquiry of the person or persons who manage the system, or those persons directly responsible for gathering information, the information submitted is, to the best of my knowledge and belief, true, accurate, and complete. I am aware that there are significant penalties for submitting false information, including the possibility of fine and imprisonment for knowing violations."

7.26 Address for Fee Payment, NOI Certification Page, and Notice of Termination Form

- 7.26.1 NOI Certification pages and NOT applications shall be signed and dated in accordance with Parts 2.3.3.10, 2.8.2, and 8.23 and submitted to NDEP at the address below. Application fees, Annual Fees, and any required reporting documentation shall likewise be sent to the address in Part 7.26.2.
- 7.26.2 **Nevada Division of Environmental Protection
Bureau of Water Pollution Control
901 South Stewart Street, Suite 4001
Carson City, Nevada 89701**

Appendix A
Definitions, Abbreviations and Acronyms

A.1 Definitions

24-hour period – any consecutive 24-hour period

Administrator – means the executive head of the Division (NRS 445A.315).

Anticipated Storm Event – for the purpose of this permit, means any storm event with at least a 30% chance of precipitation as predicted by the National Weather Service for the area local to the construction site.

Best Management Practices (BMPs) – schedules of activities, practices (and prohibitions of practices), structures, vegetation, maintenance procedures, and other management practices to prevent or reduce the discharge of pollutants to Waters of the State of Nevada that meet the definition of Waters of the United States. BMPs also include treatment requirements, operating procedures, and practices to control site runoff, spillage or leaks, sludge or waste disposal, or drainage from raw material storage. See 40 CFR 122.2. In addition, the term shall include erosion and sediment controls, conveyance, stormwater diversion and treatment structures, and any procedure or facility used to minimize, to the extent practicable, the exposure of pollutants to stormwater or remove pollutants from stormwater.

Borrow Areas – the areas where materials are dug or stored for use as fill, either onsite or off-site.

Cationic Treatment Chemical – polymers, flocculants, or other chemicals that contain an overall positive charge. Among other things they are used to reduce turbidity in stormwater discharges by chemically bonding to the overall negative charge of suspended silts and other soil materials and causing them to bind together and settle out. Common examples of cationic treatment chemicals are chitosan and cationic PAM.

Clean Water Act (CWA) – Formerly referred to as the Federal Water Pollution Control Act or Federal Water Pollution Control Act Amendments of 1972, Public Law 92-500, as amended by Public Law 92-217, Public Law 95-576, Public Law 96-483 and Public Law 97-117, 33 U.S.C.1251 et seq. CWA and regulations means the Clean Water Act (CWA) and applicable regulation promulgated thereunder. In the case of an approved State program, it includes State program requirements.

Commencement of construction activities – the initial disturbance of soils (or “breaking ground”) associated with clearing, grading, excavating, or stockpiling of fill material activities or other construction related activities.

Common Plan of Development – a contiguous area where multiple separate and distinct land disturbing activities may be taking place at different times, on different schedules, but under one plan. A ‘plan’ is broadly defined to include design, permit application, advertisement or physical demarcation indicating that land disturbing activities may occur.

Construction Activity – includes clearing, grading excavating, stockpiling of fill material and other similar activities. This definition encompasses both large construction activities defined in 40 CFR 122.26(b)(14)(x) and small construction activities in 40 CFR 122.26(b)(15)(i) and include construction support activities.

Construction and Development Effluent Limitations and New Source Performance

Standards (C&D Rule) – as published in 40 CFR § 450 is the regulation requiring effluent limitations guidelines (ELGs) and new source performance standards (NSPS) for controlling the discharge of pollutants from construction sites.

Construction Site (or site) – means the land or water area where construction activities will occur, including construction support activities, and where stormwater controls will be installed and maintained. The construction support activities may be located at a different part of the property from where the primary construction activity will take place, or on a different piece of property altogether.

Construction Support Activity – means a construction related activity that exclusively supports the construction activity and involves earth disturbance or pollutant-generating activities of its own, and can include activities associated with concrete or asphalt batch plants, equipment staging yards, material storage areas, excavated material disposal areas, and borrow areas.

Construction Waste – refers to discarded material (such as packaging materials, scrap construction materials, masonry products, timber, steel, pipe, and electrical cuttings, plastics and Styrofoam).

Control Measure – refers to any BMP or other method (including effluent limitations) used to prevent or reduce the discharge of pollutants to Waters of the State of Nevada that meet the definition of Waters of the United States.

Conveyance Channel – means a temporary or permanent waterway designed and installed to safely convey stormwater flow within and out of a construction site.

Corrective Action – for the purpose of this permit, any action taken to (1) modify or replace any stormwater control used at the site; (2) clean up and dispose of spills, releases, or other deposits found on the site; or (3) remedy a permit violation.

Department - means the State Department of Conservation and Natural Resources (NRS 445A.330).

Director – means the Director of the Nevada Division of Environmental Protection or an authorized representative (NRS 445A.340).

Discharge – means any addition of a pollutant or pollutants to Waters of the State of Nevada that meet the definition of Waters of the United States or to a MS4 from any point source.

Discharge of a pollutant – any addition of any “pollutant” or combination of pollutants to “waters of the United States” from any “point source,” or any addition of any pollutant or combination of pollutants to the waters of the “contiguous zone” or the ocean from any point source other than a vessel or other floating craft which is being used as a means of transportation. This includes additions of pollutants into waters of the United States from surface runoff which is collected or channeled by man. See 40 CFR 122.2.

Discharge Point – is, for the purpose of this permit, the location where stormwater flows exit the construction site.

Discharge to an Impaired Water – for the purposes of this permit, a discharge to an impaired water occurs if the first water of the U.S. to which you discharge is identified by NDEP, pursuant to section 303(d) of the Clean Water Act, as not meeting an applicable water quality standard. For

discharges that enter a storm drain system prior to discharge, the first surface water to which you discharge is the water body that receives the stormwater discharge from the storm drain system.

Division – means the Division of Environmental Protection of the Department (NRS 445A.350)

Domestic Waste – for the purpose of this permit means typical household trash, garbage or rubbish items generated by construction activities.

Emergency-related Construction Activity – means an activity initiated in response to an emergency (e.g., natural disaster, disruption in essential public services), for which the related work requires immediate authorization to avoid imminent endangerment to human health or the environment, or to reestablish essential public services.

Ephemeral Water – means a surface water that has a channel that is at all times above the water table, and that flows only in direct response to precipitation.

Erosion Control – means temporary or permanent measures to prevent soil particles from detaching and being transported in stormwater.

Existing Discharger – an operator applying for coverage under this permit for discharges authorized previously under an NPDES general or individual permit.

Existing Project – means a construction project that commenced construction activities prior to ADD DATE PERMIT BECOMES EFFECTIVE

Exit points – are any points of egress from the construction site to be used by vehicles and equipment during construction activities.

General Permit – means a permit issued by the Department pursuant to NRS 445A.475 (NRS445A.360).

Impaired Water – waters that have been assessed by NDEP, under the CWA, Section 303(d), as not attaining a water quality standard for at least one designated use, and are listed in Nevada's 2006 303(d) Impaired Waters List. <http://ndep.nv.gov/bwqp/303dlist2012.htm>

Industrial Activity – means temporary concrete, asphalt and material plants which are dedicated exclusively to the permitted construction activity.

Infeasible – means not technologically possible, or not economically practicable and achievable in light of best industry practices.

Large Construction Activity – includes clearing, grading and excavation that results in the disturbance of five acres or more of total land area.

Linear Project – includes the construction of roads, bridges, conduits, substructures, pipelines, sewer lines, towers, poles, cables, wires, connectors, switching, regulating and transforming equipment and associated ancillary facilities in a long, narrow area.

Minimize – to reduce and/or eliminate to the extent achievable using stormwater controls that are technologically available and economically practicable and achievable in light of best industry practices.

Municipal Separate Storm Sewer (MS4) – a conveyance or system of conveyances (including

roads with drainage systems, municipal streets, catch basins, curbs, gutters, ditches, man-made channels, or storm drains);

1. Owned or operated by a State, city, town, borough, county, parish, district, association, or other public body (created by or pursuant to State law) having jurisdiction over disposal of sewage, industrial wastes, stormwater, or other wastes, including special districts under State law such as a sewer district, flood control district or drainage district, or similar entity, or an Indian tribe or authorized Indian tribal organization, or a designated and approved management agency under section 208 of the CWA that discharges to waters of the United States;
2. Designed or used for the collecting or conveying stormwater;
3. Which is not a combined sewer; and
4. Is not part of a Publicly Owned Treatment Works (POTW) as defined at 40 CFR122.2. See 40 CFR 122.26(b)(4) and (b)(7).

Notice of Intent (NOI) – the application to operate under this general permit.

Notice of Termination (NOT) – the application to terminate coverage under this general permit.

Operator – any entity with a stormwater discharge associated with construction activity that meets either of the following two criteria:

1. The person has operational control over the construction plans and specifications, including the ability to make modifications to those plans and specifications; or
2. The person has day-to-day operational control of those activities at a project that are necessary to ensure compliance with the permit conditions (e.g., they are authorized to direct workers at a site to carry out activities required by the permit).

Person – “Person” includes the United States, to the extent authorized by federal law, the State or any agency or institution thereof, any municipality or other political subdivision of this State or any interstate body (NRS 445A.390)

Pollutant – (NRS 445A.400)

1. Means dredged soil, solid waste, incinerator residue, sewage, garbage, sewage sludge, munitions, chemical wastes, biological materials, radioactive materials, heat, wrecked or discarded equipment, rock, sand, cellar dirt and industrial, municipal and agricultural waste discharged into water.
2. Does not mean water, gas or other material which is injected into a well to facilitate production of oil or gas, or water derived in association with oil or gas production and disposed of in a well, if the well is used either for facilitating production or for disposal purposes and if the Department determines that such injection or disposal will not result in the degradation of ground or surface water resources.
3. Does not mean water, gas or other material injected into a well or used to stimulate a reservoir of geothermal resources if the Department determines that the injection or stimulation will not result in the degradation of ground or surface water resources.

Pollution Prevention Measures – refers to stormwater controls designed to reduce or eliminate the addition of pollutants to construction site discharges through analysis of pollutant sources, implementation of proper handling/disposal practices, employee education, and other actions.

Qualified Person or Qualified Personnel – Qualified personnel are those (either the Operator’s employees or outside consultants) who are knowledgeable in the principles and practice of erosion and sediment controls and pollution prevention, who possess the skills to assess conditions at the

construction site that could impact stormwater quality, and the skills to assess the effectiveness of any stormwater controls selected to control the quality of stormwater discharges from the construction activity.

Point Source – means any discernible, confined and discrete conveyance, including but not limited to, any pipe, ditch, channel, tunnel, conduit, well, discrete fissure, container, rolling stock, concentrated animal feeding operation, landfill leachate collection system, vessel or other floating craft from which pollutants are or may be discharged. This term does not include return flows from irrigated agriculture or agricultural stormwater runoff.

Pollution Prevention Measures – means stormwater controls designed to reduce or eliminate the addition of pollutants to construction site discharges through analysis of pollutant sources, implementation of proper handling/disposal practices, employee education, and other actions.

Run-on – means stormwater that drains from land located upslope or upstream from the regulated site in question.

Sediment Control – refers to measures designed to intercept and settle out soil particles that have become detached and transported by water.

Small Construction Activity – includes the disturbance of less than one acre of total land area that is part of a larger common plan of development or sale if the larger common plan will ultimately disturb equal to or greater than one acre. Small construction activity does not include routine maintenance that is performed to maintain the original line and grade, hydraulic capacity, or original purpose of the facility.

Stabilization – means covering or maintaining an existing cover over soil that reduces and minimizes erosion. The use of vegetative and/or non-vegetative cover to prevent erosion and sediment loss in areas exposed through the construction process.

Storm Event – as used in this permit is defined as a precipitation event that results in a measureable amount of precipitation.

Stormwater – means stormwater runoff, snow melt runoff, and surface runoff and drainage. See 40 CFR 122.26(b)(13).

Stormwater Discharges Associated with Construction Activity – refers to a discharge of pollutants in stormwater runoff from areas where soil disturbing activities (e.g., clearing, grading, or excavating), construction materials or equipment storage or maintenance (e.g., fill piles, borrow areas, concrete truck washout, fueling), or other industrial stormwater directly related to the construction process (e.g., concrete or asphalt batch plants) are located. See 40 CFR 122.26(b)(14)(x) and 40 CFR 122.26(b)(15).

Stormwater Pollution Prevention Plan (SWPPP) – a site-specific, written document that, among other things: (1) identifies potential sources of stormwater pollution at the construction site; (2) describes stormwater control measures to reduce or eliminate pollutants in stormwater discharges from the construction site; and (3) identifies procedures the operator will implement to comply with the terms and conditions of the general permit.

Stormwater Team – refers to an individual or group of individuals responsible for oversight of the development and modification of the SWPPP, and oversight of compliance with the permit requirements.

Temporary Stabilization – means a condition where exposed soils or disturbed areas are provided a temporary vegetative and/or non-vegetative protective cover to prevent erosion and sediment loss. Temporary stabilization may include temporary seeding, geotextiles, palliatives, mulches, and other techniques to reduce or eliminate erosion until either final stabilization can be achieved or until further construction activities take place to re-disturb the area. The application of water alone to control dust is not considered a form of temporary stabilization.

Waters of the United States or waters of the U.S. – is defined at 40 CFR §122.2. Discharges to storm drain systems that in turn discharge to Waters of the United States are considered to be discharges to Waters of the United States.

Water Quality Standards – A water quality standard defines the water quality goals of a water body, or portion thereof, by designating the use or uses to be made of the water and by setting criteria necessary to protect the uses. States and EPA adopt water quality standards to protect public health or welfare, enhance the quality of water and serve the purposes of the Clean Water Act.

A.2 Abbreviations and Acronyms

BMP – Best Management Practice

BWPC – Bureau of Water Pollution Control

CFR – Code of Federal Regulations

CWA – Clean Water Act (or Federal Water Pollution Control Act, 33 U.S.C. §1251 et seq)

EPA – Federal Environmental Protection Agency

MS4 – Municipal Separate Storm Sewer System

NDEP – Nevada Division of Environmental Protection

NOI – Notice of Intent

NOT – Notice of Termination

NPDES – National Pollutant Discharge Elimination System

SWPPP – Stormwater Pollution Prevention Plan

USGS – United States Geological Survey

WOUS – Waters of the United States

Appendix B
DeMinimis Discharge Sampling and Limitations

B.1 DeMinimis Discharge Sampling and Limitations Table

Parameters	Discharge Limit - Daily Max	Sample Type
Flow - gallons per minute (gpm)	250	Meter
Total Residual Chlorine - mg/L	0.10	Discrete
Total Dissolved Solids (TDS) - mg/L	Monitor & Record in SWPPP	Discrete
Total Suspended Solids (TSS) - mg/L	Monitor & Record in SWPPP	Discrete
Total Petroleum Hydrocarbon (TPH) (C6 - C40) mg/L ¹	1.0	Discrete
Methyl tert-Butyl Ether (MTBE) - µg/L	20.0	Discrete
Total Nitrogen as N - mg/L	10.0	Discrete
Total Phosphorus as P	Monitor & Record in SWPPP	Discrete
Trichloroethylene (TCE) - µg/L	5.0	Discrete
Tetrachloroethylene (PCE) - µg/L	5.0	Discrete
Benzene - µg/L	5.0	Discrete
Ethyl Benzene - µg/L	100.0	Discrete
Toluene - µg/L	100.0	Discrete
Xylene - µg/L	200.0	Discrete
pH - SU	6.5 - 9.0	Discrete
Turbidity - NTU ²	Monitor & Record in SWPPP	Discrete
Barium - mg/L	2.0	Discrete
Fluoride - mg/L	Monitor & Record in SWPPP	Discrete
Iron - mg/L	1.0	Discrete
Sulfate - mg/L	Monitor & Record in SWPPP	Discrete
Dissolved Oxygen	Monitor & Record in SWPPP	Discrete
Molybdenum - mg/L	6.16	Discrete
Antimony	Monitor & Record in SWPPP	Discrete
Arsenic	Monitor & Record in SWPPP	Discrete
Beryllium	Monitor & Record in SWPPP	Discrete
Boron	Monitor & Record in SWPPP	Discrete
Cadmium	Monitor & Record in SWPPP	Discrete
Calcium	Monitor & Record in SWPPP	Discrete
Copper	Monitor & Record in SWPPP	Discrete
Lead	Monitor & Record in SWPPP	Discrete
Magnesium	Monitor & Record in SWPPP	Discrete
Manganese	Monitor & Record in SWPPP	Discrete
Mercury	Monitor & Record in SWPPP	Discrete
Nickel	Monitor & Record in SWPPP	Discrete
Selenium	Monitor & Record in SWPPP	Discrete

Silver	Monitor & Record in SWPPP	Discrete
Sulfur	Monitor & Record in SWPPP	Discrete
Thallium	Monitor & Record in SWPPP	Discrete
Zinc – total recoverable	Monitor & Record in SWPPP	Discrete
Fecal Coliform - MPN/100 mL	Monitor & Record in SWPPP	Discrete
E Coli - MPN/100 mL	Monitor & Record in SWPPP	Discrete
Hardness (expressed as CaCO ₃) – mg/L	Monitor & Record in SWPPP	Discrete

1. EPA Method 8015B and EPA Method 8260B, extractable and purgeable, C6-C40. Summation must meet permit limit.
2. Turbidity shall be less than or equal to 10 Nephelometric Turbidity Units (NTUs) over the background value of the receiving water.

Appendix B
Notice of Termination (NOT)

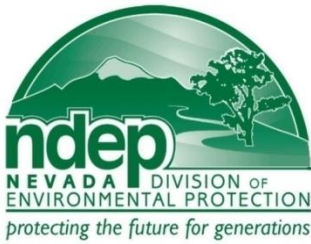

STATE OF NEVADA

Department of Conservation & Natural Resources

Brian Sandoval, Governor

Leo M. Drozdoff, P.E., Director

DIVISION OF ENVIRONMENTAL PROTECTION

Colleen Cripps, Ph.D., Administrator

Notice of Termination (“NOT”) for Coverage under a General National Pollutant Discharge Elimination System (NPDES) Permit

Submission of this NOT constitutes notice that the owner / operator identified below is no longer authorized to discharge under the NPDES General Permit program.

Mail the completed form with original signatures to:

Nevada Division of Environmental Protection
Bureau of Water Pollution Control
901 S. Stewart St., Suite 4001
Carson City, NV 89701

I. PERMIT INFORMATION

Are you filing this NOT due to a change in ownership or operator? Yes No

If yes, stop here. Please refer to the respective General Permit Part “Transfer of Ownership or Control” for appropriate procedures in completing your change of ownership/or operator.

Have all operations associated with this permit been terminated in accordance with applicable permit conditions?

Yes No

If No, provide reason for submission of this Notice of Termination:

Permit Identification Number (e.g. PGP-xxxx, DDP-xxxx, CSW-xxxx, ISW-xxxx, or MSW-xxxx): _____ - _____

Date of Termination: _____

II. SITE OWNER/OPERATOR INFORMATION

Name: _____ Phone: _____

Address: _____

City: _____ State: _____ ZIP Code: _____

Email address: _____

III. NEW SITE OWNER/OPERATOR INFORMATION (If applicable)

Name: _____ Phone: _____

Address: _____

City: _____ State: _____ ZIP Code: _____

Email address: _____

Has a new NOI been submitted? Yes No If yes, what is the new Site ID Number?

(e.g. PGP-xxxx, DDP-xxxx, CSW-xxxx, ISW-xxxx, or MSW-xxxx): ____ - _____

IV. FACILITY/SITE LOCATION INFORMATION

Name: _____ Phone: _____

Address: _____

City: _____ State: _____ ZIP Code: _____

APN: _____

V. CERTIFICATION

“I hereby certify that I am familiar with the information contained in the application and that to the best of my knowledge and ability such information is true, complete, and accurate.”

Print Name: _____

Signature: _____ Date: _____

Any person who knowingly makes any false statement, representation, or certification in any application, record, report, plan, or other document filed or required to be maintained by the provisions of Nevada Administrative Code (NAC) 445A.070 to 445A.348, inclusive, or by any permit, rule, regulation, or order issued pursuant thereto, or who falsifies, tampers with, or knowingly renders inaccurate any monitoring device or method required to be maintained under the provisions of NAC 445A.070 to 445A.348, inclusive, or by any permit, rule, regulation, or order issued pursuant thereto, is guilty of a gross misdemeanor and shall be punished by a fine of not more than \$10,000 or by imprisonment in the county jail for not more than 1 year, or by both fine and imprisonment.

Instructions to Complete the Notice of Termination (NOT) of Coverage under a NPDES General Permit

Who May File a Notice of Termination (NOT) Form?

Permittees who are presently covered under a Nevada-issued National Pollutant Discharge Elimination System (NPDES) General Permit may submit a Notice of Termination (NOT) form when their site/facilities no longer have any discharges activity as defined in the applicable permit, or when they are no longer the operator of the site.

Section I. Permit Information:

If you are filing this NOT because of a change in ownership, **stop here**, and refer to the appropriate General Permit Part: "Transfer of Ownership or Control" for appropriate procedures in completing your change of ownership/or operator.

If all applicable discharges at the facility or site identified in Section III have been terminated, check the "Yes" box. If you are filing the NOT for some other reason, please check the "No" box and indicate the reason for filing the NOT in the space below the boxes.

Enter your existing NPDES General Permit Identification Number (e.g. CSW-xxxx) assigned to the facility/site identified in Section III. If you do not know the permit number, contact NDEP's Bureau of Water Pollution Control for assistance. Enter the date of termination.

Section II. Facility or Site Owner/Operator Information:

Give the legal name of the person, firm, public organization, or any other entity that owns or operates the site described in this NOT. The operator of the facility is the legal entity that controls the site's operation, rather than the plant or site manager. Do not use a colloquial name. Enter the complete contact information of the owner/operator, including mailing address, telephone number and email address.

Section III. New Facility or Site Owner/Operator Information(if applicable):

Give the legal name of the new person, firm, public organization, or any other entity that will own or operate the construction site described in this section. The new operator of the facility is the legal entity that will control the site's operation, rather than the plant or site manager. Do not use a colloquial name. Enter the complete contact information of the new owner/operator, including mailing address, telephone number and email address. The new owner operator should also indicate whether a new NOI has been submitted to NDEP. If this has been done, the new Site Identification Number (e.g. CSW-xxxx) should be added.

Section IV. Facility/Site Location Information:

Enter the site's official or legal name and complete address, including city, state and ZIP code, phone number and Assessor's Parcel Number ("APN") or Latitude and Longitude for site location.

Section V. Certification:

Federal statutes provide for severe penalties for submitting false information on this application form.

Federal regulations require this application to be signed as follows:

- For a corporation: by a responsible corporate officer, which means: (i) president, secretary, treasurer, or vice-president of the corporation in charge of a principal business function, or any other person who performs similar policy or decision making functions, or (ii) the manager of one or more manufacturing, production, or operating facilities employing more than 250 persons or having gross annual sales or expenditures exceeding \$25 million (in second-quarter 1980 dollars), if authority to sign documents has been assigned or delegated to the manager in accordance with corporate procedures;
- For a partnership or sole proprietorship: by a general partner or the proprietor; or
- For a municipality, State, Federal, or other public facility: by either a principal executive officer or ranking.
- All documents submitted to this office must have an original signature(s). Photocopied and faxed documents will not be approved.

Appendix C
Regional Program Stormwater Pollution
Prevention Plan (SWPPP)

Stormwater Pollution Prevention Plan (SWPPP)

Table of Contents

Contents	Page(s)
Site/Owner/Operator Information	1-2
Stormwater Team	3
Nature of Construction Activities	4
Emergency-Related Construction Activities	5
Schedule of Construction Activities	6-7
Site Description	8
Site Map(s)	9
Receiving Waters	10
Stormwater Control Measures	11-13
Potential Pollutant Sources	14-15
Spill Prevention & Response	16-17
Waste Management	18
Documentation Requirements	19-21
Inspection, Maintenance, and Corrective Action	22-23
Additional Information	24-27
Signature Requirements	28-29
Attachments	-

Site / Owner / Operator

Provide site, owner, and operator information.

Site	
ID Number	CSW-
Name	
Address Line 1	
Address Line 2	
City	
State	
Zip Code	
Contact Name	
Phone Number	
Email Address	

Owner	
Name	
Address Line 1	
Address Line 2	
City	
State	
Zip Code	
Contact Name	
Phone Number	
Email Address	

Operator 1	
Name	
Address Line 1	
Address Line 2	
City	
State	
Zip Code	
Contact Name	
Title	
Phone Number	
Email Address	
If there is more than one operator, identify the areas and phases over which Operator 1 has control.	

Operator 2	
Name	
Address Line 1	
Address Line 2	
City	
State	
Zip Code	
Contact Name	
Title	
Phone Number	
Email Address	
Identify the areas and phases over which Operator 2 has control.	

Operator 3	
Name	
Address Line 1	
Address Line 2	
City	
State	
Zip Code	
Contact Name	
Title	
Phone Number	
Email Address	
Identify the areas and phases over which Operator 3 has control.	

Stormwater Team

List the name, title, and individual responsibilities for each member of the stormwater team. The stormwater team is responsible for overseeing the development of the SWPPP, any modifications to the SWPPP, and compliance with the requirements of the Construction Stormwater General Permit NVR100000 (hereinafter referred to as the "Permit"). The team may include members who are not employed by the operator (such as third party consultants).

Stormwater Team Member 1	
Name	
Title	
Responsibilities	

Stormwater Team Member 2	
Name	
Title	
Responsibilities	

Stormwater Team Member 3	
Name	
Title	
Responsibilities	

Stormwater Team Member 4	
Name	
Title	
Responsibilities	

Stormwater Team Member 5	
Name	
Title	
Responsibilities	

Nature of Construction Activities

Describe the nature of the construction activities, including the size of the property and the total area expected to be disturbed by construction activities, construction support activity areas covered by the Permit, and the maximum area expected to be disturbed at any one time.

Nature of Construction Activities

What is the size of the property?	acres
What is the total area expected to be disturbed by construction activities?	acres
What is the maximum area expected to be disturbed at any one time?	acres

Describe the construction support activity areas covered by the Permit. Construction support activities covered by the Permit are described in Permit section 1.2.1.2 and defined on page 40 of the Permit.

Emergency-Related Construction Activities

For earth-disturbing activities in response to a public emergency, document the cause of the public emergency, provide information substantiating its occurrence, and describe the construction necessary to reestablish affected public services.

Cause of the Public Emergency

Describe the cause of the public emergency (e.g., natural disaster, extreme flooding conditions, etc.).

Substantiating Information

Provide information substantiating the occurrence of the public emergency (such as a state disaster declaration or similar state or local declaration). Attach supporting documentation to the end of the SWPPP.

Necessary Construction

Describe the construction necessary to reestablish affected public services.

Sequence and Estimated Dates of Construction Activities

Provide a schedule of the estimated start dates and the duration of the activity for installation of stormwater control measures, construction activities, cessation of construction activities, and stabilization of areas of exposed soil.

Installation of Stormwater Control Measures

What is the estimated start date for the installation of stormwater control measures?

____/____/____

What is the estimated duration of the installation of stormwater control measures?

When will the stormwater control measures be made operational?

Explain the sequence and schedule for installation of stormwater control measures.

Construction Activities

What is the estimated start date of construction activities?

____/____/____

What is the estimated duration of construction activities?

Describe the intended sequence of construction activities. Construction activities include clearing and grubbing, grading, site preparation (i.e., excavating, cutting, and filling), final grading, and creation of soil and vegetation stockpiles requiring stabilization.

Cessation of Construction Activities		
What is the estimated start date for the cessation of construction activities?	_____ / _____ / _____	
Will the cessation of construction activities be temporary or permanent?	Temporary	Permanent
If the cessation of construction activities will be temporary, provide the estimated duration of the cessation of construction activities.		
Will the cessation of construction activities occur on the entire site (100%) or in designated portions of the site?	100%	Designated Portions
If the cessation of construction activities will occur in designated portions of the site, identify the designated portions of the site where the cessation of construction activities will occur.		

Stabilization of Areas of Exposed Soil		
What is the estimated start date for the <i>temporary</i> stabilization of areas of exposed soil?	_____ / _____ / _____	
What is the estimated duration of the <i>temporary</i> stabilization of areas of exposed soil?		
What is the estimated start date for the <i>final</i> stabilization of areas of exposed soil?	_____ / _____ / _____	
What is the estimated duration of the <i>final</i> stabilization of areas of exposed soil?		
Note: The dates for stabilization shall reflect the applicable deadlines in Permit section <u>3.6 Site Stabilization Requirements, Schedules, and Deadlines</u> .		

Departures from Initial Projections
If departures from initial projections for any of the activities on pages 6 and 7 of this SWPPP are necessary, identify and describe such departures. Alternatively, documentation describing such departures may be attached to the end of the SWPPP.

Site Description

Provide the following construction site information.

Site Description					
Project Name					
Project Address					
Project City					
Project County					
Project APN					
Describe the site and its intended use after the Notice of Termination is filed (e.g., low density residential, shopping mall, highway, etc.)					
What is the total area of the site?	acres				
What is the estimated total area of the site expected to be disturbed by construction activities, including off-site supporting activities, borrow and fill areas, and staging and equipment storage areas?	acres				
What percentage of the site is impervious before and after construction?	<table style="width: 100%; border-collapse: collapse;"> <tr> <td style="width: 80%; border: none;">Before:</td> <td style="text-align: right; border: none;">%</td> </tr> <tr> <td style="border: none;">After:</td> <td style="text-align: right; border: none;">%</td> </tr> </table>	Before:	%	After:	%
Before:	%				
After:	%				
Describe the soils at the site, including the potential for erosion.					
For areas where it is infeasible to maintain a 50-foot buffer in accordance with Permit section <u>3.5.1</u> , provide the reasons why the 50-foot buffer cannot be maintained, identify and describe the alternative additional erosion and sediment controls that were selected for the site, document the natural buffer width retained on the property, and attach any relevant documentation to the end of the SWPPP.					
Identify and describe all on-site and off-site material storage areas, including overburden, stockpiles of dirt, borrow areas, etc.					
<p>Attach a general location map to the end of the SWPPP. The map should contain enough detail to identify the following items:</p> <ul style="list-style-type: none"> the location of the construction site and one-mile radius the waters of the State of Nevada, including tributaries, within a one-mile radius of the site 					

Site Map(s)

Attach a site map or series of maps to the end of the SWPPP.

Site Map(s)

Attach, to the end of the SWPPP, a legible site map or series of maps completed to scale. The map(s) should show the entire site and identify all of the items listed below. Check the box next to each item to confirm that the item is identified on the map(s).

	Topography of the site, existing types of cover (e.g., forest, pasture, pavement, structures), and drainage pattern(s) of flow onto, over, and from the site both before and after major grading activities
	Areas of soil disturbance and areas that will not be disturbed
	Boundaries of the property
	Locations where construction activities will occur, noting any phasing
	Locations where sediment or soil will be stockpiled
	Locations of any crossings of surface waters
	Designated points on the site where vehicles will exit onto paved road
	Locations of construction support activity areas covered by the Permit
	Locations of temporary and permanent stormwater control measures identified in this SWPPP
	Locations where stabilization control measures are expected to occur
	Areas protected by buffers (i.e., either the 50-foot buffer or other buffer areas retained on site when within 50 feet of perennial water) consistent with Permit section <u>3.5.1</u> , as well as the boundary line of all such buffers
	Locations of on-site material, waste, borrow areas or equipment storage areas, and other supporting activities (per Permit section 1.2.1.2)
	Locations of all potential pollutant-generating activities identified on pages 14-15 of this SWPPP
	Locations of all surface waters and any impaired waters within ¼ mile of the site
	Stormwater discharge locations, using arrows to indicate discharge directions, including: <ul style="list-style-type: none"> • locations where stormwater and/or allowable non-stormwater discharges are discharged to a Water of the U.S. • locations of any discharges to municipal separate storm sewer systems (MS4s) from the construction site
	Areas where final stabilization has been accomplished and no further construction permit requirements apply
	Location of trees and boundaries of environmentally sensitive areas and buffer zones to be preserved

Receiving Waters

Identify the receiving waters.

Receiving Waters

Identify the name of the receiving water(s) and the areal extent and description of wetland or other special aquatic sites at or near the site which will be disturbed or which will receive discharges from disturbed areas of the construction site.

Impaired Water

Is any discharge point from the construction site within ¼ mile of impaired water?

Yes

No

If any discharge point from the construction site is within ¼ mile of impaired water, identify any common construction-related pollutants, such as sediment, sediment-related parameters, and nutrients (including nitrogen and phosphorous), listed on the 303(d) list that may potentially be discharged from the construction site and describe additional or enhanced control measures to minimize discharges of these pollutants. The 303(d) list can be found on the Nevada Division of Environmental Protection (NDEP), Bureau of Water Quality Planning (BWQP) website (<http://ndep.nv.gov/bwqp/303dlist2012.htm>).

Stormwater Control Measures

Describe the stormwater control measures that will be used during construction activity.

Stormwater Control Measures

Identify and describe all control measures as required by Permit section 3.0 that will be implemented and maintained as part of the construction project to reduce and control pollutants in stormwater discharges from the construction site. Include control measures used at support activity areas.

Control Measure 1

Control Measure 2

Control Measure 3

Control Measure 4

Control Measure 5

Control Measure 6

Stormwater Control Measures for Major Construction Activities

For each major construction activity at the site, describe the appropriate control measures and the general timing (or sequence) during the construction process that the measure will be implemented and identify the operator responsible for implementation of the control measures. Fill out one table for each major construction activity.

Construction Activity 1

Identify the type of construction activity.

Describe the control measure(s) used for this activity.

Describe the general timing/sequence during the construction process that the measure(s) will be implemented.

Which operator is responsible for implementation of this control measure?

Construction Activity 2

Identify the type of construction activity.

Describe the control measure(s) used for this activity.

Describe the general timing/sequence during the construction process that the measure(s) will be implemented.

Which operator is responsible for implementation of this control measure?

Construction Activity 3

Identify the type of construction activity.

Describe the control measure(s) used for this activity.

Describe the general timing/sequence during the construction process that the measure(s) will be implemented.

Which operator is responsible for implementation of this control measure?

Construction Activity 4
Identify the type of construction activity.
Describe the control measure(s) used for this activity.
Describe the general timing/sequence during the construction process that the measure(s) will be implemented.
Which operator is responsible for implementation of this control measure?

Construction Activity 5
Identify the type of construction activity.
Describe the control measure(s) used for this activity.
Describe the general timing/sequence during the construction process that the measure(s) will be implemented.
Which operator is responsible for implementation of this control measure?

Construction Activity 6
Identify the type of construction activity.
Describe the control measure(s) used for this activity.
Describe the general timing/sequence during the construction process that the measure(s) will be implemented.
Which operator is responsible for implementation of this control measure?

Potential Pollutant Sources

Identify and describe any pollutant sources expected to be associated with the project.

Potential Pollutant Sources

Identify all potential sources of pollution that may reasonably be expected to affect the quality of stormwater discharges from the construction site. Also identify the location of and describe any pollutant sources, including any non-stormwater discharges expected to be associated with the project, from areas other than construction (i.e., support activities including stormwater discharges from dedicated asphalt or concrete plants and any other non-construction pollutant sources such as fueling and maintenance operations, materials stored on-site, waste piles, equipment staging yards, etc.).

Potential Pollutant Source 1

What is the location of the potential pollutant source?

Describe the potential pollutant source.

Potential Pollutant Source 2

What is the location of the potential pollutant source?

Describe the potential pollutant source.

Potential Pollutant Source 3

What is the location of the potential pollutant source?

Describe the potential pollutant source.

Potential Pollutant Source 4

What is the location of the potential pollutant source?

Describe the potential pollutant source.

Potential Pollutant Source 5

What is the location of the potential pollutant source?

Describe the potential pollutant source.

Potential Pollutant Source 6

What is the location of the potential pollutant source?

Describe the potential pollutant source.

Potential Pollutant Source 7

What is the location of the potential pollutant source?

Describe the potential pollutant source.

Spill Prevention & Response

Describe procedures to prevent and respond to spills, leaks, and other releases. Other existing spill prevention plans, such as the Spill Prevention Control and Countermeasure (SPCC) plans developed for the construction activity under Part 311 of the Clean Water Act (CWA), or spill control programs otherwise required by NDEP permits for the construction activity, may be referenced provided that a copy of that other plan is kept onsite with the SWPPP. Attach a copy of any referenced plan(s) to the end of the SWPPP.

Container Labeling

Describe procedures for plainly labeling containers (e.g., "Used Oil", "Pesticides", etc.) that could be susceptible to spillage or leakage to encourage proper handling and facilitate rapid response as spills or leaks occur.

Preventive Measures

Describe preventive measures such as barriers between material storage and traffic areas, secondary containment provisions, and procedures for material storage and handling.

Spill/Leak Stoppage, Containment, and Cleaning

Describe procedures for expeditiously stopping, containing, and cleaning up spills, leaks, and other releases.

Identify the name or position of the employee(s) responsible for detecting and responding to spills or leaks.

Spill/Leak Notification

Describe procedures for notification of appropriate facility personnel, emergency response agencies, and regulatory agencies where a leak, spill, or other release containing a hazardous substance or oil in an amount equal to or in excess of a reportable quantity established under 40 Code of Federal Regulations (CFR) Part 110, 40 CFR Part 117, or 40 CFR Part 302, occurs during a 24-hour period. Contact information shall be in locations that are readily accessible and available.

Facility Personnel

Emergency Response Agencies

Regulatory Agencies

Waste Management

Describe procedures for handling and disposing of all wastes generated at the site.

Waste Management Procedures

Describe procedures for handling and disposing of all wastes generated at the site, including, but not limited to, clearing and demolition debris, sediment removed from the site, construction and domestic waste, hazardous or toxic waste, and sanitary waste.

Documentation Requirements

Provide the following information.

Notice of Intent (NOI)

Attach, to the end of the SWPPP, a copy of the signed electronic NOI certification page submitted to the NDEP.

Approval Letter

Attach, to the end of the SWPPP, a copy of the approval letter received from the NDEP.

Permit

Attach a copy of the Permit to the end of the SWPPP.

Significant Spills/Leaks/Releases

Describe any incidences of significant spills, leaks, or other releases that resulted in discharges of pollutants in stormwater to a regulated MS4 or waters of the State of Nevada that meet the definition of Waters of the U.S. Include the date of occurrence, the circumstances leading to the release, actions taken in response to the release, and measures taken to prevent recurrence of such releases.

Structural Control Measure Repairs

Attach, to the end of the SWPPP, documentation of repairs made to structural control measures. Such documentation shall include the date(s) of discovery of areas in need of repair/replacement, date(s) that the structural control measure(s) returned to full function, and the justification for any extended repair schedules.

Inspection Reports

Attach, to the end of the SWPPP, all inspection reports including post-storm event inspections.

Corrective Action

Describe any corrective action taken at the site. Include events and dates when problems were discovered and modification occurred.

Buffer Documentation

If the site's disturbance area is located within 50 feet of perennial water, attach buffer documentation to the end of the SWPPP.

Employee Training Records

Attach records of employee training to the end of the SWPPP. Records should include the date training was received.

Plans Required By Other Agencies

The SWPPP may incorporate by reference the appropriate elements of plans required by other agencies. Attach, to the end of the SWPPP, a copy of the requirements incorporated by reference.

DeMinimis Discharges

For DeMinimis discharges, describe the discharge, provide the beginning and end dates of the discharge, and attach a copy of the sampling analysis report to the end of the SWPPP.

DeMinimis Discharge 1

Start Date
____ / ____ / ____

End Date
____ / ____ / ____

Description

DeMinimis Discharge 2

Start Date
____ / ____ / ____

End Date
____ / ____ / ____

Description

DeMinimis Discharge 3	
Start Date ____ / ____ / ____	Description
End Date ____ / ____ / ____	

Post-Construction Stormwater Management
Describe the stormwater management control measures that will be installed during the construction process to control pollutants in stormwater discharges after construction has been completed.

Inspection, Maintenance, and Corrective Action

Describe the procedures operators will follow for maintaining their stormwater control measures, conducting site inspections, and, where necessary, taking corrective actions, in accordance with Permit sections 3.0 Effluent Limitations Applicable to All Discharges from Construction Sites, 4.0 Effluent Limitations Applicable to Sites Using Constructed Stormwater Conveyance Channels or Sediment Basins, and 5.0 Inspections.

Inspection Procedures

Describe the procedures operators will follow for conducting site inspections.

Identify the personnel responsible for conducting inspections.

Provide the inspection schedule that will be followed based on whether the site is subject to Permit section 5.2 Routine Site Inspection Procedures, or whether the site qualifies for the reduced inspection frequency in Permit section 5.3 Reduced Inspection Schedule. If the site qualifies for a reduced inspection schedule in accordance with Permit section 5.3 Reduced Inspection Schedule, include the beginning and ending dates of the reduced inspection period.

Routine Facility Inspection Documentation

Attach all documented findings of each routine site inspection to the end of the SWPPP. Routine facility inspection documentation requirements are outlined in Permit section 5.4 Routine Facility Inspection Documentation.

Inspection Results

Attach, to the end of the SWPPP, records of actions taken based on inspection results in accordance with Permit section 5.5 Inspection Results.

Inspection or Maintenance Checklists

Attach any inspection or maintenance checklists or other forms that will be used to the end of the SWPPP.

Maintenance Procedures

Describe the procedures operators will follow for maintaining their stormwater control measures.

Corrective Action Procedures

Describe the procedures operators will follow for taking any necessary corrective actions.

Additional Information

Provide the following additional information.

Discharges To Water Quality Impaired Waters

Does the facility discharge to a surface water contained in the current 303(d) <i>Impaired Water Body</i> listing issued by the NDEP BWQP that is impaired for (1) sediment or a sediment-related parameter, such as total suspended solids (TSS) or turbidity, and/or (2) nutrients, including impairments for nitrogen and/or phosphorous?	Yes	No
--	-----	----

If yes, make one of the following demonstrations (check the appropriate box to indicate which one has been selected) and attach such data and technical information to the end of the SWPPP:

	That the site will employ measures to prevent the discharge of stormwater pollutant(s) for which the waterbody is impaired; or
	That the discharge from the site has no potential to contain the pollutants causing impairment; or
	That the discharge is not expected to cause or contribute to an exceedance of an applicable water quality standard.

Control Measure Addition/Repair/Modification

If it is determined, based on an inspection of control measures performed in accordance with the inspection requirements of Permit section 5.0 Inspections, that installation of additional control measures, or significant repair or modification of existing control measures, is necessary, and implementation before the next storm event is impracticable, document the reason(s) for the delay in the area below.

Identify and describe the modifications made to control measures.

Permit Requirement Waiver

If the project is waived from complying with a specific requirement in Permit section 3.0 Effluent Limitations Applicable to All Discharges from Construction Sites in accordance with Permit section 3.1.1, document this fact in the area below.

--

Departures from Design Specifications

Explain any departures from design specifications for the installation of all stormwater control measures.

--

Culvert Stabilization

If culverts are present on the site, describe the measures implemented to sufficiently minimize the threat of erosion at culvert locations to prevent the formation of rills and gullies during construction.

--

Unique Construction Disturbances

If the project involves construction approved under a CWA Section 404 permit or construction of a water-dependent structure or water access area (e.g., pier, boat ramp, trail), document this fact in the area below and on the site map.

--

Linear Construction Projects

For linear construction projects where it is infeasible to comply with the requirements of Permit section 3.5.1.2, document the rationale for why it is infeasible to do so, and describe any buffer width retained and/or supplemental erosion and sediment controls installed.

For linear projects with rights-of-way that restrict or prevent the use of perimeter controls required by Permit section 3.5.2 *Install Perimeter Controls*, identify the areas where it is impracticable to maximize the use of perimeter controls and explain why it is impracticable to do so.

Track-Out

If site conditions make it infeasible to install structural controls to prevent track-out (e.g., linear project along a paved right-of-way), explain why such controls cannot be installed and describe the alternative measures that will be used to prevent, monitor, and remove track-out sediment from paved roadways.

Sediment or Soil Stockpiles

If it is infeasible to place sediment or soil stockpiles away from stormwater conveyances, such as curb and gutter systems, and streets leading to such conveyances, explain why it is infeasible to do so.

Non-Vegetative Stabilization Methods

Describe all non-vegetative methods of stabilization employed at the site.

Discharges to Impaired Waterbodies Without Established Total Maximum Daily Loads

If the site discharges to a water quality-impaired water (contained in the current 303(d) impaired water body listing) for which a Total Maximum Daily Load has not been established, describe the condition for which the water has been listed and include a demonstration that the Best Management Practices that are selected for implementation will be sufficient to ensure that the discharges will not cause or contribute to an exceedance of an applicable State water quality standard.

Sediment Basin Discharges

If the use of outlet structures that withdraw water from the surface of the sediment basin in order to minimize the discharge of pollutants is determined to be infeasible, explain why it is infeasible and attach any supporting documentation to the end of the SWPPP.

Additional Discharge Requirements

Where NDEP determines it is necessary to impose additional requirements on the discharge, attach a copy of any correspondence describing such requirements to the end of the SWPPP, and describe the stormwater control measures that will be used to meet such requirements.

Signature Requirements

Print out the completed SWPPP and sign and date below in accordance with Permit section 7.23 Signature Requirements. All operators shall also sign and certify the SWPPP in accordance with the Permit signature requirements. Digital signatures are not accepted.

Adherence Statement

"I certify under penalty of law, that this document and all attachments were prepared under my direction or supervision in accordance with a system designed to assure that qualified personnel properly gathered and evaluated the information submitted. Based on my inquiry of the person or persons who manage the system, or those persons directly responsible for gathering information, the information submitted is, to the best of my knowledge and belief, true, accurate, and complete. I am aware that there are significant penalties for submitting false information, including the possibility of fine and imprisonment for knowing violations."

Name (print)	Title
Signature	Date
	_____ / _____ / _____

Operator 1

Name (print)	Title
Signature	Date
	_____ / _____ / _____

Operator 2

Name (print)	Title
Signature	Date
	_____ / _____ / _____

Operator 3	
Name (print)	Title
Signature	Date ____/____/____

Appendix D
Regional Program Checklists

TRUCKEE MEADOWS REGIONAL STORMWATER QUALITY MANAGEMENT PROGRAM

CONSTRUCTION PERMIT SUBMITTAL CHECKLIST

(Applies to all Grading, Site Development, Building, and Encroachment Permits and plans including Final, Parcel, Subdivision, Site Drainage and Erosion and Sediment Control Plans)

Total planned area of land disturbance = _____ square feet.

If the area of land disturbance is one acre (43,560 square feet) or more, the applicant must submit a copy of their Notice of Intent (NOI) to Nevada Division of Environmental Protection (NDEP) to be regulated under Stormwater General Permit NVR100000 and submit a copy of the receipt for payment of the annual fee or the letter of authorization from NDEP (address attached). Once payment has been received by NDEP, the applicant is immediately covered under the State's permit.

- 1. Copy of NOI attached
- 2. Copy of receipt or letter of authorization from NDEP attached

By submitting a copy of the NOI and the receipt or authorization from NDEP, the applicant acknowledges that they are aware of the requirements set forth in the State's General Permit and have developed and will implement a site specific Stormwater Pollution Prevention Plan (SWPPP). The applicant further acknowledges that they are aware the Truckee Meadows Construction Site Best Management Practices Handbook and the required performance standards set forth in Section 3.2 of the handbook. To ensure compliance with these performance standards, the applicant shall submit a completed Performance Standards Compliance Checklist, indicating the BMPs that implement standards 1 – 16. It is recommended that the applicant also attach a copy of the checklist to their SWPPP.

- Copy of Performance Standards Compliance Checklist attached

Yes No

In addition to the submittal requirements specified above and in the ordinances, the following shall be included as a set of standard notes to be depicted on all site plans that disturb one acre or larger.

1. Standard Note No. 1: The Owner, Site Developer, Contractor and/or their authorized agents shall each day remove all sediment, mud, construction debris, or other potential pollutants that may have been discharged to, or accumulate in, the public rights of ways of the _____ *[insert applicable jurisdiction]* as a result of construction activities associated with this site development or construction project. Such materials shall be prevented from entering the storm sewer system.
2. Standard Note No. 2: Additional construction site discharge best management practices may be required of the owner and his or her agents due to unforeseen erosion problems or if the submitted plan does not meet the performance standards specified in the _____ *[insert*

jurisdiction's ordinance reference] and the Truckee Meadows Construction Site Best Management Practices Handbook.

3. Standard Note No. 3: Temporary or permanent stabilization practices will be installed on disturbed areas as soon as practicable and no later than 14 days after the construction activity in that portion of the site has temporarily or permanently ceased. Some exceptions may apply; refer to Stormwater General Permit NVR100000.

4. Standard Note No. 4: At a minimum, the Contractor or his agent shall inspect all disturbed areas, areas used for storage of materials and equipment that are exposed to precipitation, vehicle entrance and exit locations and all BMPs weekly, prior to a forecasted rain event and within 24 hours after any actual rain event. The Contractor or his agent shall update or modify the Stormwater Pollution Prevention Plan as necessary. Some exceptions to weekly inspections may apply, such as frozen ground conditions or suspension of land disturbance activities. Refer to Stormwater General Permit NVR100000.

5. Standard Note No. 5: Accumulated sediment in BMPs shall be removed within seven days after a stormwater runoff event or prior to the next anticipated storm event whichever is earlier. Sediment must be removed when BMP design capacity has been reduced by 50 percent or more.

Owner / Operator (applicant) Information

Name: _____ Phone: _____

Address: _____

City: _____ State: _____ Zip Code: _____

Project Name: _____

Project Address/Location: _____

Signature: _____ Date: _____

To submit a Notice of Intent (NOI), go to http://ndep.nv.gov/bwpc/storm_cont03.htm or contact:

The Nevada Division of Environmental Protection
Bureau of Water Pollution Control
901 South Stewart Street, Suite 4001
Carson City, NV 89701
Phone: (775) 687-9429
Fax: (775) 687-4684
Current Contacts: Mr. Chris Gravenstein or Ms. Mickie Reid

Truckee Meadows Regional Stormwater Quality Management Program

Performance Standards Compliance Checklist

The checklist that follows identifies the BMPs that can be used at construction sites to meet each of the Performance Standards of the Truckee Meadows Construction Site Best Management Practices Handbook (BMP Handbook). You must select at least one BMP for each performance standard to meet the minimum requirements. Please refer to the BMP Handbook to assist you in selecting BMPs for your site. It is the responsibility of the person who fills out this checklist to ensure that the BMPs selected are included in the contract bid documents and implemented at the site. If your project or site has characteristics that make meeting a performance standard infeasible or inapplicable (e.g. size of site, slope of site), please explain these characteristics at the bottom of the form.

Performance Standard	Check if Selected	BMPs	Comments
1 - Schedule construction and minimize clearing and grading	<input type="checkbox"/>	PL-1 Site Design	
	<input type="checkbox"/>	PL-2 Scheduling	
	<input type="checkbox"/>	PL-3 Phased Construction	
	<input type="checkbox"/>	PL-4 Topsoil Reuse	
	<input type="checkbox"/>	EC-1 Preserve Natural Vegetation	
2 - Stabilize disturbed areas	<input type="checkbox"/>	EC-2 Slope Terracing and Tracking	
	<input type="checkbox"/>	EC-3 Mulching	
	<input type="checkbox"/>	EC-4 Soil Binders	
	<input type="checkbox"/>	EC-5 Wind Erosion and Dust Control	
	<input type="checkbox"/>	EC-6 Rolled Erosion Control Products	
	<input type="checkbox"/>	EC-8 Revegetation	
3 - Protect slopes	<input type="checkbox"/>	RC-2 Temporary Dikes and Ditches	
	<input type="checkbox"/>	RC-4 Temporary Slope Drains	
	<input type="checkbox"/>	EC-2 Slope Terracing and Tracking	
	<input type="checkbox"/>	EC-4 Soil Binders	
	<input type="checkbox"/>	EC-6 Rolled Erosion Control Products	
	<input type="checkbox"/>	EC-7 Riprap	

Truckee Meadows Regional Stormwater Quality Management Program

Performance Standards Compliance Checklist

Performance Standard	Check if Selected	BMPs	Comments
	<input type="checkbox"/>	EC-8 Revegetation	
	<input type="checkbox"/>	SC-1 Fiber Rolls	
	<input type="checkbox"/>	SC-2 Brush and Rock Filters	
	<input type="checkbox"/>	SC-3 Sand Bag Barriers	
	<input type="checkbox"/>	SC-4 Gravel Filter Berm	
	<input type="checkbox"/>	SC-11 Synthetic Sed Control Rolls	
	<input type="checkbox"/>	SC-12 Compost Filter Berms	
	<input type="checkbox"/>		
	<input type="checkbox"/>		
	<input type="checkbox"/>		
	<input type="checkbox"/>		
4 - Design conveyance for non-erosive velocities	<input type="checkbox"/>	RC-1 Permanent Diversions	
	<input type="checkbox"/>	RC-2 Temporary Dikes and Ditches	
	<input type="checkbox"/>	RC-3 Check Dams	
	<input type="checkbox"/>	DP-2 Stormdrain Outlet Protection	

Truckee Meadows Regional Stormwater Quality Management Program

Performance Standards Compliance Checklist

Performance Standard	Check if Selected	BMPs	Comments
5 - Protect waterways, natural drainages and storm drains	<input type="checkbox"/>	PL-1 Site Design	
	<input type="checkbox"/>	RC-2 Temporary Dikes and Ditches	
	<input type="checkbox"/>	EC-1 Preserve Natural Vegetation	
	<input type="checkbox"/>	SC-1 Fiber Rolls	
	<input type="checkbox"/>	SC-2 Brush and Rock Filters	
	<input type="checkbox"/>	SC-3 Sand Bag Barriers	
	<input type="checkbox"/>	SC-4 Gravel Filter Berm	
	<input type="checkbox"/>	SC-5 Silt Fences	
	<input type="checkbox"/>	SC-11 Synthetic Sed Control Rolls	
	<input type="checkbox"/>	SC-12 Compost Filter Berms	
	<input type="checkbox"/>	DP-1 Temporary Stream Crossing	
	<input type="checkbox"/>	DP-2 Stormdrain Outlet Protection	
	<input type="checkbox"/>	DP-3 Stormdrain Inlet Protection	
	<input type="checkbox"/>	DP-4 Catch Basin Inlet Filters	
6 - Install sediment traps and retain sediment caused by erosion on site	<input type="checkbox"/>	RC-3 Check Dams	
	<input type="checkbox"/>	SC-1 Fiber Rolls	
	<input type="checkbox"/>	SC-2 Brush and Rock Filters	
	<input type="checkbox"/>	SC-3 Sand Bag Barriers	
	<input type="checkbox"/>	SC-4 Gravel Filter Berm	
	<input type="checkbox"/>	SC-5 Silt Fences	
	<input type="checkbox"/>	SC-6 Temporary Sediment Traps	
	<input type="checkbox"/>	SC-7 Sediment Retention Basins	
		SC-11 Synthetic Sed Control Rolls	

Truckee Meadows Regional Stormwater Quality Management Program

Performance Standards Compliance Checklist

Performance Standard	Check if Selected	BMPs	Comments
	<input type="checkbox"/> <input type="checkbox"/> <input type="checkbox"/> <input type="checkbox"/> <input type="checkbox"/>	SC-12 Compost Filter Berms	
7 - Remove accumulated sediment	<input type="checkbox"/>	Standard Note No. 5	
8 - Control site entrances and exits	<input type="checkbox"/>	SC-8 Site Entrances/Exits	
	<input type="checkbox"/>	SC-9 Construction Exit Tire Wash	
	<input type="checkbox"/>	SC-10 Stabilized Construction Road	
	<input type="checkbox"/>	GM-5 Street Sweeping	
9 - No storage on paved roadways	<input type="checkbox"/>	GM-2 Stockpile Management	
	<input type="checkbox"/>	GM-3 Solid Waste Management	
	<input type="checkbox"/>	GM-10 Material Delivery and Storage	
	<input type="checkbox"/>	GM-15 Landscaping Management	

Truckee Meadows Regional Stormwater Quality Management Program

Performance Standards Compliance Checklist

Performance Standard	Check if Selected	BMPs	Comments
10 - Manage materials and wastes	<input type="checkbox"/>	GM-3 Solid Waste Management	
	<input type="checkbox"/>	GM-6 Spill Prevention and Control	
	<input type="checkbox"/>	GM-9 Disposal of Concrete/Cement	
	<input type="checkbox"/>	GM-10 Material Delivery and Storage	
	<input type="checkbox"/>	GM-11 Paints and Liquids	
	<input type="checkbox"/>	GM-13 Liquid Waste Management	
	<input type="checkbox"/>	GM-14 Sanitary/Septic Waste Mgmt	
	<input type="checkbox"/>	GM-15 Landscaping Management	
	<input type="checkbox"/>	GM-16 Contaminated Soil/Water	
11 - Manage equipment and vehicles	<input type="checkbox"/>	GM-7 Vehicle and Equipment Cleaning	
	<input type="checkbox"/>	GM-8 Vehicle and Equipment Maintenance	
12 - Permanent stabilization	<input type="checkbox"/>	PL-4 Topsoil Reuse	
	<input type="checkbox"/>	EC-3 Mulching	
	<input type="checkbox"/>	EC-4 Soil Binders	
	<input type="checkbox"/>	EC-6 Rolled Erosion Control Products	
	<input type="checkbox"/>	EC-7 Riprap	
	<input type="checkbox"/>	EC-8 Revegetation	
	<input type="checkbox"/>	SC-1 Fiber Rolls	
	<input type="checkbox"/>	SC-12 Compost Filter Berms	

Explanation why performance standard(s) cannot be met:

Truckee Meadows Regional Stormwater Quality Management Program

Performance Standards Compliance Checklist

TRUCKEE MEADOWS REGIONAL STORMWATER QUALITY MANAGEMENT PROGRAM

CONSTRUCTION SITE INSPECTION CHECKLIST

The contractor or other responsible party shall inspect the site at a minimum weekly, prior to forecasted rain events and within 24 hours of any rain event that creates runoff at the site. Inspection checklists shall be maintained onsite for review by State and local government inspectors.

Project Name

and File Number: _____

Project Location: _____

Date: _____ **Inspected by:** _____

(Name and Company)

Type of Inspection: Routine Pre-Storm Post-Storm

Yes No N/A

- | | | | |
|--------------------------|--------------------------|--------------------------|---|
| <input type="checkbox"/> | <input type="checkbox"/> | <input type="checkbox"/> | 1. Has there been rain since the last inspection? |
| <input type="checkbox"/> | <input type="checkbox"/> | <input type="checkbox"/> | 2. Are roadways, storm drains, watercourses or swales or channels leading offsite free of sedimentation, litter, wastes and hazardous materials? |
| <input type="checkbox"/> | <input type="checkbox"/> | <input type="checkbox"/> | 3. Have all denuded areas requiring temporary or permanent stabilization been stabilized? |
| <input type="checkbox"/> | <input type="checkbox"/> | <input type="checkbox"/> | 4. Does the stabilization BMP cover the area intended? |
| <input type="checkbox"/> | <input type="checkbox"/> | <input type="checkbox"/> | 5. Are all sediment barriers (e.g. sandbags, silt fences) in place according to the grading plans or subsequent plan update and are they installed and functioning correctly? |
| <input type="checkbox"/> | <input type="checkbox"/> | <input type="checkbox"/> | 6. If sediment basins are used, is there 50% or more capacity remaining? |
| <input type="checkbox"/> | <input type="checkbox"/> | <input type="checkbox"/> | 7. Are water diversion structures functioning adequately with appropriate outlet protection and no evidence of erosion from their discharge? |
| <input type="checkbox"/> | <input type="checkbox"/> | <input type="checkbox"/> | 8. Are onsite channels stabilized? |
| <input type="checkbox"/> | <input type="checkbox"/> | <input type="checkbox"/> | 9. Do all onsite and adjacent storm drain inlets have inlet protection? |

- 7. Are all watercourse and vegetation protection measures in place and adequately maintained?
- 8. Are all materials and equipment not in use located in designated storage and maintenance areas?
- 9. Are all material and equipment storage and maintenance areas reasonably clean and free of spills, leaks or other sources of potentially polluting materials?

TRUCKEE MEADOWS REGIONAL STORMWATER QUALITY MANAGEMENT PROGRAM

CONSTRUCTION SITE INSPECTION CHECKLIST

Page ___ of ___

- 10. Are all BMPs installed according to the specifications in the Truckee Meadows Construction Site BMP Handbook?
- 11. Are all the BMPs identified on the Performance Standards Checklist functioning properly and adequately maintained?
- 12. Are the BMPs being utilized adequate to manage erosion, sedimentation and other construction site pollutants?

If you answered NO to any of the above questions (except Number 1), describe any corrective actions that must be taken to remedy the problem and when the corrective action is to be taken.

Checklist Item	Corrective Action Needed	Date to be Completed

Appendix E
Regional Seed Mix Designs

TRUCKEE MEADOWS REGIONAL STORMWATER QUALITY MANAGEMENT PROGRAM

This section is meant to provide guidance on potential revegetation seed mixes appropriate for use in Northern Nevada. If there is a seed type that is not available, and a substitution or addition needs to be made, please consult with your project manager for approval.

In non-residential areas, the use of a full suite of seeds is recommended for habitat values. However, in an urban area, professionals encourage the use of these seed mixes listed in Appendix E, to protect human health and property.

The following seed mixes are generally approved for Northern Nevada soil types, but an owner, developer, consultant, or contractor should always consult with a licensed professional before installation to be certain the seed mix he/she chooses is appropriate and acceptable for the conditions.

FIRE-RESISTANT SEEDS ONLY

Generic Revegetation Seed Mix for Upland Sites in Northern Nevada

Botanical Name	Common Name	PLS (lbs/acre)
<i>Firesafe seeds:</i>		
Achillea millefolium	Yarrow	0.10
Achnatherum hymenoides	Indian ricegrass "Nezpar/Native"	2.25
Agropyron fragile ssp. Sibericum	Siberian wheatgrass "P-27"	4.75
Elymus elymoides	Bottlebrush Squirreltail	3.50
Elymus lanceolatus	Streambank wheatgrass "Sodar"	4.25
Erigonum umbellatum	Sulfurflower buckwheat	0.50
Festuca ovina	Sheep fescur "Covar"	2.25
Linum lewisii	Blue flax	0.50
Lupinus argenteus	Silverleaf lupine	0.50
Penstemon palmeri	Palmer penstemon	0.25
Poa secunda	Sandberg bluegrass "Sherman"	2.25
Psuedoroegneria spicata	Bluebunch wheatgrass "Secar"	3.50
	Annual flower blend	0.50
	Annual ryegrass	5.75
TOTAL		30.85

FIRE-RESISTANT SEEDS ONLY

Saline/Sodic Upland Sites in Northern Nevada

Botanical Name	Common Name	PLS (lbs/acre)
Firesafe seeds:		
Agropyron sibericum	Siberian wheatgrass "P-27"	4.00
Elymus elymoides	Squirreltail	4.00
Elymus lanceolatus	Streambank wheatgrass "Sodar"	4.25
Kochia prostrata	Prostrate summer cypress	0.25
Leymus cinereus	Great Basin wildrye	2.50
Penstemon palmeri	Palmer penstemon	1.00
	Annual ryegrass	6.25
TOTAL		22.25

FIRE-RESISTANT SEEDS ONLY

Generic Revegetation Seed Mix for Wet Saline/Sodic Sites in Northern Nevada

Botanical Name	Common Name	PLS (lbs/acre)
<i>Firesafe seeds:</i>		
Dichtichlis stricta	Inland Saltgrass	3.10
Elymus lanceolatus	Streambank wheatgrass "Sodar"	3.10
Elytrigia elongata	Tall wheatgrass, "Jose"	4.30
Hordeum jubatum	Meadow foxtail	2.00
Juncus balticus	Baltic rush	0.20
Leymus cinereus	Great Basin wildrye, "Magnar"	5.75
Leymus triticoides	Creeping wildrye, "Shoshone"	5.75
Puccinellia lemmonii	Alkali grass	0.50
Sporobolus airoides	Alkali sakaton	0.50
TOTAL		25.20

Generic Revegetation Seed Mix for Upland Sites in Northern Nevada

Botanical Name	Common Name	PLS ¹ (lbs/acre)
<i>Achillea millefolium</i>	Yarrow	0.10
<i>Achnatherum hymenoides</i>	Indian ricegrass "Nezpar/Native"	2.00
<i>Agropyron fragile</i> ssp. <i>sibericum</i>	Siberian wheatgrass "P-27"	4.00
<i>Artemisia tridentata</i> ssp. <i>wyomingensis</i> ²	Basin sagebrush	1.00
<i>Chrysothamnus nauseosus</i> ²	Rabbitbrush	0.50
<i>Elymus elymoides</i>	Bottlebrush squirreltail	3.00
<i>Elymus lanceolatus</i>	Streambank wheatgrass "Sodar"	4.00
<i>Ephedra viridis</i>	Mormon tea	0.50
<i>Eriogonum umbellatum</i>	Sulfurflower buckwheat	0.50
<i>Festuca ovina</i>	Sheep fescue "Covar"	2.00
<i>Linum lewisii</i>	Blue flax	0.50
<i>Lupinus argenteus</i>	Silverleaf lupine	0.50
<i>Penstemon palmeri</i>	Palmer penstemon	0.25
<i>Poa secunda</i>	Sandberg bluegrass "Sherman"	2.00
<i>Psuedoroegneria spicata</i>	Bluebunch wheatgrass "Secar"	3.00
<i>Purshia tridentata</i>	Bitterbrush	1.00
	Annual flower blend ³	0.50
	Annual ryegrass	5.00
TOTAL		30.35

Notes:

1. PLS = Pure Live Seed
2. Seeds have a short shelf life
3. Annual flower blend contains *Centaurea cyanus* (Bachelor buttons), *Cleome lutea* (Beeplant), *Cosmos bipinnatus* (Cosmos), and *Helianthus annuus* (Sunflower)

Generic Revegetation Seed Mix for Saline/Sodic Upland Sites in Northern Nevada

Botanical Name	Common Name	PLS ¹ (lbs/acre)
Agropyron sibericum	Siberian wheatgrass "P-27"	3.00
Artemisia tridentata ssp wyomingensis ²	Basin sagebrush	0.50
Atriplex canescens	Four-wing saltbrush	2.00
Atriplex confertifolia	Shadscale saltbrush	1.00
Atriplex lentiformis	Quailbush	1.00
Chrysothamnus nauseosus ²	Rabbitbrush	0.50
Elymus elymoides	Squirreltail	3.00
Elymus lanceolatus	Streambank wheatgrass "Sodar"	3.00
Grayia spinosa	Spiny hopsage	0.50
Kochia prostrata	Prostrate summer cypress	0.25
Leymus cinereus	Great Basin wildrye	2.00
Penstemon palmeri	Palmer penstemon	0.50
	Annual ryegrass	5.00
TOTAL		22.25

Notes:

1. PLS = Pure Live Seed
2. Seeds have a short shelf life

Generic Revegetation Seed Mix for Wet Saline/Sodic Sites in Northern NV

Botanical Name	Common Name	PLS ¹ (lbs/acre)
Artemisia tridentata Ssp tridentata	Big sagebrush	1.00
Distichlis stricta ²	Inland saltgrass	3.00
Elymus lanceolatus	Streambank wheatgrass "Sodar"	3.00
Elytrigia elongata	Tall wheatgrass, "Jose"	4.00
Hordeum jubatum	Meadow foxtail	2.00
Juncus balticus ³	Baltic rush	0.20
Leymus cinereus	Great Basin wildrye, "Magnar"	5.00
Leymus triticoides	Creeping wildrye, "Shoshone"	5.00
Puccinellia lemmonii	Alkali grass	0.50
Sarcobatus vermiculatus	Greasewood	1.00
Sporobolus airoides	Alkali sakaton	0.50
TOTAL		25.20

Notes:

1. PLS = Pure Live Seed
2. If seeded in spring, pre-treat seed to reduce dormancy and irrigate
3. High seed dormancy